

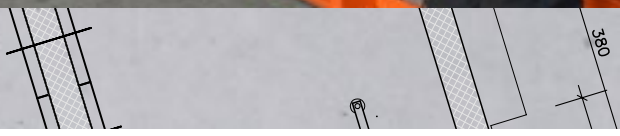

# PASCHAL-Manual

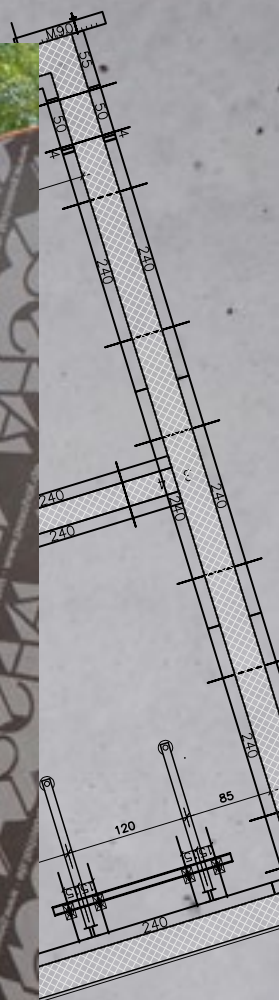
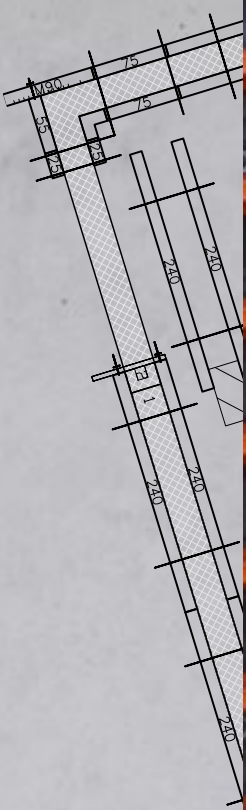

**01.2022**

printed in Germany

Subject to technical change

Important remarks:

Photos printed in this manual show actual situation at sites; for this reason security installations are not always complete. At use of PASCHAL Systems the corresponding technical information has to be considered.



		page	chapter
<b>Welcome at PASCHAL</b>		4	1
<b>Service and consultation</b>		12	2
<b>Wall formwork</b>	Modular/GE universal formwork	22	3
	Lightweight formwork NeoR	38	4
	Wall formwork LOGO.3	48	5
	Wall formwork LOGO.alu	80	6
	Wall formwork LOGO.pro	84	7
	Wall formwork LOGO.S	92	8
<b>Circular Trapezoidal girder formwork</b>	TTR Circular Trapezoidal girder formwork	96	9
	TKK Circular Trapezoidal girder formwork with clamp connection	112	10
	TTS Circular Trapezoidal girder formwork with steel facing	116	11
<b>Column formwork</b>	Grip	124	12
	Circular column formwork	130	13
	Modular column formwork adjustable	134	14
	Column formwork (Modular, LOGO)	136	15
<b>Slab formwork</b>	PASCHAL Deck	138	16
	Slab edge formwork	146	17
<b>Climbing &amp; platforms</b>	Climbing system 240	148	18
	Climbing systems 200	151	19
	Climbing platform KBK 180	152	20
	Dam bracket SPK 270	154	21
	Lifting platforms	156	22
<b>Occupational safety</b>	Secuset Lateral protection system	162	23
	Multip Multi-functional working platform	168	24
<b>Shoring systems</b>	GASS Aluminium shoring system	176	25
	PASCHAL TG 60	186	26
<b>Wall formwork others</b>	Compatibility	198	27
	Single-sided forming	204	28
	Supports and consumption material	212	29
<b>Custom formwork</b>		218	30
<b>Software</b>	PASCHAL Maturix	226	31
	PPL 12.0 · PPPro · planitec AR app · ERPrental · Checkinsite	230	32
	PASCHAL Ident	240	33
<b>System summary</b>		246	A
<b>Concrete pressure</b>		254	B
<b>Sales organisation</b>	International	262	C
	Germany	267	D
<b>Register</b>		270	E

# Welcome at PASCHAL!







*Dr.-Ing. Dr.rer.pol. Marius Wunder, Managing Director*

This manual is the comprehensive compendium of the PASCHAL formwork universe.

Until quite recently, I myself was a „newcomer“ to the world of concrete formwork and can now verify that this is the reference book for beginners and professionals alike.

As a customer of PASCHAL, you have a passion for modern concrete construction, which is why we at PASCHAL, as a leading service provider, always aim to provide you with a clear overview of the latest innovations and solutions from our product portfolio.

This manual completes our mission to provide you with innovative and durable quality products made in Germany, which we have done for over 50 years now, and to provide you with comprehensive support for both large and small construction projects worldwide.

Our vision: Together, we provide the world with concrete in any shape and form!











Headquarter in Steinach; 1964

## From the early beginnings . . .

For over 50 years PASCHAL has proven its experience and proficiency in wood and metal processing. In 1964, at the age of 55 years, Josef Maier together with his wife Gertrud founded „G. Maier Metallverarbeitung“ in Baden, Germany. Back then he realized that work on construction sites could be carried out much faster and a lot more cost-efficient by using a systematic approach. The wholesale firm „Baustoff-großhandlung Josef Maier“ dealing with construction materials has been operating since 1904. It was now complemented by an independent formwork provider.

„Standard Schalung“ (standard formworks) was the first patented concrete formwork by PASCHAL. The builders, who used this new concept, called it „patente Schalung“ (clever formworks). Soon the name was shortened, and then became the name under which the company became known: PASCHAL.

Ever since then, we have continued developing clever formwork systems, which are ideally suited for requirements of continuously increasingly complex construction sites. The systems are designed in such way that they can be adapted to any kind of construction site. This allows us to provide optimised support for our clients for all their construction projects.

## . . . to the present

The PASCHAL-Group is a leading manufacturer of formwork modules and supportscaffolding systems for modern concrete construction. The enterprise, family controlled for the past three generations, belongs to the best known providers in its field on a world-wide basis and cooperates with numerous trade partners. The range of products comprises the manufacturing and the distribution of concrete shuttering, supporting system and formwork software together with a comprehensive service program covering the entire concrete construction range.

Production processes that monitor quality



Josef Maier with the Order of the Federal Republic of Germany



Barbara R. Vetter, Managing Director

and distribution centers in the strategically most important world markets make sure that PASCHAL's clients and partners will get the best solutions for their construction project in the shortest possible time.

PASCHAL combines their excellent development competence with professional advice and accompanies individual projects. This results in technically advanced series-made products but also in custom-made products made of steel that are tailor-made to suit customer's specifications. Advisory- and customer services are provided on-site: That is the way PASCHAL makes its globally coordinated expertise available to its clients.



## 1 ... into the future

It is PASCHAL's aim to provide their customers with technically sound and fully developed products at any time, on the basis of the latest technological standards.

Consequent orientation towards current and future market trends ensures that formwork and shoring systems can be adapted perfectly to construction requirements. Today our formwork products contribute to accentuate internationally the brand PASCHAL as sign of quality.

Systematic alignment with current and future market requirements ensures that formwork and support systems can be ideally adapted to actual construction requirements. Our success proves this strategy right: The core products of the PASCHAL product range prove their value daily in hundreds of demanding building projects. Complete solutions, customised right down to the smallest planning and formwork details according to the needs of the customer mean that no additional work on site is necessary, thus enabling valuable savings in time and material budgets.

PASCHAL's customers are particularly interested in the Neor lightweight formwork and Modular/GE universal formwork for nearly all standard formwork tasks, the LOGO.3 and LOGO.pro wall formwork with one-sided formwork anchors, circular formwork, column forms, climbing systems and single-sided formwork, as well as support systems for pre-fabricated and in-situ concrete ceilings and custom formwork, manufactured especially in accordance with the customer's wishes.

State-of-the-art software solutions are used for optimized shuttering plans ranging from site-planning to the organization of the inventory. Starting off with automated formwork planning using PASCHAL-Plan light and continuing with differentiated AutoCAD formwork planning with PASCHAL-Plan pro, right up to using the RFID (Radio Frequency Identification) process with PASCHAL Ident for the organization and administration of modern formwork parks. Even during the concreting process, PASCHAL supports its customers with PASCHAL Maturix for intelligent concrete strength monitoring in real-time.

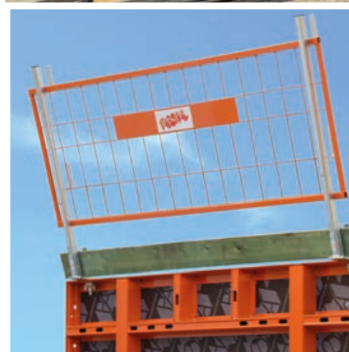
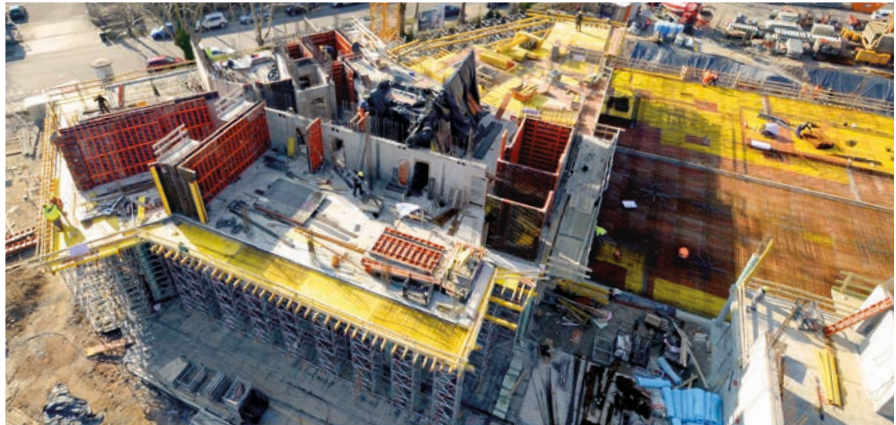



## The Difference

How is PASCHAL different from other providers?

On the one hand, we offer comprehensive solutions, including the most minute planning and formwork details. Those little 'gap fillers' (additional formwork) up to 20 cm in length, which generally do not appear in any tender document, but are nevertheless every day stop-gaps on many building sites, are never needed when PASCHAL is on-site. We use system integrated compensation elements instead, to close any gaps quickly and cost-effectively. The time and material saved in this manner, contributes significantly towards optimising formwork time, and therefore the success of your constructions.

The extraordinary lifetime of PASCHAL formworks bear testament to their extraordinary product quality. We know of some formwork elements that have been deployed a couple of thousand times, and are still going strong.

You will understand the difference right away, when you talk to your PASCHAL expert consultant. His main interest will be your continued satisfaction. Your project is his project.

Buying a PASCHAL product is the foundation, on which long-term and successful partnerships are based. Dealing with all those seemingly insignificant details results in significant benefits for our customers! That is our goal.



Have you already seen it?



PASCHAL Image film  
Our passion is formwork  
for the optimum concrete construction!  
It's worth taking a look!



## Our Values

### Customer Satisfaction

Taking their lead from our headquarters in Steinach/Baden, all employees of the PASCHAL family take on their own responsibility to provide the best possible service to our clients wherever they may be in the world, and to guarantee their satisfaction. This includes providing the best products for the type of formwork required, the best formwork plans, the friendliest and most competent consulting, and many more service offerings for formworks and construction sites in general.

### Protecting the Environment

For PASCHAL taking on responsibility includes the environment too. Choosing sustainable quality control procedures that result in long-lasting formwork modules and support systems are an important contribution to a responsible handling of natural resources.

### Health & Safety

The health and safety of those who use PASCHAL products, of our service providers and of course of our employees are a major concern of ours. For all of our products, health and safety concerns play a major role even as early as the development phase. Decades of experiences gained in our research and development work, but also feedback from our clients are important considerations for our product developments. That is how safe formwork systems for worldwide deployment have always been developed here, and will continue to be developed in the future.

The safeguards employed in our production facilities and processes far surpass legal requirements. Periodic inductions and training sessions for our personnel additionally support our policy to provide a safe and healthy work environment for everyone. We consider these measures to be an important component of our constant improvement process (CIP).

### Social Responsibility

PASCHAL stands for social responsibility in regards to the communities that we are part of wherever our facilities and subsidiaries may be. We support social and cultural institutions and sport events for everyone. And we enjoy our responsibilities with conviction and help, wherever we can.

### Our team

The knowledge and experience of our employees drives PASCHAL forwards. The long Periods of employment of our employees have shown that a good working environ-

ment and trust are essential for successful and long-term collaboration.

Committed employees, whether they are in a team or in project work, are a guarantee for providing the best advice, service and close customer contact, in short they are essential for the success of PASCHAL. At our sites, each and every one of our employees is a representative of our company name, our service and our quality. We do not take this level of performance from each and every person for granted and we really appreciate it!

For more than fifty years, we have achieved a lot together. High-grade construction projects are testimony to this joint success story.



PASCHAL supports, among others, the soccer players of the DJK Welschensteinach.





## Quality Control

PASCHAL products are known for their good quality. We take great care to develop functional design, choose first class materials and realize top-class manufacturing quality and this line is kept throughout the entire range of products and also applies to new developments. This way, formworks, support systems and accessories are created, which are easy to handle and possess extreme longevity. PASCHAL formwork panels may be deployed several thousand times over: this combines successful construction jobs with excellent security of investment.

PASCHAL's quality control is DIN EN ISO 9001:2015 certified and is continually being updated. PASCHAL also stands for internationally binding quality control, not least of all as a founding member of the "Deutscher Güteschutz-Verband Betonschalungen GSV e. V." [German Association to safeguard the quality of formwork].

A decisive factor for the successful deployment of PASCHAL products for modern concrete construction is the extensive experience of PASCHAL teams that are always actively feeling the pulse of the modern construction industry. PASCHAL is aware of the demands posed by today's concrete construction projects down to the tiniest detail. PASCHAL's new developments are subjected to the most stringent criteria with regards to customer's benefit and sustainability. Consequent training of staff with regular training programs and schemes of further education safeguards the consistently high level of PASCHAL products and services.

The Quality Protection Association Concrete Formwork was founded in 1992. The principal aim of this association is the promotion of partnership conditions between users and suppliers of concrete formwork as well as development and quality assurance in formwork technology. The members of the association are well-known formwork companies and some formwork users from Germany, Austria and Switzerland.

According to the principal aim rules and standards for construction, dimension and use of concrete formwork are worked out and published within the bounds of the association. The collaboration in formulation of standards on national and international level is of special significance.



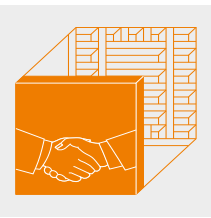

# Service

Consulting & Support



## All-round service for your formwork project

PASCHAL offers reliable and rapidly available services internationally for everything related to formwork and shoring systems. Thanks to our versatile on-site service, we can implement your formwork construction projects successfully and efficiently with our high-quality formwork products. We can provide construction project solutions that are implemented hand-in-hand by our technical specialists. Engineers, Application engineers and Fitters work together to create the optimum formwork solution.

Our service teams provide outstanding technical solutions to ensure the successful progress of your formwork project.



## Consulting & Support

Our service starts directly at your site: The PASCHAL specialist consultants and our trade partners are your first points of contacts for creating an efficient formwork solution.

They are supported by the staff from our expert sales team (domestic and export) and the PASCHAL project team. Our sales organisation is unique. Someone from the PASCHAL team is always on hand nearby. By integrating production, work preparation and material planning into your projects early on, we ensure on-time deliveries, even for larger projects.

**Your project is our project.**

### Formwork consultants

All our PASCHAL consultants have in-depth knowledge and a wide range of expertise and experience to assist you in the most complex formwork projects.

No matter, whether you have queries regarding cost estimates for your own calculations, developing concreting phases, or inclusion of your existing formwork material: he will be your partner, who is less interested in short-term benefits, than more in your own long-term satisfaction.

His priority is that your construction site will function seamlessly, once all deliveries have been completed, and will ensure smooth processes with personal visits on-site, where required.

Formwork specialists from PASCHAL trade partners will round off or take on this particular service. These partners also regularly take part in intensive PASCHAL training courses.

### Customer-focussed full service

- Competent advice and building site support
- BIM-supported formwork operations planning
- Structural calculations for formwork operations
- Warehouses for new material, with delivery reliability and follow-up purchase certainty
- Special constructions, special formwork and building-specific formwork pre-assembly
- Extensive rental parks with reliable logistics
- PASCHAL fitters to provide instructions on the building site
- Cleaning of hired formwork and customer-owned formwork
- Formwork planning software PASCHAL-Plan light and PASCHAL-Plan pro
- AR app for the detailed visualisation of the current state of planning
- Online Customer Portal checkinsite
- Repairs, renovation and general overhaul
- Seminars and training courses
- Purchase from hiring, hire-purchase, financing solutions
- Leasing formwork



*Personally on the spot, whenever and wherever you need him: your PASCHAL consultant*





## Application Engineering

### You can always rely on our team

The PASCHAL application engineering department consists of a team of experienced application technicians and engineers, who deal with special customer requirements. After your initial contact with the PASCHAL consultant, the team starts working on an optimised solution for your particular project.

### We always find the best solution for your formwork construction project

Our solution approaches are provided free of charge to you during the proposal stage. Our application engineering team will also be supporting you during the whole life cycle of the construction project. Their objective is to provide you with the quickest, most attractive, most low-maintenance, cost-effective and simplest solution according to your specifications.

### Static calculations for formwork operations available if required

In addition to CAD generated formwork drawings, phases, and material lists, PASCHAL application engineering will also provide you with structural calculations for formwork deployment on request. In close cooperation with the PASCHAL custom formwork and the construction department, we develop solutions, which also cover topics beyond the combination of serial system components.

## Technicians & Formwork Fitters

Experienced PASCHAL technicians convey important practical knowhow to their forming crews on site. An important aspect not only in complex formwork applications with e.g. jacking technology - because our PASCHAL technicians don't mind getting their hands dirty!





## Leasing Service

### Rental logistics: Powerful and reliable

**Are you looking for formwork for rent, for example because your own stock of formwork elements is exhausted?**

The rent material warehouses at the PASCHAL main facility, at the PASCHAL branch offices, and at the numerous PASCHAL trade partner locations will be able to satisfy peak demands, or deliver all formwork requirements for your construction sites. Our reliable network guarantees high availability, short delivery times, and low-cost transport.

#### Formwork panels, formwork accessories and shoring for rental

Everything you lease from us, including formwork panels, accessory or supports, complies with quality requirements for leased formwork issued by the Quality Protection Association Concrete Formworks GS. Furthermore, we apply our own stringent quality guidelines, which means that you will always have impeccable material at your disposal.

### Optimal logistical workflows

Result-oriented employees, transparent business processes, and reliable freight carriers are the basis for timely and smooth deliveries as well as reliable transactions when handling returns.

Simple and complex projects are all handled by a custom rental software, specifically designed for this purpose. It provides transparency of processes, as well as traceability for all rental movements and invoicing.

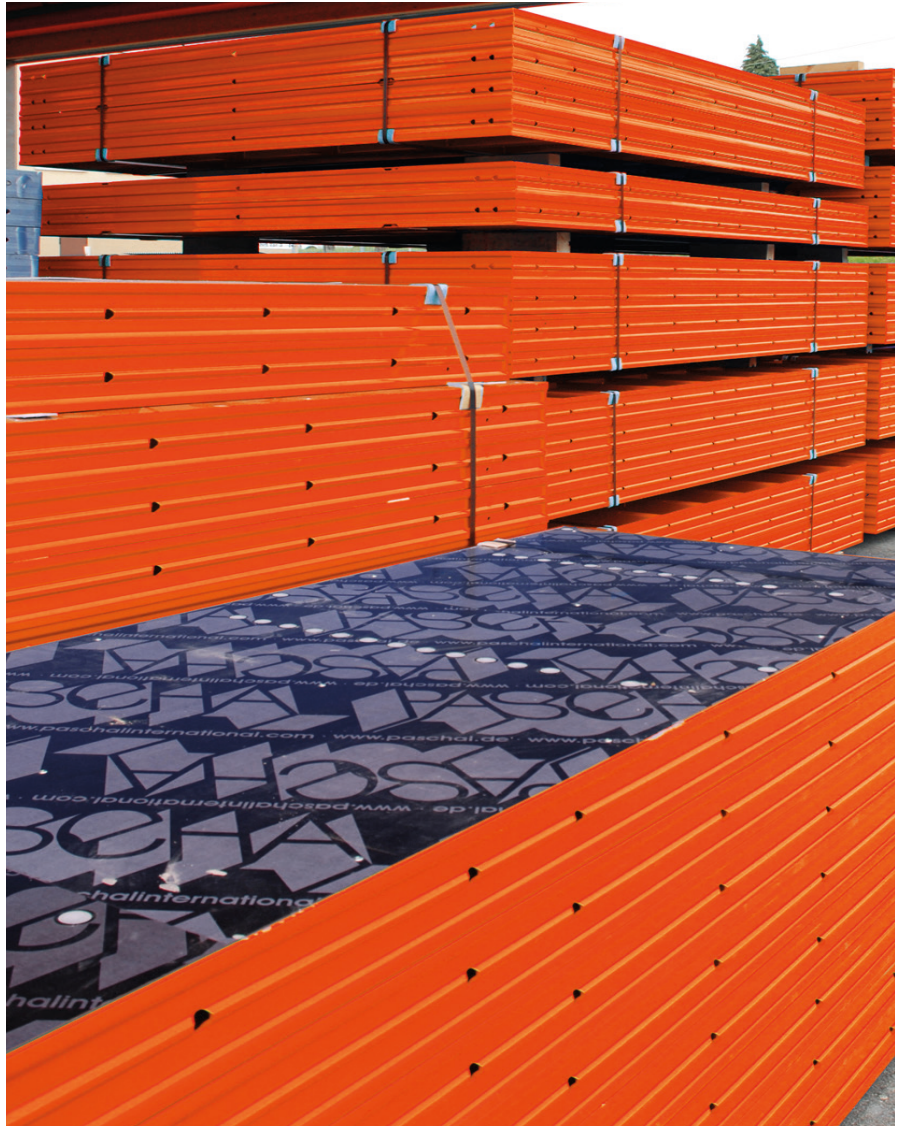





## Cleaning & Repair

Cleaning of the formwork elements in industrial cleaning facilities is more cost-effective and efficient than on-site cleaning. We will be happy to provide this additional service for you. If you have PASCHAL taking care of the cleaning of the formwork elements, you will be able to return them faster, therefore shortening your lease period.

PASCHAL system formwork elements are known for their sturdiness and longevity. Particularly the solid flat steel frames for the Modular/GE universal formwork, NeoR lightweight formwork and LOGO formwork are practically impervious to mechanical damage, and easy to repair.



BEFORE and AFTER the renovation

## Renovation and general overhaul

### Renovation

During renovations, new original plywood linings are installed, and expansion joints are filled with a special PASCHAL jointing compound. All elements are checked and measured.

The high quality PASCHAL replacement plywood linings manufactured from multi-layered Nordic birch plywood, offer an excellent price-performance ratio. If they are maintained in accordance with recommendations, they will withstand significantly more applications than cheaper plywood with questionable specifications, and are therefore more economical in the long run. The OEM replacement plywood linings are pre-milled (bushed, where required), and edged. You can install the original PASCHAL replacement plywood linings yourself, or PASCHAL can do it for you at our facility.

### General overhaul

If welding and soldering work will be required, a general overhaul should be scheduled. A general overhaul will include checking, cleaning, sand blasting, aligning, re-welding and base coating of all frames. Afterwards, new original plywood linings are installed, and expansion joints are filled with a special PASCHAL jointing compound.

While thin-wall, hollow profile formworks can often not be refurbished at reasonable cost, the flat steel frame formworks from PASCHAL are ideally suited for general overhauling. The life expectancy of PASCHAL formwork elements can be almost doubled.



BEFORE and AFTER the general overhaul



## PASCHAL system formwork in your company colour

Corporate colors contribute significantly to a corporate identity and are an important marketing instrument - even in the construction industry. That which was initially only possible for large vehicles is now also available for concrete formwork.

For several years now, PASCHAL has been delivering concrete formwork, where requested, in any color that the respective customer desires, rather than in their own production color, orange. This is typically the corporate color of the customer. Colours can be chosen from the RAL palette, from a range of a few hundred matt and glossy colours. This means that almost every company colour can be ordered.





## Seminars and training courses



PASCHAL construction seminar

In today's highly competitive industry, corporate success depends on construction specialists being well informed about formwork systems and on deploying these effectively and efficiently.

PASCHAL seminars provide participants with key know-how on the optimised use of PASCHAL systems and expertise from various construction fields. We share information and practical tips on topical issues relating to standards, techniques, products and construction methods so that you are always well equipped to master your daily tasks.

**PASCHAL offers seminars, training courses, advanced training and factory tours for the following target groups:**

- Building contractors, construction managers, foremen, planning engineers, specialist workers
- Architects, structural engineers, engineers, works and specialist planners
- Business partners
- Universities, technical colleges, training centres and vocational schools



Training course at the headquarters in Steinach

### Important formwork expertise in theory and practice

PASCHAL seminars are not held for advertising purposes. The seminars inform about how PASCHAL systems can be deployed most effectively, and also impart expert knowledge in the field of construction engineering far beyond mere formworks technology.

All of the PASCHAL systems have been constructed with practical example solutions in the exhibition hall at the PASCHAL headquarters.

Ask us about a visit to the exhibition hall the next time you come to our plant.



Exhibition hall





# Formwork

Standard formwork





## Efficient and safe

PASCHAL standard and custom formwork have been optimized for an optimum Cost-Benefit ratio: System solutions for formwork must be perfectly adapted for any type of building project. It must be modular and it must be suitable for repeated use. Development also focuses on optimum handling qualities – for an increase in safety, versatility and efficiency in modern concrete constructions.

PASCHAL offers wall formwork that is perfectly matched to any type of application: The TTR, TTK and TTS circular formwork with trapezoidal girders have been specifically designed with round walls in mind. The NeoR and Modular Universal Formwork, available in numerous dimensions and compatible with large-size elements, is suitable for small, tall and complicated concrete shapes. Large-area walls can be realized with the large-size formwork LOGO.3 and LOGO.pro with one-sided anchor system, while building sites without crane are served with the light-weight LOGO.alu version.



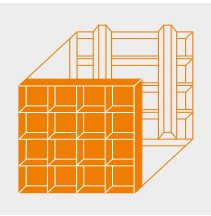

# Modular/GE

Universal Formwork





## Technical data

Modular/GE		
Max. concrete pressure	Modular	35 kN/m <sup>2</sup> according DIN 18218
	GE	60 kN/m <sup>2</sup> according DIN 18218
Tolerances of deflection		According DIN 18202, table 3, line 7
Panel heights	Modular	62,5/75/100/125/150 cm
	GE	250/275 cm
	Extension panels GE	125/150 cm
Frame depth of Modular Formwork		7,5 cm; 15 m <sup>3</sup> volume for 200 m <sup>2</sup> with accessories
Modular panel construction		Steel frame of rigid, high quality flat steel
Plywood		15 mm thick, 11-ply Finnish birch plywood
Tie rod		DW 15, save working load 90 kN (not weldable)
	GE	4 ties on 200x250 cm, 200x275 cm panels
Panel widths	Modular	100/75/60/50/45/43/40/37/35/33/30/25/24/20/15/12/10/6/5 cm
	GE	150/200 cm
Plastic filler piece		Widths 1/2/3/4 cm · Heights 62,5/75/125/150 cm
Inside corner post		Leg length 13/15 cm
Dismantling inside corner post		Leg length 25 cm
Hinged corner post		Leg length 9,5 cm
Rigid corner 135 degrees	Inside	Width 12,5x12,5 cm · Heights 62,5/75/125/150 cm
	Outside	Width 25x25 cm · Heights 62,5/75/125/150 cm
Filler plate		Adjustments for 3/5/7 cm · Heights 62,5/75/125/150 cm
Keybolt	Connecting piece	Modular/GE panels
5-pin keybolt	Connecting piece	Plastic filler pieces, filler plate
Combi clamp	Connecting piece	Modular/GE-LOGO; Modular/GE-TTR
Panel clamp GE	Connecting piece	GE panels
Panel clamp GE adjustable	Connecting piece	Variable up to compensation of 5 cm
Panel clamp	Connecting piece	Combination of vertically and horizontally placed panels
Platform bracket		Walking width 90 cm
		3 kN/m <sup>2</sup> permissible load with bracket distance of 2,00 m
Crane lifting clamp		For crane transportation of formwork up to 24 m <sup>2</sup>
		Max. safe working load 600 kg
Spacer strap		Stop end
		Tensioning on top
		Wall thickness 6-50 cm/50-120 cm
Tie rod guide		Reduction of ties in the concrete
Bracing channel		Walers, lengths 35/85 cm
Waler guide 100		Fixing of walers
Waler guide 240		
Waling clamp		Fixing of squared timbers and timber girders
		Clamp range 8-20 cm
Fixing bracket		Fixing of 21/27 mm plywood
Connecting bow		Height extension with 21 mm plywood up to 30 cm
Polygonal formwork		
Polygonal filler post	Inside	Width 4,66 cm · Heights 62,5/75/125/150 cm
Polygonal filler post	Outside	Width 9,02 cm · Heights 62,5/75/125/150 cm
Foundation formwork		
Lengths of foundation straps		15/20/25/30/35/40/45/50 cm (other lengths on request)
Modular foundation tie clamp		Perforated foundation tie 50x2, roll at 25 m perforation 20/22 each 5 cm

Fast, reliable formwork system instead of conventional methods: PASCHAL systems make a decisive contribution in this vital step towards cost reduction in concrete construction. The following pages about Modular/GE Universal Formwork are an impressive indication of how one single formwork system can be put to universal use.

## Versatility

The Modular/GE Universal Formwork has really earned its name, because this system is used all over the world on many different building sites where it demonstrates its versatility, adaptability and flexibility, for foundations, walls, shafts, round walls, columns or beams.

The degree of difficulty of the structures to be build can vary considerably, because the balanced range of panels means that the formwork can be adjusted ideally to all layouts and cross sections. The size of the structures to be build does not matter: small surfaces are not a problem for the Modular panels.

And as far as large sizes are concerned, pre-assembled Modular panels can stay together as units or are supplemented by larger GE panels, with unlimited compatibility.

Your advantages:

- Only one investment
- Only one system on the building site
- The same parts are always used for different applications
- The formwork staff is used to working with the system
- Suitable for small surfaces, and can also be extended to become a large-size formwork



German factory, Nashik, Maharashtra, India



Aurobindo Galaxy Towers, IND-Hyderabad; Aurobindo realty & Infrastructure Pvt., India



Car dealership, KAZ-Karaganda; KKK Ltd., KAZ-Karaganda





Modular panel 100x125 cm



GE panel 200x275 cm

## The panels

The steel frame of the Modular/GE panels consists of 6 mm thick massive flat steel with an inlay of 15 mm thick 11-ply phenol resin-coated Finnish birch plywood.

The maximum concrete pressure for the Modular panels is 35 kN/m<sup>2</sup> according to DIN 18218 in full compliance with the tolerances of deflection according to DIN 18202, table 3, line 6.

For GE panels, the maximum concrete pressure is 60 kN/m<sup>2</sup>, but here line 7 applies.

The basic Modular Formwork panel measures 100 x 125 cm and weighs 49,5 kg.

GE panels are 200 (150) cm wide and 250 (275) cm high.

This means:

- Long service life
- Easy to repair
- High frequency of use
- Low panel weight
- Both handset formwork and large-size formwork

For other dimensions and accessory parts, please consult the parts list at the end of this chapter.

①

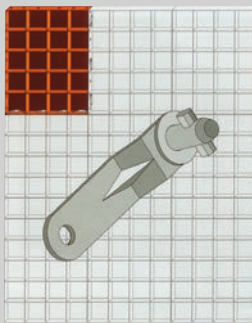

②

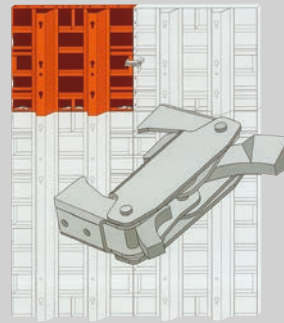

## GE panels

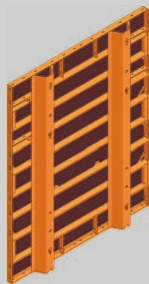

### GE panel

N116.502.2000	200 x 275 cm	280,00 kg
N116.502.1500	150 x 275 cm	243,00 kg
N115.502.2000	200 x 250 cm	258,00 kg
N115.502.1500	150 x 250 cm	217,00 kg

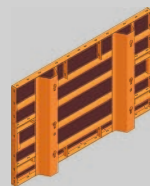

### Extension panel GE

N114.502.2000	200 x 150 cm	165,00 kg
N114.502.1500	150 x 150 cm	139,00 kg
N113.502.2000	200 x 125 cm	140,00 kg
N113.502.1500	150 x 125 cm	117,00 kg

## Panels and panel connections

The keybolt ① is the connecting piece for tight, flush and aligned joint connections. Alternatively, GE panels can also be joined together using the panel clamp GE ②.

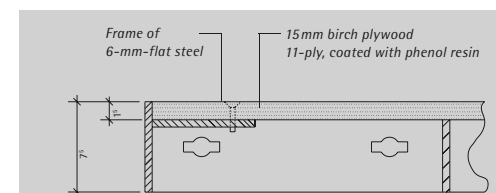

## Foundations

3

The Modular system can be adjusted to any layout and every height. The foundation strap is a practical and low-priced alternative as formwork anchor for this application. It is easy to install, requires no additional connection pieces to the formwork panels and still reliably takes up all the forces. In addition, as lost anchor it saves additional working space and expensive excavation.

If a crane is not available when the foundations are formed, the light weight of the Modular panels means that they can easily be moved by hand.

This means:

- An economic formwork system is already used in the early foundation stages
- Cost reductions compared to conventional formwork
- A crane is not necessary
- Foundation straps save additional working space and therefore excavation



New construction of an office building with warehouse, D-Gelnhausen; Grauel Hoch- u. Tiefbau GmbH & Co. KG, D-Birstein

### Fundamentspanner N/R

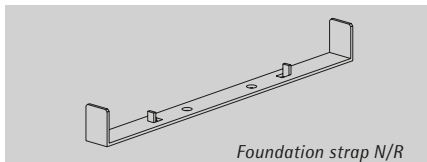

Foundation strap N/R

Pouring height	Foundation strap s
50 cm	100 cm
75 cm	75 cm
100 cm	50 cm
125 cm	25 cm

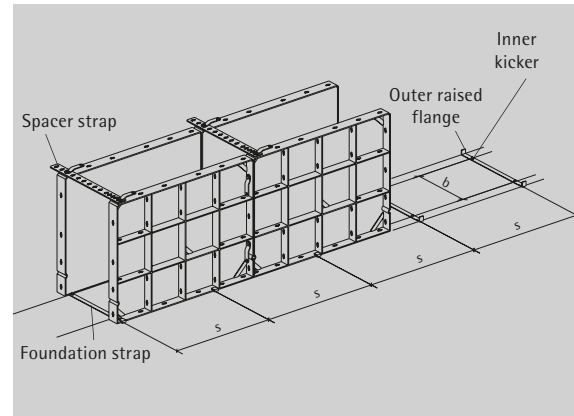

### Modular foundation tie clamp

- Delivered as roll the perforated tie can be cut at any foundation width.
- Simple installation with the Modular Universal Formwork. The Modular foundation tie clamp will be attached to every panel joint without any additional parts.
- Less work space necessary in comparison to assembly with tie rods. Reduced earthwork operations with less excavations and fill-ups.
- With the use of the foundation tie clamp below the formwork there is no collision with existing reinforcement or other already mounted parts.
- Crossing installation is also possible with block foundations.



max. concrete height	max. distance between perforated tie
75 cm	150 cm
100 cm	125 cm
125 cm	100 cm

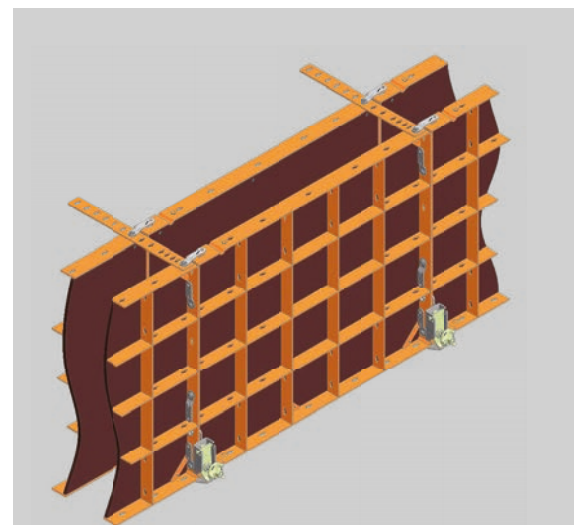

mount the perforated ties at every panel joint  
adm. load: 10 kN



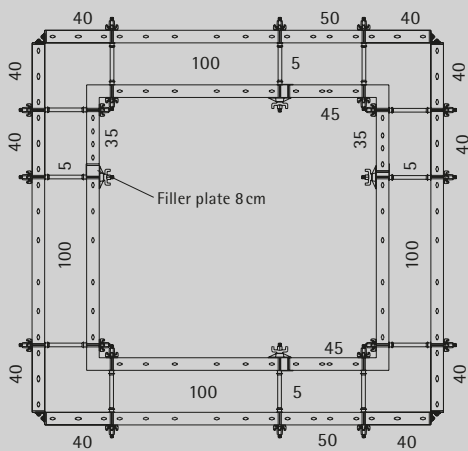

Well pad for refinery, Barmer, Rajasthan, India

## Shafts

Shafts can have different sizes, shapes and functions. All these structures make tough demands on formwork when it comes to the system's ability to adjust to extremely confined space. Here in particular the Modular Formwork system demonstrates its advantages with the well balanced range of panels which can be adjusted to every dimension, every angle and every corner.

The confined space conditions frequently make formwork dismantling extremely difficult, because the inside formwork is under tension. But PASCHAL has devoted some time and thought to this aspect too, and introduced the 8 cm filler plate as a possibility of dismantling the formwork without any squeezing. Filler plates and 5-pin keybolts provide a dismantling scope of 3, 5 or 7 cm, with the 5-pin keybolts connecting all panels with compression and tension strength. Modular Formwork used in shaft construction means:

- The system can be adjusted to the most confined space
- The system includes dismantling possibilities
- Even small panel widths and low panel heights are available
- Fixing brackets for pipe lead-throughs



*Where such underground shafts are concerned, the Modular Formwork can really demonstrate all its advantages. It makes the unavoidable job build filling used in other systems simply dispensable. You can form the entire shaft centimetre-by-centimetre with a time-saving system.*

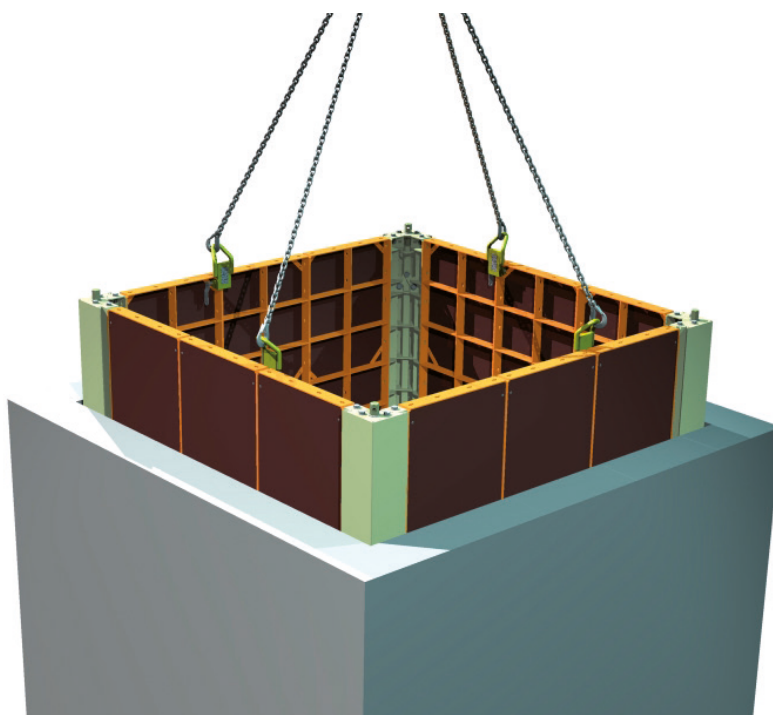

## Modular dismantling inside corner post

The movable dismantling inside corner post greatly reduces time required to form and dismantle the inner formwork for lift shafts, stairway cores and structures with tight spaces.

There is a hexagonal nut at the upper side of the inside corner post which will be turned to dismantle (clockwise) for dismantling and anticlockwise for pushing in right position before concreting. A spanner size 36 or a tie rod DW15 put in the hole of the hexagonal nut will be sufficient for turning.

- Optimized dismantling procedure
- Complete inner formwork can be moved as a whole unit
- Enormous gain of time



## Housing projects

No matter whether the cellar is being concreted for a single-family home or several storeys of a residential complex reaching up to the sky: Modular/GE Formwork can be used as a system for forming all the walls, shafts or columns in all different building sizes. Modular/GE Formwork can cope with all difficulties.

The important thing for you in all these projects:

- Use as wall formwork
- GE panels supplement the Modular Formwork for large sizes
- Same accessories for Modular and GE panels
- Complicated layouts are formed using this system without any on site production of fillers or specific parts.



Premium residential complex Abhra, IND-Hyderabad; My Home Constructions Pvt. Ltd.



Residential complex with 2,400 apartments, IND-Hyderabad; M/S. Tata Projects Limited



Social housing, DZ-Ouled Heddadj; EPE. EBA. SPA, DZ-Algiers



## Industrial construction and civil engineering

The compatibility of Modular and GE panels is particularly significant when it comes to complicated industrial and engineering construction projects. Depending on the task in hand, large-size GE panels and small-size Modular panels can be mixed and combined with each other without any restrictions.

Different wall cross sections with fitted consoles, canals or tapers can be formed practically without exception using this system. Together with the wide range of panel widths and heights, one particular advantage for complicated forming tasks such as these is the short leg length of the inside corner post (13 or 15 cm).



Aluminium factory, Singrouli, Madhya Pradesh, India



Box-Culverts, OM-Suhar; Fa. NCC Limited, IN-Hyderabad



Bridge, Sita-Rama irrigation project; HES Infra Pvt. Ltd., India



## Round solutions

Modular Formwork panels can also be used to form circular walls as polygons. For this purpose, polygonal filler posts are used at every panel joint. The size of the diameter being formed stipulates the required panel width:

**Large diameter – large panel width**

**Small diameter – small panel width**

All panel widths and accessory parts (connecting pieces, platform brackets, supports etc.) can be used for this formwork method. Apart from the filler posts no special parts are necessary. In addition to circular arcs, it is also possible to form all other curved shapes, such as ellipses and similar.

- Alternative solution at low material price compared to circular formwork systems
- All parts of the Modular Formwork can be used, no additional parts necessary
- All radii are possible
- Even egg shapes, ellipses, clothoids etc. are possible
- Many different possible applications



Planetarium, D-Halle; Leinetaler Hochbau GmbH, D-Wallhausen



Hydroelectric power plant, Baitarani Power Hydel Projekt, India



Overhead water tank, Ambattur- Chennai, Tamil Nadu, India

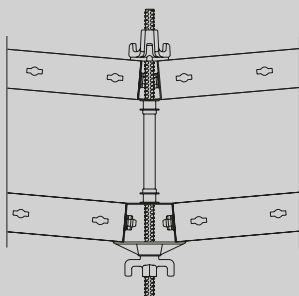
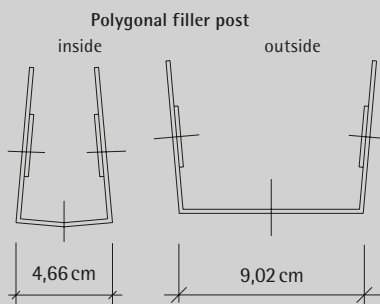





Medical faculty Algiers, DZ-Algiers ; Fa. Entreprise COSIDER-Construction, DZ-Dar El Beida, Algiers



Warehouse and office building, Karlsruhe; Dyckerhoff & Widmann AG; Karlsruhe

## Beams

Even horizontal structures such as beams can be formed without any problems using the Modular Formwork system. Regardless of whether these are clamped in one axis, crossing or fan-shaped, here once again all layouts can be formed using the Modular system without time-consuming job building. In these applications too, all parts, whether standing or lying, are connected with the keybolt for a positive connection coupling. This has the unique advantage that a complete formwork can be pre-assembled on the ground and then moved into position as a large-size unit using the crane.

- Pre-concreting beams
- Placing pre-fabricated or partially pre-fabricated slab on beam formwork
- Placing the plywood of a slab to be concreted also on beam formwork

This means:

- Ideal adjustment of the formwork to every cross section and layout by making full use of the system components
- Large-size pre-assembly possible
- No additional clamps
- No need to cut the plywood to size or dispose of leftovers

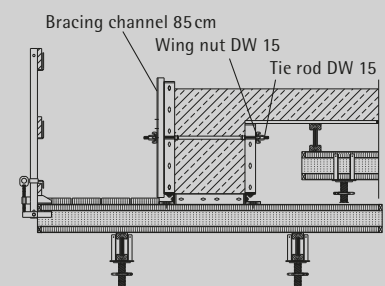

Edgebeam with slab



## Columns

3

Modular Formwork can also be used to put together a column formwork with just a few components:  
Just four parts:

- Panel
- Outside corner post
- Keybolt
- PVC chamfer angle

open up all possibilities of forming square, rectangular or angled columns. For oval columns, a connection panel can be used to connect half circles from the circular column formwork range. The individual parts can be connected simply using the keybolt.

This means:

- Every column cross section can be formed without needing special parts
- PVC chamfer angle for neat edge break (re-usable)
- All parts of the Modular Formwork system can be used, no additional parts required





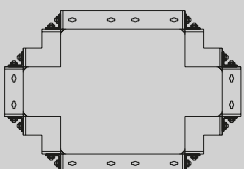
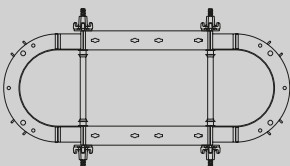
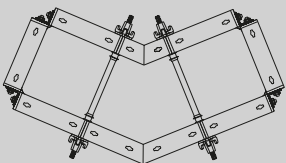
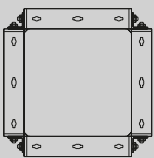













German factory, Nashik, Maharashtra, India



Max Planck Institute, D-Berlin; Berger Baugesellschaft mbH, D-Beelitz



## Parts list

Art.-No.	Description	kg	Art.-No.	Description	kg
					
<b>Modular panel</b>			<b>Modular dismantling inside corner</b>		
N104.001.1000	100 x 150 cm	59,00	N104.005.0251	25 x 25 x 150 cm	72,00
N104.001.0750	75 x 150 cm	44,50			
N104.001.0600	60 x 150 cm	35,40	<b>Plastic filler piece for Modular</b>		
N104.001.0500	50 x 150 cm	31,40	N104.011.1010	1 x 150 cm	1,00
N104.001.0450	45 x 150 cm	25,80	N104.011.1020	2 x 150 cm	2,00
N104.001.0400	40 x 150 cm	23,80	N104.011.1030	3 x 150 cm	3,00
N104.001.0350	35 x 150 cm	22,10	N104.011.1040	4 x 150 cm	4,00
N104.001.0300	30 x 150 cm	20,40			
N104.001.0250	25 x 150 cm	18,70	<b>Filler plate (for widths of 3/5/7 cm)</b>		
N104.001.0200	20 x 150 cm	16,90	N104.012.0005	8 x 150 cm	7,80
N104.001.0150	15 x 150 cm	15,20			
N104.001.0100	10 x 150 cm	13,40	<b>Modular panel</b>		
			N103.001.1000	100 x 125 cm	49,50
<b>Filler post</b>			N103.001.0750	75 x 125 cm	37,50
N104.003.0060	6 x 150 cm	11,60	N103.001.0600	60 x 125 cm	29,30
N104.003.0050	5 x 150 cm	11,00	N103.001.0500	50 x 125 cm	26,30
			N103.001.0450	45 x 125 cm	21,60
<b>Inside corner post</b>			N103.001.0430	43 x 125 cm	21,00
N104.005.0150	15 x 15 x 150 cm	20,70	N103.001.0400	40 x 125 cm	20,10
N104.005.0130	13 x 13 x 150 cm	19,30	N103.001.0370	37 x 125 cm	19,20
			N103.001.0350	35 x 125 cm	18,60
<b>Outside corner post</b>			N103.001.0330	33 x 125 cm	18,00
N104.006.0000	150 cm	7,60	N103.001.0300	30 x 125 cm	17,10
			N103.001.0250	25 x 125 cm	15,60
<b>Hinged corner post</b>			N103.001.0240	24 x 125 cm	15,30
N104.007.0001	9,5 x 9,5 x 150 cm	21,20	N103.001.0200	20 x 125 cm	14,10
N104.007.0002	without holes for ties	21,20	N103.001.0150	15 x 125 cm	12,60
			N103.001.0120	12 x 125 cm	11,70
<b>Hinged corner post with holes for ties</b>			N103.001.0100	10 x 125 cm	11,10
					
<b>Outside corner 135°</b>			<b>Filler post</b>		
N104.017.0001	25 x 25 x 150 cm	38,90	N103.003.0060	6 x 125 cm	9,10
			N103.003.0050	5 x 125 cm	8,60
<b>Modular dismantling inside corner</b>					
			<b>Inside corner post</b>		
<b>Outside corner post</b>			N103.005.0150	15 x 15 x 125 cm	17,80
<b>125 cm</b>					
<b>125 cm</b>			<b>Outside corner post</b>		
<b>125 cm</b>			N103.006.0000	125 cm	6,40
<b>125 cm</b>			<b>125 cm</b>		

Subject to technical changes

### Parts list

3







Art.-No.	Description	kg
N103.007.0001	Hinged corner post 9,5x9,5x125 cm without holes for ties	17,70
N103.007.0002	with holes for ties	17,70
N103.017.0002	Inside corner 135° 12,5x12,5x125 cm	20,20
N103.017.0001	Outside corner 135° 25x25x125 cm	32,60
N103.005.0251	Modular dismantling inside corner 25x25x125 cm	58,00
N103.011.1010	Plastic filler piece for Modular 1 x 125 cm	0,85
N103.011.1020	2 x 125 cm	1,70
N103.011.1030	3 x 125 cm	2,55
N103.011.1040	4 x 125 cm	3,45
N103.012.0005	Filler plate (for widths 3/5/7 cm) 8 x 125 cm	6,50
N102.001.1000	Modular panel 100 x 100 cm	40,40
N102.001.0750	75 x 100 cm	31,10
N102.001.0600	60 x 100 cm	24,50
N102.001.0500	50 x 100 cm	21,80
N102.001.0450	45 x 100 cm	17,90
N102.001.0400	40 x 100 cm	16,60
N102.001.0350	35 x 100 cm	15,20
N102.001.0330	33 x 100 cm	14,70
N102.001.0300	30 x 100 cm	13,90
N102.001.0250	25 x 100 cm	12,60
N102.001.0200	20 x 100 cm	11,20
N102.001.0150	15 x 100 cm	9,90
N102.001.0100	10 x 100 cm	8,60

Art.-No.	Description	kg
N102.003.0060	Filler post 6 x 100 cm	7,50
N102.003.0050	5 x 100 cm	7,10
N102.005.0150	Inside corner post 15 x 15 x 100 cm	13,70
N102.005.0130	13 x 13 x 100 cm	12,90
N102.006.0000	Outside corner post 100 cm	5,10
N102.007.0001	Hinged corner post 9,5x9,5x75 cm without holes for ties	14,20
N102.007.0002	with holes for ties	14,20
N102.017.0002	Inside corner 135° 12,5x12,5x100 cm	16,00
N102.017.0001	Outside corner 135° 25x25x100 cm	26,50
N102.011.1010	Plastic filler piece for Modular 1 x 100 cm	0,68
N102.011.1020	2 x 100 cm	1,36
N102.011.1030	3 x 100 cm	2,04
N102.011.1040	4 x 100 cm	2,72
N102.012.0005	Filler plate (for widths of 3/5/7 cm) 8 x 100 cm	5,20
N101.001.1000	Modular panel 100x75 cm	30,00
N101.001.0750	75x75 cm	24,10
N101.001.0600	60x75 cm	19,10
N101.001.0500	50x75 cm	16,80
N101.001.0450	45x75 cm	14,10
N101.001.0430	43x75 cm	13,70
N101.001.0400	40x75 cm	13,10
N101.001.0370	37x75 cm	12,50
N101.001.0350	35x75 cm	12,10
N101.001.0330	33x75 cm	11,70
N101.001.0300	30x75 cm	11,10

Subject to technical changes



## Parts list

	Art.-No.	Description	kg		Art.-No.	Description	kg	
	N101.001.0250	25x75 cm	10,10			<b>Modular panel</b>		
	N101.001.0240	24x75 cm	9,90		N100.001.1000		100x62,5 cm	27,50
	N101.001.0200	20x75 cm	9,10		N100.001.0750		75x62,5 cm	21,50
	N101.001.0150	15x75 cm	8,10		N100.001.0600		60x62,5 cm	16,90
	N101.001.0120	12x75 cm	7,50		N100.001.0500		50x62,5 cm	14,90
	N101.001.0100	10x75 cm	7,10		N100.001.0450		45x62,5 cm	12,30
					N100.001.0400		40x62,5 cm	11,30
	N101.003.0060	<b>Filler post</b> 6x75 cm	5,80		N100.001.0350	35x62,5 cm	10,50	
	N101.003.0050	5x75 cm	5,40		N100.001.0300	30x62,5 cm	9,60	
	N101.005.0150	<b>Inside corner post</b> 15x15x75 cm	10,50		N100.001.0250	25x62,5 cm	8,80	
					N100.001.0200	20x62,5 cm	8,00	
	N101.006.0000	<b>Outside corner post</b> 75 cm	3,80		N100.001.0150	15x62,5 cm	7,10	
					N100.001.0100	10x62,5 cm	6,30	
	N101.007.0001	<b>Hinged corner post</b> 9,5x9,5x75 cm without holes for ties	10,60		N100.003.0060	<b>Filler post</b> 6x62,5 cm	5,00	
	N101.007.0002	with holes for ties	10,60		N100.003.0050	5x62,5 cm	4,70	
					N100.005.0150	<b>Inside corner post</b> 15x15x62,5 cm	8,70	
					N100.006.0000	<b>Outside corner post</b> 62,5 cm	3,20	
	N101.005.0251	<b>Modular dismantling</b> <b>inside corner</b> 25x25x75 cm	42,00		N100.007.0001	<b>Hinged corner post</b> 9,5x9,5x62,5 cm without holes for ties	8,90	
					N100.007.0002	with holes for ties	8,90	
	N101.011.1010	<b>Plastic filler piece</b> for Modular 1x75 cm	0,50		N100.011.1010	<b>Plastic filler piece</b> for Modular 1x62,5 cm	0,43	
	N101.011.1020	2x75 cm	1,00		N100.011.1020	2x62,5 cm	0,85	
	N101.011.1030	3x75 cm	1,50		N100.011.1030	3x62,5 cm	1,28	
	N101.011.1040	4x75 cm	2,00		N100.011.1040	4x62,5 cm	1,70	
	N101.012.0005	<b>Filler plate</b> (for widths 3/5/7 cm) 8x75 cm	3,90		N100.012.0005	<b>Filler plate</b> (for widths 3/5/7 cm) 8x62,5 cm	3,25	

Subject to technical changes

### Parts list

3



















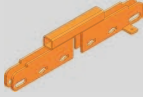

Art.-No.	Description	kg
N181.000.0024	GE/TTS panel clamp adjustable 0-5 cm	2,85
N181.000.0027	GE/TTS panel clamp	3,90
N181.000.0004	Suspending piece GE for props and walers	4,30
N181.000.0043	Combination waler 190 cm	34,00
N181.000.0044	Waler strap GE cpl.	3,50
N189.001.0031	Waler guide 100 clamping length 10cm N/R	0,50
N189.001.0032	Waler guide 240 clamping length 24cm N/R	0,70
N181.000.0028	GE Crane lifting clamp KBGE capacity 1.200 kg	6,50
N189.002.0008	Crane lifting clamp KA capacity 600 kg	4,00
N181.000.0020	GE Crane lifting clamp KGSL horizontal position admissible capacity 600 kg	4,00
N181.000.0049	Stop end guide GE cpl.	3,10
N189.001.0100	Keybolt	0,19

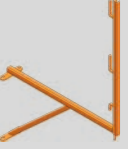
Art.-No.	Description	kg
N189.001.0105	5-pin keybolt	0,30
N189.001.0079	Panel clamp N/R	0,85
Tie rod		
N189.006.0650	DW 15x 65 cm	0,90
N189.006.1000	DW 15x 100 cm	1,40
N189.006.1350	DW 15x 135 cm	1,85
N189.006.1500	DW 15x 150 cm	2,10
Welding is not possible.		
N189.001.0001	Wing nut DW15	0,46
N189.001.0002	Hexagon nut DW15	0,20
N189.001.0059	Plate with ball-and-socket joint DW 15 10x14cm inclin. max. 12°	1,29
N189.001.0060	Counter plate 12x 12 x 1,5 cm ø 21 mm	1,60
Spacer strap		
N189.001.0020	6-50 cm N/TR/R	1,50
N189.001.0021	50-120 cm N/TR/R	3,50
N189.001.0086	Tie rod guide N/R	0,75
N189.001.0071	Bracing channel support bracket	0,60
Bracing channel		
N189.001.0066	35 cm	1,50
N189.001.0067	85 cm	4,00
Waling clamp with wedge cpl. consisting of:		
N670.000.0013	Waling clamp	2,00
N670.000.0014	Clamping piece	0,55
N189.001.0000	Wedge	0,16

Subject to technical changes

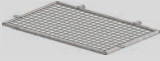

### Parts list

	Art.-No.	Description	kg		Art.-No.	Description	kg
	N189.001.0017	Fixing bracket for 21 mm plywood	0,45		N940.100.0000	Perforated foundation tie 50x2, roll at 25 m perforation 20/22 each 5 cm	15,70
	N189.001.0018	for 27 mm plywood	0,45			N189.000.0010	Support Modular cpl. lateral protection Secuset
	N189.003.0000	Assembly tool N/TR/R	3,90			N189.000.0020	Support GE cpl. lateral protection Secuset
		N180.000.0012	Transportation angle for 12 panels		4,70		N189.000.1001
N280.000.0042		for 20 panels	8,00		N189.000.1010		Support for toe board lateral protection Secuset
	N180.000.0025	Suspending piece for props cpl. N/R	2,65			N189.000.1011	Support for protection fence Secuset
		N189.001.0084	Connecting bow for 21 mm plywood	2,45			N189.000.0011
N189.001.0085		for 27 mm plywood	2,45		N189.004.0013		Platform bracket cpl. 90 cm
	N100.014.0001	Polygonal filler post inside 4,66x62,5 cm	2,90			N189.000.1035	Lateral protection fence 230x80cm Secuset
	N101.014.0001	4,66x75 cm	3,40			N189.000.1036	Lateral protection fence 130x80cm Secuset
	N102.014.0001	4,66x100 cm	5,00			N189.002.0003	Transportation box hot-dip galvanized 1200x800x610 mm
	N103.014.0001	4,66x125 cm	5,80			N940.009.0019	Cover lattice box/ transportation box 1100 x 680 x 35 mm
	N104.014.0001	4,66x150 cm	6,90				
	N100.014.0002	Polygonal filler post outside 9,02x62,5 cm	3,20				
	N101.014.0002	9,02x75 cm	3,90				
	N102.014.0002	9,02x100 cm	5,70				
	N103.014.0002	9,02x125 cm	6,50				
	N104.014.0002	9,02x150 cm	7,80				
	Foundation strap N/R						
	N180.001.0200	20 cm	0,28				
	N180.001.0250	25 cm	0,31				
	N180.001.0300	30 cm	0,34				
	N180.001.0350	35 cm	0,38				
	N180.001.0400	40 cm	0,41				
	N180.001.0450	45 cm	0,44				
	N180.001.0500	50 cm	0,48				
N180.001.0600	60 cm	0,54					
	Additional sizes on request						
	N180.000.0000	Modular foundation tie clamp	2,60				

Subject to technical changes

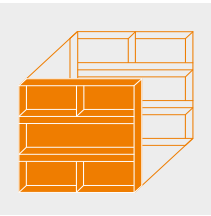

# Neor

Lightweight formwork





## Less weight - more performance

The NeoR is the perfect mix of lightness (only 30kg/m<sup>2</sup>) and stability (up to 50kN/m<sup>2</sup>). Given the wide range of possible applications (standing, lying, combined standing and lying), it is extremely adaptable and replaces many different panel assortments.

### Technical Data

NeoR	
Panel widths	90/75/60/45/30/15 cm
Panel heights	150/90 cm
Large-size panel	180x300 cm
Frame depth	7,5 cm
Plywood	12 mm finnish birch plywood (9-ply)
Max. concrete pressure	50 kN/m <sup>2</sup> according DIN 18218
Tolerances of deflection	According DIN 18202, table 3, line 6
Formwork anchor	Tie rods DW15
Frame	flat steel with a thickness of 6 mm

## NeoR Lightweight formwork

4

PASCHAL provides the ideal solution for every formwork task. Due to the low weight (30 kg/m<sup>2</sup>), the NeoR can be moved easily by hand – ideal for construction sites, even without a crane.

- Universal fields of application: Foundations, columns, beams, walls
- Height offset of the panels can be performed via oblong holes in the panel frame
- Well-balanced range of panels
- 90 x 150 cm panel can be used both vertically and horizontally due to internal tie-points
- A floor height of up to 3 m can be formed with just one extension
- Keybolts as lightweight, friction-locked and cost-effective connecting pieces
- Easy attachment of accessories using the hook head principle
- The structural height is just 7.5 cm → low storage and transport volume
- The flat steel frame guarantees robustness and durability
- Fresh concrete pressure capacity of 50 kN/m<sup>2</sup>
- Compatible with all PASCHAL systems



Functional bars for attaching accessories such as crane lifting clamps, fall protection, waler support, etc. and for easy transportation



Keybolts as connecting pieces

Existing accessory parts are compatible

Have you already seen it?



In our new application video we present all product highlights of the NeoR lightweight formwork. It's worth taking a look!



Multi waler

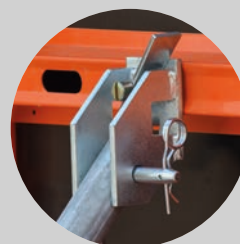

Suspending piece for props



Foundation tie clamp



Platform bracket

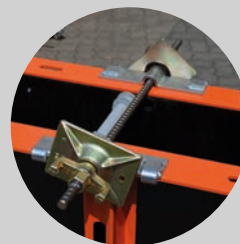

Tie rod guide

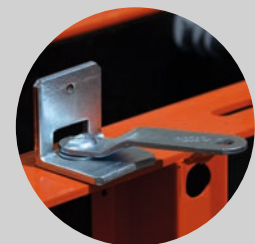

Fixing bracket



## Advantages

### OBLONG HOLES AND KEYBOLT HOLES

Height offset of the panels on uneven installation surfaces can be performed up to 2cm in a 15cm grid via oblong holes in the panel frame.



### LARGE-SIZE PANEL

With the large-size panel 180 x 300 cm even large areas can be implemented quickly and economically.

### INTEGRATED HANDLE

Thanks to the integrated handle and the light weight this formwork can be assembled and moved easily by hand.

### INTERNAL TIE-POINTS

The formwork can be used both vertically and horizontally. Therefore the panels 90 x 150cm and the large-size panel have additional internal tie-points.

### EXTERNAL TIE-POINTS

The external tie-points guarantee the lowest number of tie-points and thereby an optimal concrete appearance.

### KEYBOLTS

The keybolt serves as lightweight, frictionlocked and above all cost-effective connecting pieces.

### PASCHAL-PLYWOOD

The particularly resilient and already proven plywood consists of 9-layer, 12 mm thick finnish birch plywood.

### FUNCTIONAL BARS

Accessories such as suspending pieces for props or platform brackets can be attached at the functional bars.

### FLAT STEEL FRAME

The frame consists of flat steel with a thickness of 6 mm and is light, impact resistant, repairable and has a high durability.

### CROSS PROFILES

The cross profiles provide additional stability and provide more robustness and reduced deformability.

## Well-balanced range of panels & accessories

### Perfectly coordinated element sizes

4

- ideal utilisation of the formwork storage by a well-balanced range of panels
- universal fields of application: foundations, columns, beams, walls
- a floor height of up to 3 m can be formed with just one extension using the panel height 150 cm
- formwork widths of 15 cm up to 90 cm in a 15 cm grid
- all panels can be combined both vertically and horizontally with each other in the same construction project
- with 5, 6 and 10 filler posts for residual compensations and matching plastic filler pieces, everything can be formed down to the centimetre

Height 150 cm

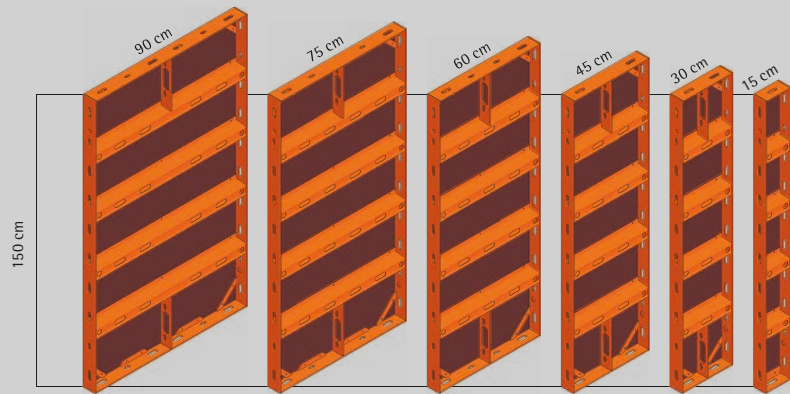

Height 90 cm

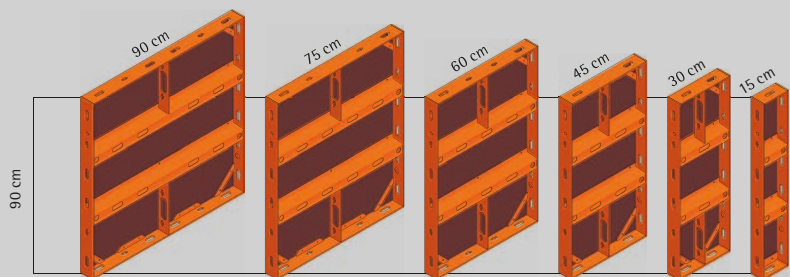

## Large-size panel

### 180 x 300 cm

- a floor height of up to 3 m can be formed without extension with the large-size panel or with just one extension with the 150 cm panel range
- large areas can be formed economically with the large-size panel 180 x 300 cm i.e. 5,4m<sup>2</sup>
- can be used both vertically and horizontally
- only 2 tie points on a height of 3m if it is tensioned on top

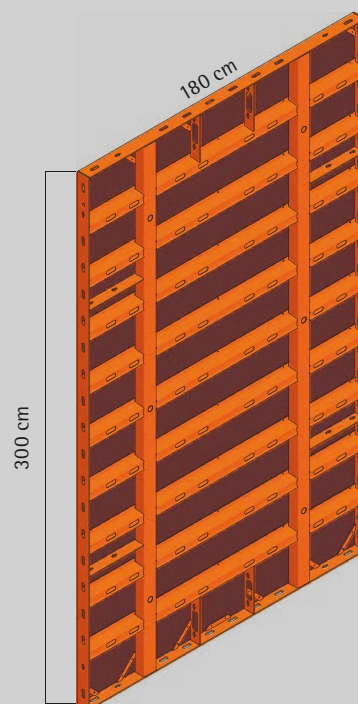



## Exposed concrete

The lightweight formwork ensures a perfect concrete appearance



- less joints with the large size panel
- fewer tie points ensure an optimal concrete appearance, therefore ideal for exposed concrete
- maximum concrete pressure of 50 kN/m<sup>2</sup> fulfills the tolerances of deflection according to DIN 18202, table 3, line 6

4



Configuration example – Universally and flexibly applicable

**Compatibility**  
Compatible with all  
PASCHAL systems

### Modular/GE formwork



- the same frame depth as the Modular/GE universal formwork
- panels are connected via a filler post with the keybolt
- common accessories can be reused

### LOGO formwork



- easy to combine with the combi clamp
- cross profiles for fixing of same accessories
- common accessories are compatible
- Height offset can be performed easily

### TTR formwork



- the same oblong holes as the Circular Trapezoidal girder formwork
- panels are connected via a filler post with the keybolt
- Seamless connection straight / round

## Application examples

4



Accessories and connecting pieces of the Modular/GE universal formwork and the wall formwork LOGO.3 can also be used for the lightweight formwork NeoR.



The lightweight formwork NeoR has been extensively tested and is ready for use in a wide variety of fields.













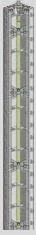



The integrated oblong holes in the element frame allow a height offset of up to 2 cm for uneven installation surfaces.



The NeoR is the perfect formwork for every construction project because of its high flexibility and the balanced sorting of panels.



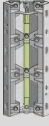



















Parts list

	Art.-No.	Description	kg		Art.-No.	Description	kg
	N167.001.1800	NeoR panel 180 x 300 cm	186,00		N164.005.0251	NeoR dismantling inside corner post 25 x 25 x 150 cm	71,10
	N167.005.0251	NeoR dismantling inside corner post 25 x 25 x 300 cm	135,80		N164.011.1010	Plastic filler 1 x 150 cm für NeoR	0,90
	N164.001.0900	NeoR panel 90 x 150 cm	41,30		N164.011.1020	2 x 150 cm für NeoR	1,80
	N164.001.0750	75 x 150 cm	36,40		N164.011.1030	3 x 150 cm für NeoR	2,70
	N164.001.0600	60 x 150 cm	30,90		N164.011.1040	4 x 150 cm für NeoR	3,60
	N164.001.0450	45 x 150 cm	25,90		N162.001.0900	NeoR panel 90 x 90 cm	26,90
	N164.001.0300	30 x 150 cm	21,00		N162.001.0750	75 x 90 cm	23,80
	N164.001.0150	15 x 150 cm	14,80		N162.001.0600	60 x 90 cm	20,00
	N164.003.0100	NeoR filler post 10 x 150 cm	13,60		N162.001.0450	45 x 90 cm	16,90
	N164.003.0060	6 x 150 cm	11,10		N162.001.0300	30 x 90 cm	13,70
	N164.003.0050	5 x 150 cm	10,50		N162.001.0150	15 x 90 cm	9,20
	N164.005.0150	NeoR inside corner post 15 x 15 x 150 cm	20,70		N162.003.0100	NeoR filler post 10 x 90 cm	8,50
	N164.006.0000	NeoR outside corner post 150 cm	7,50		N162.003.0060	6 x 90 cm	6,70
	N164.007.0001	NeoR hinged corner 9,5 x 9,5 x 150 cm w/o opening	20,90		N162.003.0050	5 x 90 cm	6,40
					N162.005.0150	NeoR inside corner post 15 x 15 x 90 cm	12,70
					N162.006.0000	NeoR outside corner post 90 cm	4,50
					N162.007.0001	NeoR hinged corner 9,5 x 9,5 x 90 cm w/o opening	12,50
					N162.005.0251	NeoR dismantling inside corner post 25 x 25 x 90 cm	46,30
					N162.011.1010	NeoR plastic filler 1 x 90 cm	0,60
					N162.011.1020	2 x 90 cm	1,20
					N162.011.1030	3 x 90 cm	1,80
					N162.011.1040	4 x 90 cm	2,40

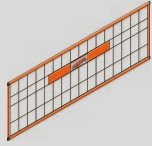
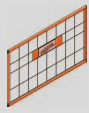
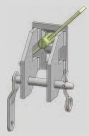
Subject to technical changes

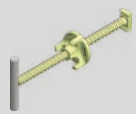
Parts list

	Art.-No.	Description	kg
	N189.001.0100	Keybolt	0,19
	N189.001.0105	5-pin keybolt	0,30
		<b>Tie rod</b>	
	N189.006.0650	DW15 x 65 cm	0,90
	N189.006.0850	DW15 x 85 cm	1,19
	N189.006.1000	DW15 x 100 cm	1,40
	N189.001.0059	Plate with ball-and-socket joint DW15 x 10 x 14 cm inclin. max.12°	1,29
		<b>Spacer strap</b>	
	N189.001.0020	6-50 cm N/TR/R	1,50
	N189.001.0021	50-120 cm N/TR/R	3,50
	N189.001.0086	Tie rod guide N/R	0,75
	N189.002.0008	Crane lifting clamp KA capacity 600kg	4,00
	N180.500.0004	NeoR Loading auxiliary	0,70
	N189.001.0017	Fixing bracket for 21mm plywood	0,45
	N189.001.0118	Double channel waler U 60 x 800 mm	8,20
	N189.001.0067	Bracing channel 85 cm	4,00
	N189.001.0071	Bracing channel support bracket	0,60
	N189.001.0079	Panel clamp N/R	0,85

	Art.-No.	Description	kg
	N189.000.0040	NeoR bracket Secuset	8,20
	N189.000.1001	Railing post 120 cm Secuset	3,20
	N189.000.1010	Support for toe board Secuset	0,46
	N189.000.0041	Support NeoR cpl. Secuset	2,90
	N189.000.1035	Lateral protection fence 230 x 80 cm Secuset	10,10
	N189.000.1036	Lateral protection fence 130 x 80 cm Secuset	6,60
	N187.500.0003	Suspending piece for props L/N/A cpl.	2,00
	N180.500.0002	Waling clamp NeoR 10-20 cm	1,20
	N180.500.0005	Support for walers clamping length 6-24 cm L/N/A	1,20
	N187.500.0164	Multi waler 140	16,80
	N187.500.0165	Clamping piece 10cm L/N/A	1,30
	N187.500.0168	Hinged part multi waler cpl. galvanized	5,00

Subject to technical changes



## Parts list

	Art.-No.	Description	kg
	N187.500.0162	Step L/N	4,70
	N287.500.0026	Combi clamp LOGO-N/TR/R	2,20
	N180.500.0001	NeoR transportation angle for 12 panels	5,60
	N189.002.0003	Transportation box hot-dip galvanized 1200 x 800 x 610 mm	86,50
	N940.009.0019	Cover lattice box/transportation box 1100 x 680 x 35 mm	6,70
	N189.003.0000	Assembly tool N/TR/R	3,90
	N182.000.0179	Centering tool N/TR/R	0,80
		<b>Foundation strap</b>	
	N180.001.0120	12cm N/R	0,23
	N180.001.0150	15cm N/R	0,24
	N180.001.0175	17,5cm N/R	0,26
	N180.001.0200	20cm N/R	0,28
	N180.001.0240	24cm N/R	0,30
	N180.001.0250	25cm N/R	0,31
	N180.001.0300	30cm N/R	0,34
	N180.001.0350	35cm N/R	0,38
	N180.001.0365	36,5cm N/R	0,39
	N180.001.0400	40cm N/R	0,41
	N180.001.0450	45cm N/R	0,44
	N180.001.0500	50cm N/R	0,48
	N180.001.0600	60cm N/R	0,54
	N180.001.0700	70cm N/R	0,61
	N180.001.0800	80cm N/R	0,67
	N180.001.0900	90cm N/R	0,74
	N180.001.1000	100cm N/R	0,81
	N187.500.0125	Foundation tie clamp for L/N	2,15
	N940.100.0000	Perforated foundation tie 50x2, roll at 25 m perforation 20/22 each 5 cm	15,70



Subject to technical changes

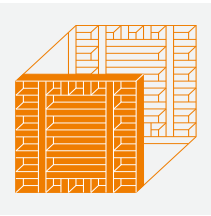

# LOGO.3

Wall formwork





## Technical data

LOGO.3		
Max. concrete pressure	LOGO.3	70 kN/m <sup>2</sup> as per DIN 18218
Tolerances of deflection		According to DIN 18202, table 3, line 6
Panel heights	LOGO.3	340/305/270/240/135/90 cm
Frame depth		12 cm
Frame	LOGO.3	Profiled flat steel frame of high-strength steel
Cross section	LOGO.3	Omega profile, suitable to take accessories
Plywood		16 mm thick, 12-ply Finnish birch plywood
Tie rod		DW 15, max. safe working load 90 kN (not weldable)
Large-size panels	LOGO.3	240x340/240x305/240x270 cm, can be used in vertical or horizontal position
Midi-panel		135x270 cm, can be used in vertical or horizontal position
Panel widths	LOGO.3	90/75/60/55/50/45/40/30/25/20 cm
Multi-purpose panel	LOGO.3	Outside corner panel, wall thickness 10 – 50 cm Variable column formwork 20 – 75 cm in steps of 5 cm
Plastic filler pieces		Widths 1/2/3/4/5/6 cm
Fixing post		Compensations with 21 mm plywood
Inside corner post		Leg length 25 cm
Dismantling inside corner post		Leg length 25 cm
Hinged corner post	Inside	Leg length 30 cm, adjustable from 60 – 180 degrees Fixing for 60/90/135 degrees
	Outside	Leg length 12,5 cm, adjustable from 60 – 180 degrees
Wedge clamp	Connecting piece	Panels, max. tension 7 kN
Combi clamp	Connecting piece	LOGO-Modular/GE; LOGO-NeoR; LOGO-TTR
Multi clamp	Connecting piece	Variable up to compensation of 10/20 cm
Locking screw	Connecting piece	Multi-purpose panels Plastic filler pieces up to 12 cm Steel filler pieces 5 and 6 cm Height extensions Stop ends Max. tension force in screw axis 22 kN Max. shear force 20 kN
Spacer channel		Stop end and tensioning on top Wall thickness 15 – 50 cm in steps of 5 cm (24/36,5 cm)
Multi waler 140	Height extensions	Max. height 8,10 m with pre-assembly in horizontal position 2 multi waler per large-size panel 1 multi waler per compensation panel Walers Compensations
Crane lifting clamp		Crane transport up to 30 m <sup>2</sup> formwork Logo.3 Max. safe working load 1200 kg
Loading auxiliary		For crane transport of bundled panels Maximum 1900 kg (4 loading auxiliaries)
Tie rod guide		Reduction of ties in the concrete
Platform bracket		Walking width 1 m Max. safe working load for 2 m bracket spacing 3 kN/m <sup>2</sup>
Suspending piece for props		For connecting supports to formwork
Support for walers DW15		Fixing of squared timbers, wooden girders, supporting jacks and steel walers to cross sections Clamp range 6 – 20 cm
Panel support		Fixing of formwork on climbing brackets
Adjustment unit		Vertical adjustment of formwork on climbing brackets

## Flexible wall formwork

PASCHAL LOGO.3 wall formwork is available in a comprehensive panel assortment, which allows it to be used flexibly, whatever the ground plan of your building. With large-size panels ranging from 2.40 metres in width right down to narrow, plastic filler pieces, this product reflects the principle practiced by PASCHAL of offering a system that comprises all types of formwork activity. This avoids the need for expensive additional site work and minimises construction times, whether a large-area formwork construction is required a smaller scale complex ground plan is to be followed.

With a maximum permissible poured concrete pressure level of 70 kN/m<sup>2</sup>, in line with DIN 18218, LOGO.3 fulfils the tolerances of deflection laid down by DIN 18202, table 3, line 6. The facing material is 15-mm-thick, 11-ply, phenolic resin coated Finnish birch plywood. This is worked directly into the formwork panels and includes omega profile for extra support. This results in a high quality concrete surface.

Have you already seen it?



In our application video we present all product highlights of the LOGO.3 wall formwork. It's worth taking a look!



Sports hall, D-Karlsruhe-Knielingen; Weisenburger Bau GmbH, D-Rastatt



Bridge construction Bartrup bypass; Fa. Bauunternehmung Wilhelm Becker GmbH & Co. KG



Santander Foals Campus of Borussia Mönchengladbach football team; Heinrich Temmink GmbH & Co. KG, D-Vreden





## Light and solid frame - Varied applications



Cellar in residential building, D-Ergolding; Lachermeier GmbH, D-Ergolding

The LOGO frame is made of extra-hard, 5-mm-thick flat-rolled steel, profiled for additional stability. This solid profile is more resistant to mechanical stress, for instance from hammer blows, than a hollow profile. On the other hand, should damage ever occur, something which cannot be avoided in everyday use on site, this type of profile also allows repairs to be carried out. This results in a considerable increase in the service life of formwork which is subjected to repeated use.

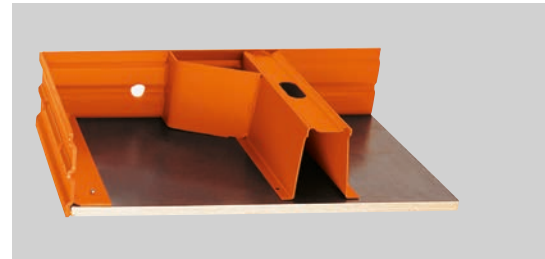

- Solid and robust
- Impact resistant
- Easy to repair
- Long service life



Underwater parking garage, DK-Kopenhagen; NCC, DK-Kopenhagen



Residential and administrative buildings, D-Münster; Averbek Bau GmbH & Co. KG, D-Ostbevern



## Large-size formwork panels - fairfaced concrete

5

The special characteristics of large-size panels display several advantages when using LOGO.3 formwork in large building sections, the first of which is a considerable reduction in the number of ties per square metre of wall area.

For example, the 240x270 cm panel only has four ties, which translates to a rate of 0,62 tie holes per square metre for a formwork area of 6,5m<sup>2</sup>. This minimises the cost of materials and labour for setting the required fixings and sealing the holes.

A further benefit is that only a small number of connectors (wedge clamps) are needed, since only few butt joints occur when using large-size panels, even over a large wall area.

All of these factors together result in excellent formwork times while fulfilling the stringent demands of the concrete surface, without necessitating any further measures.

- Few butt joints
- Few accessories needed
- Low number of tie holes
- Excellent formwork times
- Optimum concrete surface results



Building for production, D-Haslach; Fa. Singler Bau, D-Hofstetten



Residential complex, D-Munich; S. Pöttinger GmbH & Co. KG Bauunternehmung, D-Ottobrunn

Panel	Number of tie holes per m <sup>2</sup> of wall area
340x270 cm	0,65
240x270 cm	0,62
240x305 cm	0,55
240x340 cm	0,49



LOGO.3 midi-panel 340x135 cm



LOGO.3 large-size panel 340x270 cm



## Comprehensive range of panels



IMBIT research building, University Freiburg; Implenia AG



Water reservoir Surcuolm, CH-Obersaxen GR; Candrian SA, CH-Illanz

The comprehensive LOGO.3 panel assortment includes not only large-size panels but also small panel widths, in a 5-cm grid dimension, as well as steel filler pieces in widths of 5 cm and 6 cm. This allows to perform rapid formwork construction for all dimensions in this gradation, without the need for on-site solutions, even if only a certain selection of panel widths is available.

5

Example: 5-cm Grid	
45 cm + 50 cm	= 95 cm
50 cm + 50 cm	= 100 cm
50 cm + 50 cm + 5 cm	= 105 cm
50 cm + 55 cm	
55 cm + 50 cm + 5 cm	= 110 cm
55 cm + 55 cm	
Plus many more possible combinations.	

In addition to this, plastic filler pieces are available in widths between 1 cm and 4 cm, creating a system which allows for the construction of formwork in whatever dimensions are required.

- Rapid application, because system permits construction for all ground plan dimensions
- No additional on-site formwork required
- Considerable reduction in time spent on forming



## Panel height 340 cm

The panels have a height of 340 cm without joint and offer the additional advantage of allowing formwork to be created for large wall heights, without the need for additional extensions, for instance using two panels to achieve heights of up to 6,80 metres. This precludes the need for using a large number of small panels and accessory items, which in turn considerably reduces both labour costs and forming times. When used at a storey level of 3,40 metres, only two ties are necessary at panel level.



Technical college, D-Holzkirchen; Bauunternehmung Ehrenfels GmbH, D-Karlstadt



Warehouse, D-Kaiserslautern; Linnebacher Bau GmbH, D-Neunkirchen





LOGO.3 large-size panels 340x270cm

## Panel height 340 cm

All panel widths have a full-height (shafted) plywood to allow for the fulfilment of stringent exposed concrete requirements. Of course, even with this panel height, all types of accessories, including connectors, clamps, platform brackets, supports and rails can be used without restriction. Depending on the height of the concrete, horizontal applications are also possible.

5



New construction Haka-Gerodur, CH-Benken; Föllmi AG, CH-Pfäffikon



Water reservoir, FL-Balzers; Unternehmer Meisterbau AG, FL-Balzers



## Vertical/horizontal placement for an ordered joint structure

Different projects generally require different concrete heights. To remain flexible in the face of changing requirements, all LOGO.3 formwork panels can be used vertically or horizontally, singly or in combination. Underground garages, for example, often have relatively low walls. It is therefore possible to use a 240x270 cm large-size panel in a horizontal position, whereas it would be employed vertically for an apartment wall.

To achieve greater wall or formwork heights, it is possible to combine two or more panels in rows. All combinations can be used either vertically or horizontally.

- Optimum alignment to any wall height
- Minimum warehouse stock

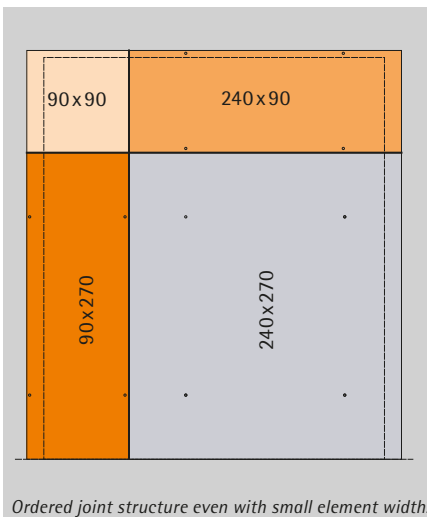
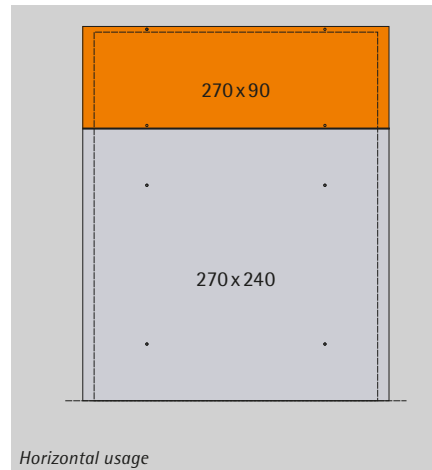
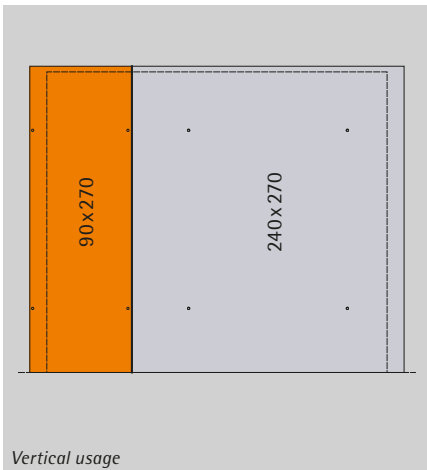



## Simple mounting of accessories



Continuous transverse profile



Platform brackets



Suspending piece for props

A complete formwork system includes not only the formwork panels, but also accessories, such as adjustable props (for redirecting and deflecting wind loads), platform brackets (for working safety) and combination rails (for alignment of larger formwork heights).

These parts must be mounted to the formwork panels in sufficient quantity. To this end, with Logo panels, all transverse profiles are fashioned to fix accessories (omega profiles), allowing fast and flexible assembly. With all assembly components, mounting is always according to the same principle, that of the T-head.

- ① Insert T-head
- ② Turn T-head
- ③ Lock

It makes no difference whether the panels are vertical or horizontal, since the insertion or twist direction can always be adjusted by 90°. The mounting principle is therefore always the same.

- Rapid mounting of accessory parts
- Flexible mounting of accessory parts
- Same mounting principle applies at all times

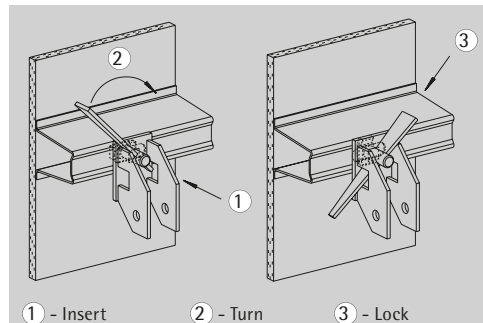

Multi-waler - The multi-waler is used here combined with LOGO clamping pieces (10 cm). Alternatively it is possible to also use the waler support or hook head, for example.

## Wedge clamps

The connector used for LOGO.3 is the wedge clamp, which is placed at the vertical and horizontal joints between panels. The special feature of this connector is the curved wedge, which can be hit frontally, where there is always sufficient space, both when closing and opening. This is particularly beneficial with storey-high formwork, especially with the lower and upper wedge clamps and around inside corner posts or hinged corner posts.

With a weight of only 1,80 kg, the wedge clamp is a lightweight among clamp connectors.

- Ergonomic in use
- Low weight
- Robust
- Quick assembly and disassembly



## Multi Clamp

With the Multi Clamp it is possible to add a filler piece in a joint between two LOGO.3 or LOGO.alu panels. The width of a joint can be varied steplessly between 0 and 20 cm.

On a joint of 2.70 m height three Multi Clamps placed on the omega profiles are necessary to tighten and perfectly align the formwork.

- Ergonomic design
- Adjusting range steplessly variable
- Robust
- Quick assembly and disassembly

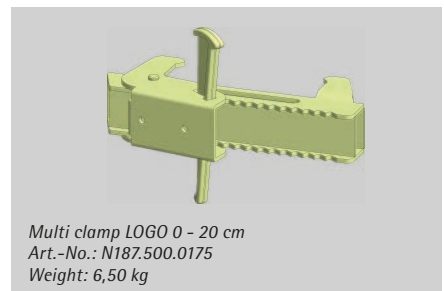
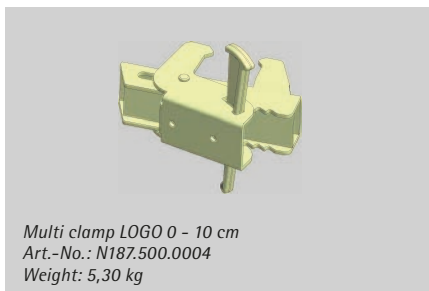
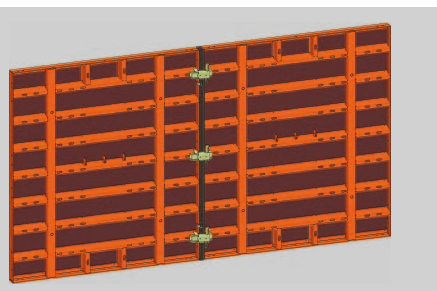
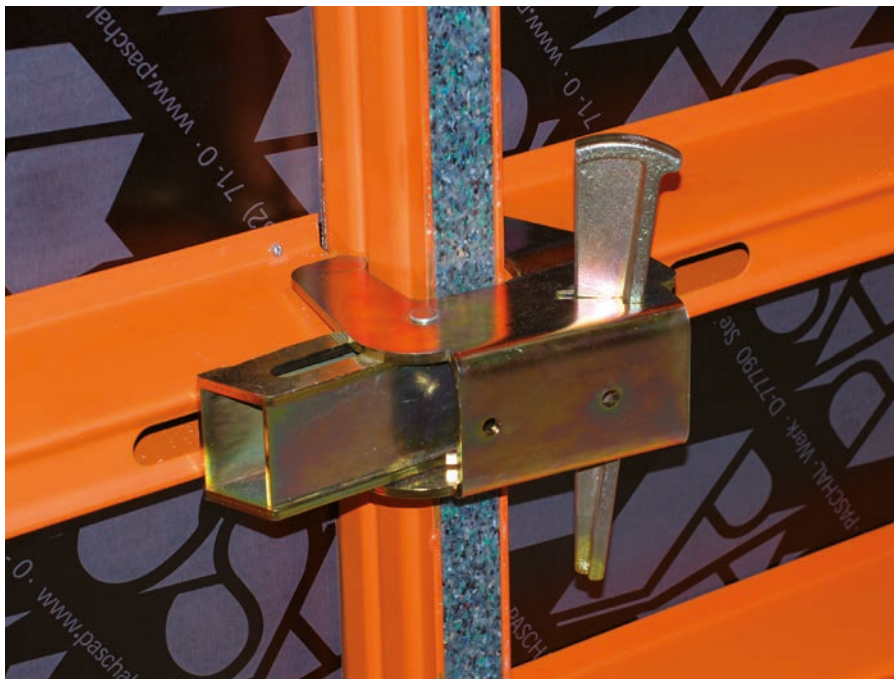



## Locking screw



As a universal connector, the locking screw fulfils a number of functions in a formwork system:

- ① To connect a compensation panel and a multi-purpose panel around a 90° corner
- ② To connect a multi-purpose panel with another multi-purpose panel around a column
- ③ To connect a spacer channel at a stop end
- ④ To connect a fixing post for balancing residual space
- ⑤ To connect two panels instead of using a wedge clamp
- ⑥ To connect two panels incl. fillers up to 12 cm instead of using a multi-clamp

5

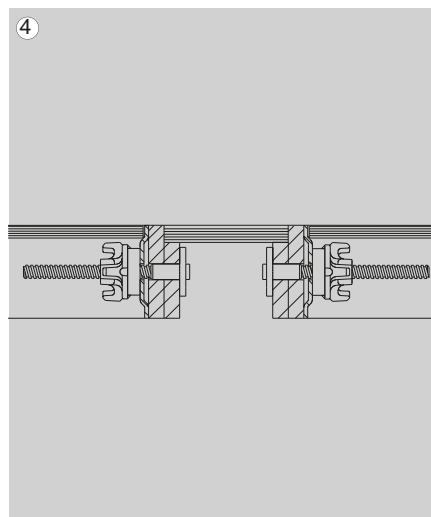

This simplifies the scheduling and handling of materials at the building site because it is always concerns the same part.

- Universal application
- Simple material management
- Alternative as place reducing connector (transport)



## Multi-purpose panel

The multi-purpose panel is the most flexible element within the LOGO system. Additional welded-in hole profiles mean that it can be used together with the locking screw for:

5

- ① 90° corners
- ② Columns
- ③ Stop ends

The bore holes in the hole profiles also allow the user to set ties (also internally), for:

- ④ Longitudinal joints
- ⑤ Transverse joints
- ⑥ Multi-purpose panels as wall panels

This results in a high efficiency of the material employed.

- Universal application
- Reduction in need to stock various panel widths
- High deployment rate
- Good forming times

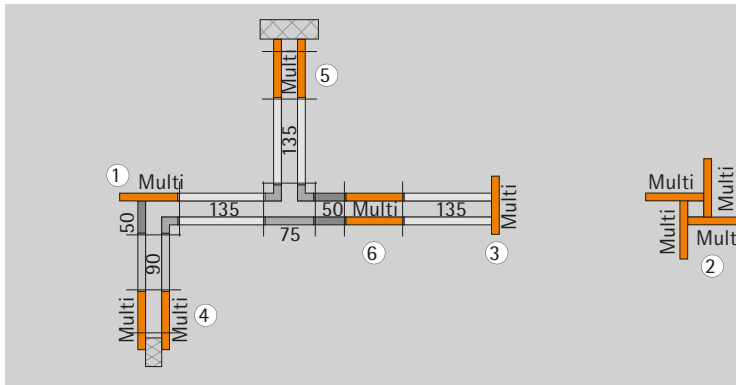



## Midi panel



Natural gas storage stations, D-Etzel; Knoll GmbH, D-Haren

A medium-dimensional large-size panel, the 135-cm-wide Midi panel has a number of benefits both in vertical and horizontal orientations. Altogether eight tying options are available for this panel, four of which are internal. Depending on the use, it can be tied so as to minimise the total number of tie holes required.

Horizontal placement (H = 135 cm):  
Lower tie holes – internal  
Upper tie holes – external

Vertical placement (H = 270 cm):  
Externally positioned tie holes

Connection with existing walls (H = 270 cm):  
One side – internal  
Other side – external

Furthermore, the 135-cm-wide Midi panel fills the gap between the 240-cm-wide large-size panel and the compensation panels, which begin at 90 cm. For filling in remaining distances, it is often sufficient to use one Midi panel instead of two smaller panels. Midi panels can be transported with a small lorry suitable for small loads.



LOGO.3 midi-panel 340x135 cm



LOGO.3 midi-panel 270x135 cm



Horizontally and vertically use of LOGO.3 midi-panel 340x135 cm and LOGO.3 midi-panel 270x135 cm

- Flexible application as wall panel
- Can be used both horizontally and vertically
- Reduces the need to stock various panel widths
- High repeated usage
- Reduces tie requirements to a minimum



Parzival school, D- Karlsruhe; Weisenburger Bau GmbH

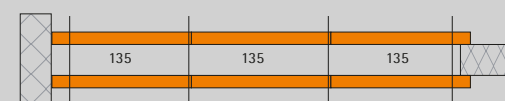

## Foundations and stop-end formwork

The narrow panel widths or small panel heights of the LOGO.3 range can be used with foundations or floor slab stop-end formwork. Both aluminium and steel panels are suitable. They are light enough to be moved by hand, which means that a crane is not necessarily required for foundation work.



LOGO.3 / LOGO alu panel 270 x 90 cm with 8 tie points

- Four outside and inside tie points each enable a flexible use.
- Vertical or horizontal position: In vertical position the outside tie-point is used at the panel joint. In horizontal position you can use the necessary lower inside tie point of the panel.
- Use as formwork for foundations, for height extensions and small wall heights, beams, parapet walls, etc.
- All other panel widths in height 90 cm are available within the system
- Compatible with all PASCHAL systems

### LOGO foundation strap

The foundation strap is a practical and favourably priced alternative as a lower formwork anchor. It is simple to lay, requires no additional connecting elements to the formwork panels and still absorbs all acting forces safely. As a hidden anchor, it also saves having to provide additional working space and perform expensive digging.



LOGO foundation strap

- Possible to work without a crane
- Lower cost than conventional formwork
- Use of foundation strap saves digging and resealing of large working space

### LOGO foundation tie clamp

- Simple installation with the LOGO.3 wall formwork. The LOGO foundation tie clamp will be attached to the long hole of the LOGO profile without any additional parts.
- Less work space necessary in comparison to assembly with tie rods. Reduced earthwork operations with less excavations and fill-ups.
- Small LOGO.3 panels can also be put in horizontal position as foundation formwork.
- With the use of the foundation tie clamp below the formwork there is no collision with existing reinforcement or other already mounted parts.
- Delivered as roll the perforated tie can be cut at any foundation width.
- Crossing installation is also possible with block foundations.



LOGO foundation tie clamp



Perforated tie



## Multi-Column



Hospital, F-Straßburg; Eiffage Construction Alsace, F-Oberhausbergen

Formwork for rectangular or square column sections between 20 cm and 75 cm length (60 cm for LOGO alu) can be made in accordance with the windmill principle using four LOGO.3 multi-purpose panels. Additional profiles are available in the multi-purpose panels, which allows for joining using a locking screw. The gradation is 5 cm. Other shore column sections are also available, for example angular. Inside corner posts and smaller panel dimensions are then used. For larger column sections, the required ties can be set in the panels or the entire column formwork is surrounded with steel walers.

For more details on column formwork, please see the chapter of that name in this handbook and in the technical information.

- Multi-purpose panel as column formwork
- Side length 20 – 75 cm
- Gradation 5 cm
- Rectangular, square



Waste incineration plant „Amager Bakke“,  
DK-Copenhagen; NCC, DK-Copenhagen



Garage, CH-Kerns; Baumeier Leitungsbau AG,  
CH-Luzern

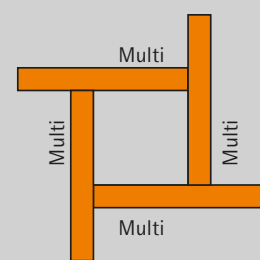



## Housing projects

The LOGO.3 range has proven itself in apartment block construction thanks to its comprehensive panel assortment in heights and widths. It is therefore able to cope with the entire range of requirements occurring on all building sites. Complex and angular ground plans can be casted without the need for additional local formwork as easily as straight walls. The secret lies in selecting the right combination of all available panels, beginning with the 240-cm-wide large-size panel and moving all the way down to the 5 cm and 6 cm steel filler pieces or 1-4 cm plastic filler pieces. With the 1 cm grid dimension, all wall lengths can be casted from the smallest bay or shaft to a fully-dimensioned wall.

Even if right angles are also required or corners with acute or obtuse angles, or height offsets are to be balanced out, the available small parts mean that the solution remains economic, thanks to its systemic nature, and no expensive compensational construction is necessary, that would otherwise have to be manufactured especially for the purpose. The combination of panels in vertical and horizontal orientation, with or without extension, means that many possibilities for height adjustment are available on site.

There are clearly no limits to the flexibility and adaptability of LOGO.3 formwork.



Residential building, D-Munich; Bau-Dosch GmbH, D-Seefeld



Residential complex, D-Munich; S. Pöttinger GmbH & Co. KG Bauunternehmung, D-Ottobrunn





## Shafts - easy dismantling



Residential and commercial building, D-Lahr; Ritter-Bau GmbH, D-Schutterwald

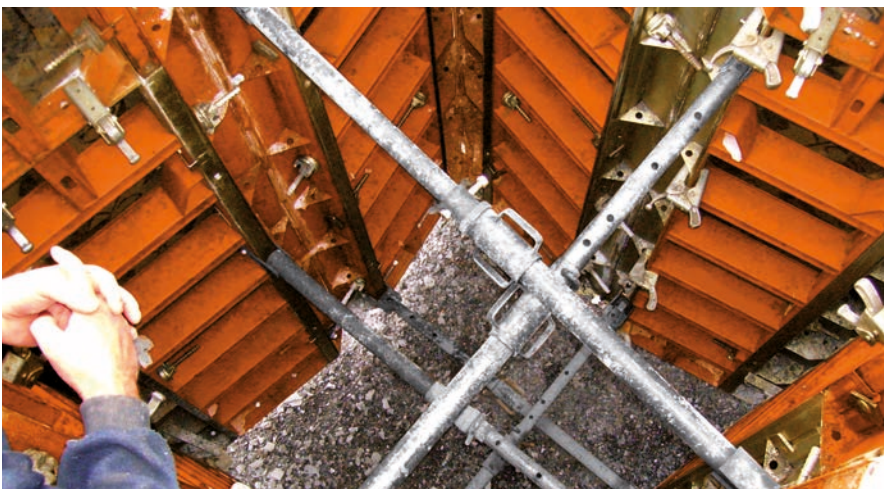

Building for administration, CH-Balzers; Meisterbau AG, CH-Balzers

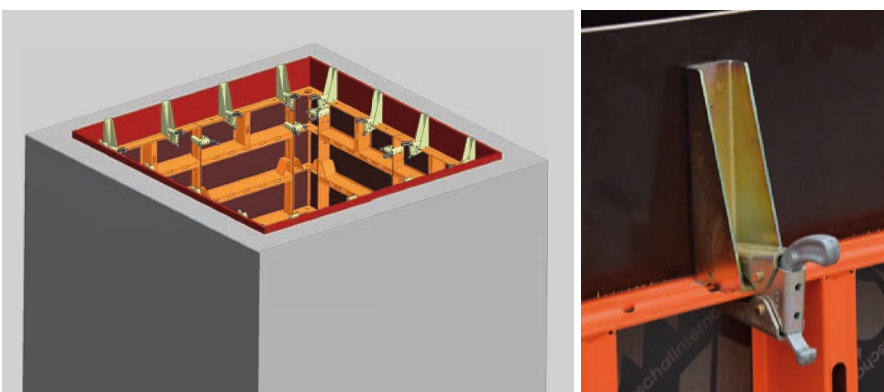

Simple assembly on the upper panel frame of LOGO.3 panels with the wedge clamp.

### LOGO.3 Dismantling inside corner post

The inner corner posts of shafts and short wall panels between rising walls can be stripped without the formwork having to be dismantled into several parts. There is a hexagonal nut at the upper side of the inside corner post which will be turned to dismantle (clockwise) for dismantling and anticlockwise for pushing in right position before concreting. A spanner size 36 or a tie rod DW15 put in the hole of the hexagonal nut will be sufficient for turning.

- Optimized dismantling procedure
- Complete inner formwork can be moved as a whole unit
- Enormous gain of time

### LOGO.3 hinged corner posts

Alternatively, the interior formwork can be made in folding form. Hinged corner posts are integrated into the corners and the wall panels, allowing the entire shaft to be folded and adjusted with a single crane application. In this manner, it is possible to avoid the constant, cost-intensive casting and dismantling processes over several sections.

- Folding shaft can be implemented as a unit

### LOGO.3 Extension bracket

For mounting of plywood stripes for small extensions by site. Application under close circumstances like shafts where horizontal panels cannot be used or where still a high portion of filler panels despite use of horizontal panels is.



## Industrial construction

Industrial construction commonly involves halls, which are erected for the purposes of manufacturing, storing, or selling a wide variety of products. The adaptability of LOGO.3 formwork is just as important with these buildings, as they do not only involve the construction of large wall panels, but they also require smaller areas for lift shafts, stairwells, and administrative areas. Additional demands on the formwork can come from columns, oblique angles or wall breaks. The comprehensive panel assortment in heights and widths in the LOGO.3 formwork range again guarantees the ability to work with a system, without the need for on-site adjustment.

5



Mobility centre, D-Karlsruhe; Züblin, construction engineering Karlsruhe



Production hall, D-Telgte; August Gründker Bauunternehmen & Bedachungen GmbH, D-Glandorf



Production hall, D-Endingen; Ernst Späth, D-Endingen





Gare Pont Rouge, L- Luxembourg; Consortium „TRALUX and Lux TP S.A.“, L- Luxembourg

## Civil engineering

The 240-cm-wide large-size panels in heights of 270 cm, 305 cm, and 340 cm mean that the LOGO.3 range is a formwork system that is highly suitable for use in civil engineering. It is common in this field to be faced with the task of providing formwork and concrete construction for large areas using few individual sections, as economically and with as high a quality as possible.

In the case of high walls, it is possible to create several rows of large-size panels, and the sturdy combination rail ensures that the entire unit possesses a sufficient level of rigidity. The LOGO.3 is not affected by repeated dropping and lifting for large-area repositioning or cleaning. Alignment is maintained, even in terms of height.

The use of large-size panels also results in an ordered pointing and anchor structure, with a low number of joints. The number of ties required is also kept to a minimum.

Additionally, the installed high-quality, single-piece plywood enables perfect concrete surfaces.



Round pinnacle of sewage treatment plant digestion tower, D- Rollsdorf; beton & rohrbau GmbH & Co.KG, D-Halle



Bridge abutment „Pont Citadelle“, F-Strasbourg; GTM Halle





## Work safety / platforms

### PASCHAL Secuset

The professional lateral protection system from PASCHAL complies with the latest safety standard DIN EN 13374, thus making a significant contribution to smooth and safe construction workflows. Key element is the railing post, which can be used for a range of applications when combined with various connecting parts.



PASCHAL Secuset

### Platform bracket

Work platforms can be created easily and cost-effectively with the LOGO platform bracket and on-site boards.



Platform brackets

### Concreting platform

As complete part, the concreting platform is comprised of two stiffening brackets, the boarding and a guard railing. All components are connected together by articulating joints and can be folded up in a space-saving way for transport or storage.

The platform can be connected to standing and lying panels, but also to several small panels. Compensation elements between two platforms are possible up to a length of 1.00 m.

The concreting platform is a fast and economical way to set up a safe working area with a width of 1.10 m and a length of 2.40 m. Added to that, all of the components necessary for safety are always automatically included on the main part. A lateral protection for the stop-end is also available.



Water reservoir, CH-Balzers; Unternehmer Meisterbau AG, CH-Balzers

- Unfolded and installed quickly as complete part
- No repeated loss and repurchase of timber for boarding and railings
- Wide and safe work area
- Permissible surface load 1,50 kN/m<sup>2</sup>

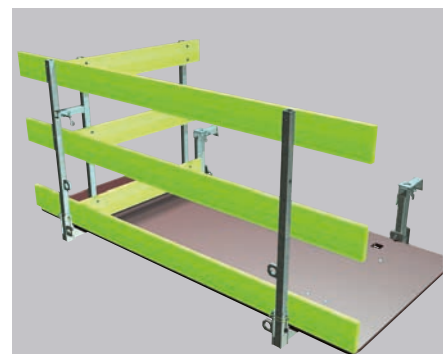





Warehouse, D-Kaiserslautern; Linnebacher Bau GmbH, D-Neunkirchen

## Multip

Multip from PASCHAL fulfils the most stringent safety standards and increases formwork and concreting efficiency. Assembly is fast and easy. It is performed with the formwork element lying on the ground which means the risk of hazards is considerably reduced. After fixing Multip to the formwork, the system just requires unfolding.

At PASCHAL, ladders, boards and railings are naturally included in the system unit so that it can be transported and set up on site without requiring extra assembly or additional components. The Multip simply remains attached when the formwork units are moved.

*Multip in combination with LOGO platform bracket:  
If a complete configuration with Multip is not economical or necessary, the system can be combined with the LOGO platform bracket.  
The Multip was only used for safe ascent in the example.*

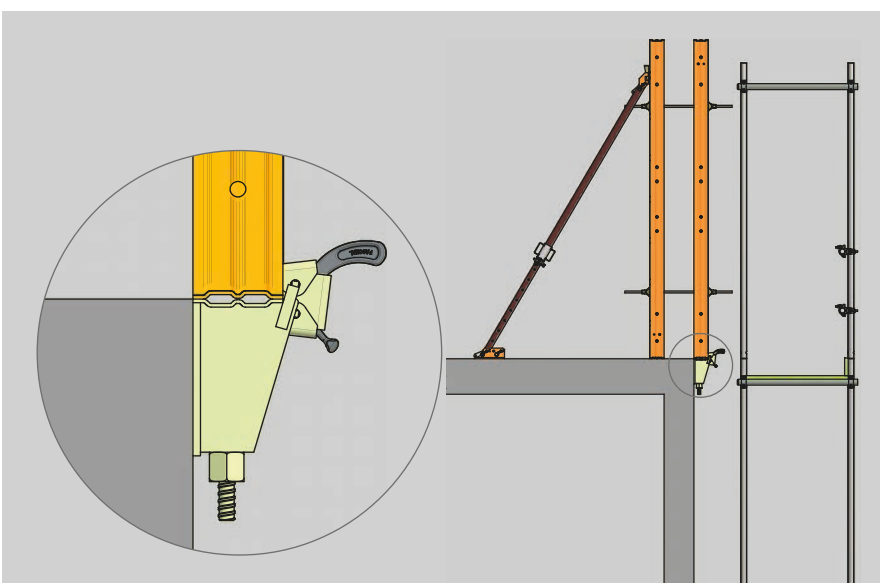

## Support bracket LOGO adjustable

Support of formwork during several concrete steps upwards where no platform shall be used.

- Admissible vertical load  $V_{adm.} = 15 \text{ kN}$
- Fixing possibility of formwork against lifting with wedge clamp
- Adjustable in height until 5,3 cm

## End finishing

Construction joints are inevitable if walls are formed in multiple cycles. These require the installation of plate strips and continued reinforcement.

### ① with spacer channel

The compressive forces that act upon the end finishing are diverted via spacer channels. The spacer channels are attached to the LOGO panels using locking screws. This replaces the tie in the compensation panel which is level with the end finishing.

11 holes allow wall thicknesses to be set up to 50 cm.

### ② with multi-waler

End finishing with a multi waler is used for wall thicknesses greater than 50 cm, conical walls and walls that cannot be formed with the spacer channel. The multi waler can be continuously adjusted. The multi-waler is attached to the panel using locking screws.

### ③ with multi-purpose panel

The multi-purpose panel is an additional version for end finishings up to 55 cm. However, it does not allow any further components, e.g. reinforcement.

The hole sequence in the multi-purpose panel allows wall thicknesses from 15 cm to 55 cm in increments of 5 cm. Compensation panels eliminate the need for a tie at the end of the wall.

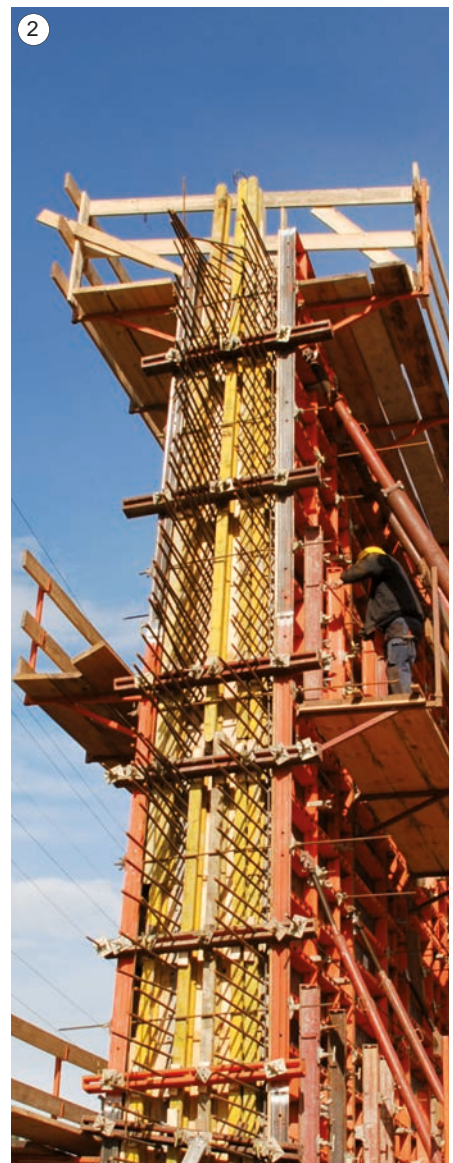
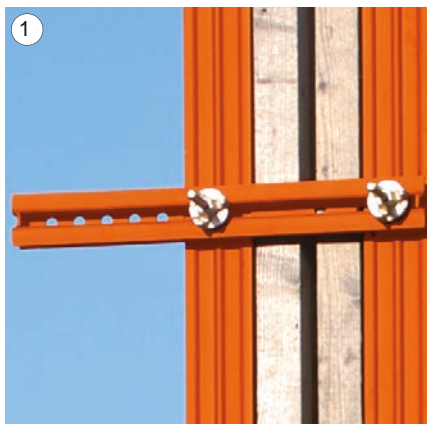
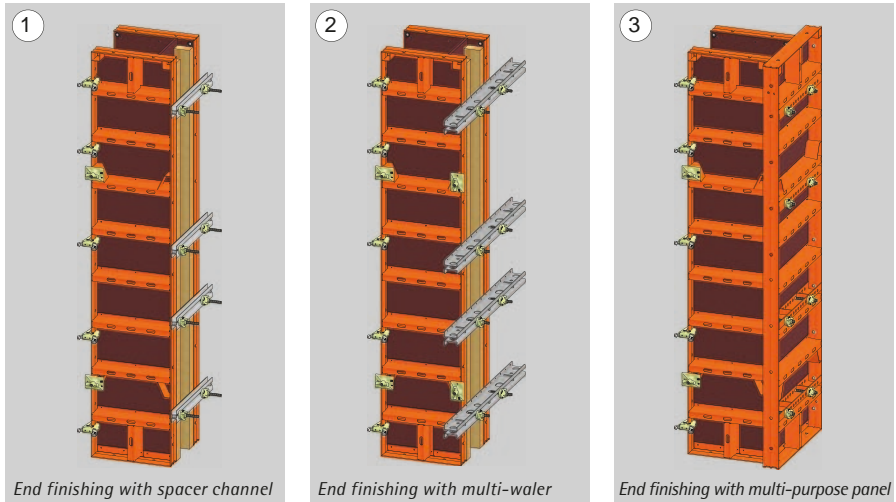





Four transport and stacking angles with securing bolts and twelve corner bearings are required per hanger or stack.



Corner bearing



## Transport

Ideally, formwork panels should be bundled into units for safe transport and space-saving storage.

## LOGO transport and stacking angles

Four equal-sized panels of LOGO formwork with a width between 45 cm and 240 cm can be joined together for transport and stacking angles. The insertion of corner bearings protects the plywood from abrasion damage.

## LOGO transport angles

Transport angle with foot for 2-12 LOGO panels.



Stack with 12 LOGO panels



Stacking pallet LOGO platform bracket

## Stacking pallet LOGO platform bracket

The stacking pallet for LOGO platform bracket acts as a means of transporting and storing the LOGO platform bracket (34 units).

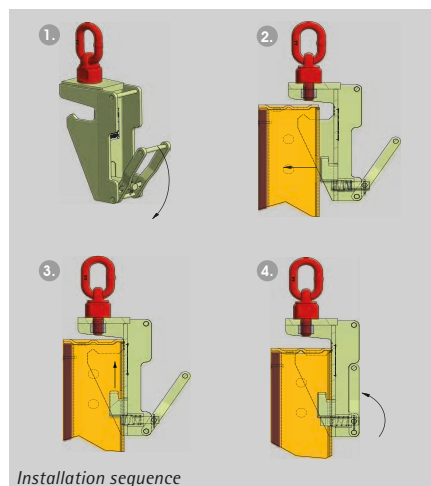









Installation sequence

## LOGO.3 crane lifting clamp KLHD

Load-bearing equipment for moving single panels of LOGO formwork or pre-assembled panel units.



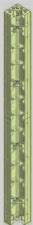





## Parts list

	Art.-N°	Item	kg		Art.-N°	Item	kg			
		LOGO.3 panel				LOGO.3 outside corner post				
	N179.001.2400	240 x 340 cm	400,00		N179.006.0001	340 cm	38,50			
	see too:						LOGO.3 hinged corner post outside			
	N176.001.3400	340 x 270 cm	463,00			N179.007.0001	12,5 x 12,5 x 340 cm	66,00		
	N175.001.3400	340 x 135 cm	260,00					LOGO.3 hinged corner post inside		
							N179.007.0002	30 x 30 x 340 cm	116,50	
							N187.500.0013	LOGO locking bow for hinged corner inside cpl.	0,81	
									LOGO.3 plastic filler piece	
								N179.011.1010	1 x 340 cm	3,70
								N179.011.1020	2 x 340 cm	7,40
			N179.011.1030	3 x 340 cm				10,10		
			N179.011.1040	4 x 340 cm	14,80					
			N179.011.1050	5 x 340 cm	19,40					
			N179.011.1060	6 x 340 cm	23,20					
		LOGO.3 multi-purpose panel				LOGO.3 filler plate				
	N179.004.0900	90 x 340 cm	162,00		N179.012.0002	5-10 x 340 cm cpl.	24,00			
							LOGO.3 Plastic dismantling wedge w/o locking screw			
						N275.001.0124	5 x 340 cm	19,50		
		LOGO.3 inside corner post								
	N179.005.0250	25 x 25 x 340 cm	78,00							
		LOGO.3 dismantling inside corner post								
N179.005.0251	25 x 25 x 340 cm	170,00								

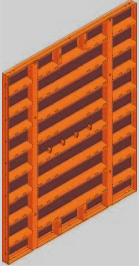
Subject to technical changes



## Parts list

	Art.-N°	Item	kg		Art.-N°	Item	kg							
	N179.013.0001	LOGO.3 fixing post 340 cm, for 21 mm plywood	9,80		N178.005.0251	LOGO.3 dismantling inside corner post 25 x 25 x 305 cm	156,00							
	N179.013.0002	340 cm, for 27 mm plywood	9,60				N178.006.0001	LOGO.3 outside corner post 305 cm	35,50					
	N178.001.2400	LOGO.3 panel 240 x 305 cm	372,00		N178.007.0001			LOGO.3 hinged corner post outside 12,5 x 12,5 x 305 cm	58,50					
	N178.001.1350	LOGO.3 midi-panel 135 x 305 cm	219,00						N178.007.0002	LOGO.3 hinged corner post inside 30 x 30 x 305 cm	105,00			
	N178.001.0900	LOGO.3 panel 90 x 305 cm	109,00	N187.500.0013	LOGO locking bow for hinged corner inside cpl.					0,81				
	N178.001.0750	75 x 305 cm	96,00							N178.011.1010	LOGO.3 plastic filler piece	1 x 305 cm	3,30	
	N178.001.0600	60 x 305 cm	84,00									N178.011.1020	2 x 305 cm	6,60
	N178.001.0550	55 x 305 cm	79,00									N178.011.1030	3 x 305 cm	9,90
	N178.001.0500	50 x 305 cm	76,00									N178.011.1040	4 x 305 cm	13,20
	N178.001.0450	45 x 305 cm	71,50									N178.011.1050	5 x 305 cm	17,40
	N178.001.0400	40 x 305 cm	67,50									N178.011.1060	6 x 305 cm	20,90
	N178.001.0300	30 x 305 cm	58,00										N178.012.0002	LOGO.3 filler plate 5-10 x 305 cm cpl.
N178.001.0250	25 x 305 cm	51,50												
N178.001.0200	20 x 305 cm	48,00												
	N178.004.0900	LOGO.3 multi-purpose panel 90 x 305 cm	144,50											
	N178.005.0250	LOGO.3 inside corner post 25 x 25 x 305 cm	70,00											

Subject to technical changes



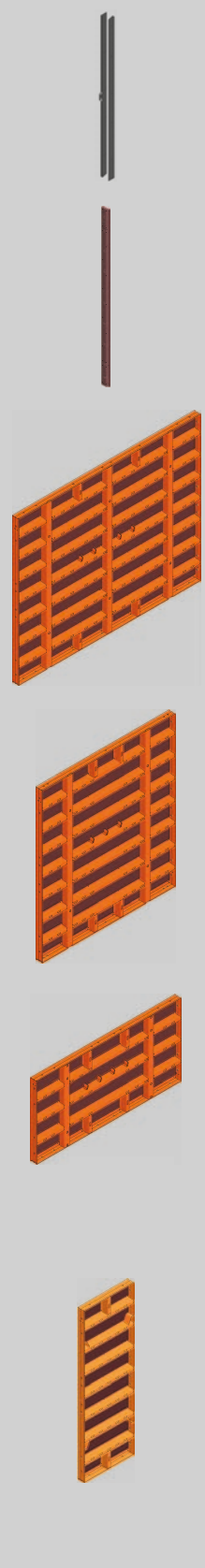
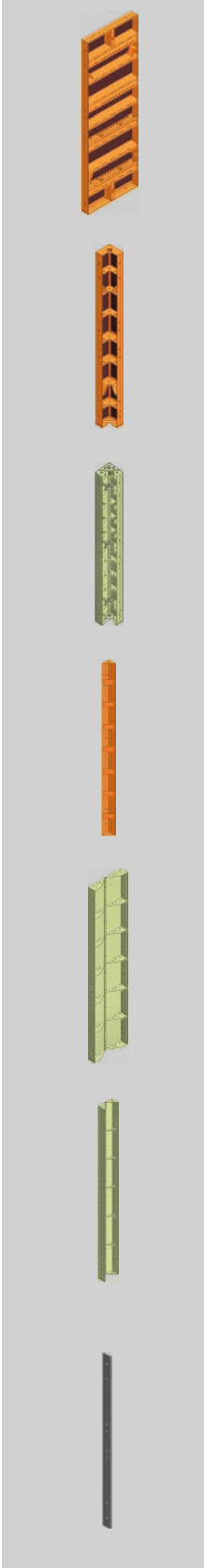











### Parts list

	Art.-N°	Item	kg		Art.-N°	Item	kg
	N275.001.0130	LOGO.3 Plastic dismantling wedge w/o locking screw 5 x 305 cm	17,50		N176.004.0900	LOGO.3 multi-purpose panel 90 x 270 cm	126,80
	N178.013.0001	LOGO.3 fixing post 305 cm, for 21 mm plywood	8,80		N176.005.0250	LOGO.3 inside corner post 25 x 25 x 270 cm	61,40
	N178.013.0002	305 cm, for 27 mm plywood	8,60		N176.005.0251	LOGO.3 dismantling inside corner post 25 x 25 x 270 cm	137,00
	N176.001.3400	LOGO.3 panel 340 x 270 cm	463,00		N176.006.0001	LOGO.3 outside corner post 270 cm	31,50
	N176.001.2400	LOGO.3 panel 240 x 270 cm	312,50		N176.007.0002	LOGO.3 hinged corner post inside 30 x 30 x 270 cm	92,00
	N176.001.1350	LOGO.3 midi-panel 135 x 270 cm	201,00		N187.500.0013	LOGO locking bow for hinged corner inside cpl.	0,81
	N176.001.0900	LOGO.3 panel 90 x 270 cm	95,60		N176.007.0001	LOGO.3 hinged corner post outside 12,5 x 12,5 x 270 cm	54,22
	N176.001.0750	75 x 270 cm	84,20				
	N176.001.0600	60 x 270 cm	73,80		N176.011.1010	LOGO.3 plastic filler piece 1 x 270 cm	3,00
	N176.001.0550	55 x 270 cm	69,40		N176.011.1020	2 x 270 cm	6,00
	N176.001.0500	50 x 270 cm	67,00		N176.011.1030	3 x 270 cm	9,00
	N176.001.0450	45 x 270 cm	62,60		N176.011.1040	4 x 270 cm	12,00
	N176.001.0400	40 x 270 cm	59,20		N176.011.1050	5 x 270 cm	15,40
	N176.001.0300	30 x 270 cm	51,00		N176.011.1060	6 x 270 cm	18,50
N176.001.0250	25 x 270 cm	45,40					
N176.001.0200	20 x 270 cm	42,00					

Subject to technical changes



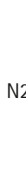









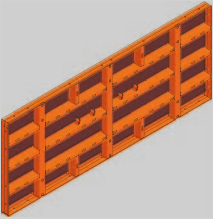

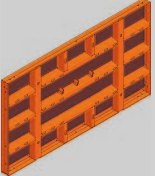

## Parts list

	Art.-N°	Item	kg		Art.-N°	Item	kg
	N176.012.0002	LOGO.3 filler plate 5 - 10 x 270 cm cpl.	19,50		N177.005.0251	LOGO.3 dismantling inside corner post 25 x 25 x 240 cm	115,00
	N275.001.0125	LOGO.3 plastic dis- mantling wedge w/o locking screw 5 x 270 cm	15,40		N177.006.0001	LOGO.3 outside corner post 240 cm	25,50
	N176.013.0001	LOGO.3 fixing post 270 cm, for 21 mm plywood	7,80		N177.007.0001	LOGO.3 hinged corner post outside 12,5 x 12,5 x 240 cm	48,00
	N176.013.0002	270 cm, for 27 mm plywood	7,60		N177.007.0002	LOGO.3 hinged corner post inside 30 x 30 x 240 cm	83,00
	N177.001.0900	LOGO.3 panel 90 x 240 cm	88,60		N187.500.0013	LOGO locking bow for hinged corner inside cpl.	0,81
	N177.001.0750	75 x 240 cm	78,20		N177.011.1010	LOGO.3 plastic filler piece 1 x 240 cm	2,60
	N177.001.0600	60 x 240 cm	68,40		N177.011.1020	2 x 240 cm	5,20
	N177.001.0550	55 x 240 cm	65,60		N177.011.1030	3 x 240 cm	7,80
	N177.001.0500	50 x 240 cm	60,60		N177.011.1040	4 x 240 cm	10,40
	N177.001.0450	45 x 240 cm	57,80		N177.011.1050	5 x 240 cm	13,70
	N177.001.0400	40 x 240 cm	55,20		N177.011.1060	6 x 240 cm	16,40
	N177.001.0300	30 x 240 cm	47,60		N177.012.0002	LOGO.3 filler plate 5 - 10 x 240 cm cpl.	17,30
	N177.001.0250	25 x 240 cm	42,30		N275.001.0126	LOGO.3 plastic dis- mantling wedge w/o locking screw 5 x 240 cm	13,80
	N177.001.0200	20 x 240 cm	39,80				
	N177.004.0900	LOGO.3 multi-purpose panel 90 x 240 cm	119,80				
	N177.005.0250	LOGO.3 inside corner post 25 x 25 x 240 cm	57,00				

Subject to technical changes













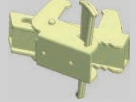
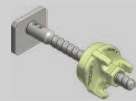

### Parts list

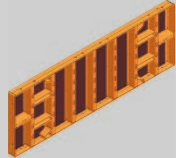
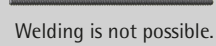
	Art.-N°	Item	kg		Art.-N°	Item	kg	
	N177.013.0001	LOGO.3 fixing post 240 cm, for 21 mm plywood	6,90		N175.005.0251	LOGO.3 dismantling inside corner post 25 x 25 x 135 cm	73,00	
	N177.013.0002	240 cm, for 27 mm plywood	6,70					
	N175.001.3400	LOGO.3 midi-panel 340 x 135 cm	260,00		N175.006.0001	LOGO.3 outside corner post 135 cm	15,50	
	N175.001.2700	LOGO.3 panel 270 x 135 cm	186,00		N175.007.0001	LOGO.3 hinged corner post outside 12,5 x 12,5 x 135 cm	28,00	
	N175.001.2400	240 x 135 cm	166,50					
	N175.001.1350	LOGO.3 on top panel 135 x 135 cm	89,00		N175.007.0002	LOGO.3 hinged corner post inside 30 x 30 x 135 cm	46,20	
					N187.500.0013	LOGO locking bow for hinged corner inside cpl.	0,81	
	N175.001.0900	LOGO.3 panel 90 x 135 cm	53,80		N175.011.1010	LOGO.3 plastic filler piece 1 x 135 cm	1,50	
	N175.001.0750	75 x 135 cm	48,00		N175.011.1020	2 x 135 cm	3,00	
	N175.001.0600	60 x 135 cm	41,60		N175.011.1030	3 x 135 cm	4,50	
	N175.001.0550	55 x 135 cm	39,80		N175.011.1040	4 x 135 cm	6,00	
	N175.001.0500	50 x 135 cm	38,00		N175.011.1050	5 x 135 cm	7,70	
	N175.001.0450	45 x 135 cm	35,80		N175.011.1060	6 x 135 cm	9,30	
	N175.001.0400	40 x 135 cm	34,60					
	N175.001.0300	30 x 135 cm	29,00		N175.012.0002	LOGO.3 filler plate 5 - 10 x 135 cm cpl.	10,00	
	N175.001.0250	25 x 135 cm	24,70					
	N175.001.0200	20 x 135 cm	22,90					
	N175.004.0900	LOGO.3 multi-purpose panel 90 x 135 cm	68,40			N275.001.0127	LOGO.3 plastic dismantling wedge w/o locking screw 5 x 135 cm	7,80
		N175.005.0250	LOGO.3 inside corner post 25 x 25 x 135 cm		33,00		N175.013.0001	LOGO.3 fixing post 135 cm, for 21 mm plywood
				N175.013.0002	135 cm, for 27 mm plywood		3,80	

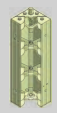
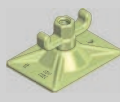
Subject to technical changes



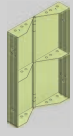













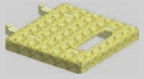



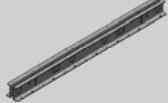



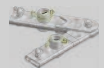

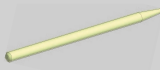



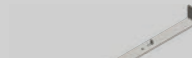



## Parts list

	Art.-N°	Item	kg		Art.-N°	Item	kg											
	N173.001.0900	LOGO.3 panel 90x90 cm	41,50		N173.012.0002	LOGO.3 filler plate 5-10x90 cm cpl.	7,20											
	N173.001.0750	75x90 cm	36,00			N275.001.0128	LOGO.3 plastic dismantling wedge w/o locking screw 5 x 90 cm	5,20										
	N173.001.0600	60x90 cm	31,00				N173.013.0001	LOGO.3 fixing post 90 cm, for 21 mm plywood	2,60									
	N173.001.0550	55x90 cm	29,50				N173.013.0002	90 cm, for 27 mm plywood	2,50									
	N173.001.0500	50x90 cm	28,00					N187.500.0100	LOGO wedge clamp (curved)	1,80								
	N173.001.0450	45x90 cm	26,50						N187.500.0004	Multi clamp LOGO 0-10 cm	5,30							
	N173.001.0400	40x90 cm	25,00						N187.500.0175	0-20 cm	6,50							
	N173.001.0300	30x90 cm	21,00							N187.500.0002	LOGO locking screw DW 15x215 cpl.	1,10						
	N173.001.0250	25x90 cm	19,00								N187.500.0106	LOGO locking screw DW 15x 100 cpl.	1,00					
	N173.001.0200	20x90 cm	17,50									N287.500.0026	Combi clamp LOGO-N/TR/R	2,20				
		N173.001.2700	LOGO.3 panel with 8 tie points 270x90 cm									101,50		N189.006.0850	Tie rod DW 15x 85cm	1,19		
		N173.004.0900	LOGO.3 multi-purpose panel 90x90 cm	57,50								N189.006.1000		DW 15x 100cm	1,40			
			N173.005.0250	LOGO.3 inside corner post 25x25x90 cm	25,00							N189.006.1350		DW 15x 135cm	1,85			
				N173.005.0251	LOGO.3 dismantling inside corner post 25x25x90 cm	53,00								N189.001.0059	Plate with ball-and-socket joint DW 15, 10x 14 cm inclin. max.12°	1,29		
					N173.006.0001	LOGO.3 outside corner post 90 cm								9,50		N187.500.0166	Plate LOGO horizontal 60x12x170	0,85
						N173.007.0001	LOGO.3 hinged corner post outside 12,5x 12,5x 90 cm							18,50				
							N173.007.0002	LOGO.3 hinged corner post inside 30x30x90 cm						32,50				
							N187.500.0013	LOGO locking bow for hinged corner inside cpl.						0,81				
								N173.011.1010	LOGO.3 plastic filler piece 1 x 90 cm					1,00				
								N173.011.1020	2 x 90 cm	2,00								
								N173.011.1030	3 x 90 cm	3,00								
	N173.011.1040							4 x 90 cm	4,00									
N173.011.1050	5 x 90 cm							5,20										
N173.011.1060	6 x 90 cm	6,20																

Subject to technical changes











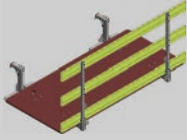

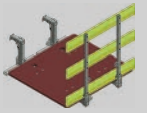

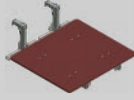



### Parts list

	Art.-N°	Item	kg		Art.-N°	Item	kg
	N189.001.0002	Hexagon nut DW15	0,20		N187.500.0021	Support for walers DW 15 clamping length 6-20 cm L/N/A	1,95
	N186.000.0068	Support bracket LOGO adjustable	7,60		N187.500.0022	Hook-headed bolt DW 15 chromate coated 300/240	0,53
	N187.500.0132	LOGO.3 extension bracket 25 cm chromate coated for 21mm plywood	1,70		N187.500.0024	Hook-headed bolt DW 15 chromate coated 400/340	0,70
	N187.500.0162	Step L/N	4,70		N183.500.0034	Hook-headed bolt DW 15 chromate coated 220/160	0,40
	N187.500.0006	LOGO spacer channel 15-50 cm	7,10		N187.500.0008	LOGO tie rod guide	2,35
	N187.500.0164	Multi waler 140	16,80		N187.500.0040	Dismantling aid LOGO	6,00
	N187.500.0165	Clamping piece 10 cm L/N/A	1,30		N187.500.0023	Uni carbide scraper LOGO 100x850 cm	1,20
	N187.500.0168	Hinged part multi waler cpl. galvanized	5,00		N183.500.0014	Assembly and dismantling tool L/A	3,10
	N187.500.0013	LOGO locking bow for hinged corner inside cpl.	0,81		N187.500.0026	LOGO centering piece	0,98
	N187.500.0091	LOGO crane lifting clamp KLD 3D chromate coated adm. cap. 1200 kg	6,90		N187.501.0120	LOGO foundation strap 12,0 cm	0,29
	N187.500.0090	LOGO crane lifting clamp KLF 3D galvanized adm. cap. 1200 kg	5,80		N187.501.0150	LOGO foundation strap 15,0 cm	0,31
	N187.500.0160	LOGO crane lifting clamp KLHD chromate coated adm. cap. 1200 kg	6,90		N187.501.0175	LOGO foundation strap 17,5 cm	0,32
	N187.500.0161	LOGO-Krananhängung KLHF galvanized adm. cap. 1200 kg	5,70		N187.501.0200	LOGO foundation strap 20,0 cm	0,34
	N187.500.0019	LOGO loading auxiliary	0,85		N187.501.0240	LOGO foundation strap 24,0 cm	0,37
					N187.501.0250	LOGO foundation strap 25,0 cm	0,39
					N187.501.0300	LOGO foundation strap 30,0 cm	0,41
					N187.501.0350	LOGO foundation strap 35,0 cm	0,44
					N187.501.0365	LOGO foundation strap 36,5 cm	0,45
					N187.501.0400	LOGO foundation strap 40,0 cm	0,47
					N187.501.0450	LOGO foundation strap 45,0 cm	0,50
					N187.501.0500	LOGO foundation strap 50,0 cm	0,54
					N187.501.0600	LOGO foundation strap 60,0 cm	0,60
					N187.501.0700	LOGO foundation strap 70,0 cm	0,67
					N187.501.0800	LOGO foundation strap 80,0 cm	0,74
					N187.501.0900	LOGO foundation strap 90,0 cm	0,80
					N187.501.1000	LOGO foundation strap 100,0 cm	0,87

Subject to technical changes

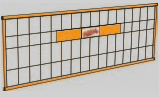
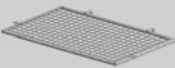

## Parts list

	Art.-N°	Item	kg		Art.-N°	Item	kg
	N187.500.0125	Foundation tie clamp for L/N	2,15		N187.500.0097	Concreting platform LOGO 120x238cm folding	120,00
	N940.100.0000	Perforated foundation tie 50x2 roll at 25 m perforation 20/22 each 5 cm	15,70		N187.500.0120	Concreting platform LOGO 120x124 cm folding	91,30
	N187.500.0005	LOGO platform bracket	13,00		N187.500.0130	Concreting platform LOGO for inside corner folding	68,00
	N187.500.0163	Rack for LOGO platform brackets	97,50		N187.500.0114	Lateral protection for concreting platform	16,17
	N189.000.0001	Support LOGO cpl. lateral protection Secuset	3,10		N187.500.0133	Precast wall adaptor for concreting platform	9,40
	N189.000.1001	Railing post 120 cm lateral protection Secuset	3,20		N940.014.0071	Installation set for precast wall adaptor	0,05
	N189.000.1010	Support for toe board lateral protection Secuset	0,46		N287.500.0045	Transport angle cpl. for 4 LOGO large size panels Kompletter Satz bestehend aus: 4 Transport- und Stapelwinkel 4 Sicherheitsbolzen 12 Ecklager	67,60
	N189.000.1011	Support for protection fence Secuset	0,21		N287.500.0032	Transport angle cpl. for 5 to 12 LOGO panels	11,40
	N189.000.0003	LOGO platform bracket Secuset	9,40		N189.002.0003	Transportation box hot-dip galvanized 1200x800x610 mm	86,50
	N189.000.1035	Lateral protection fence 230x80cm Secuset	10,10		N940.009.0019	Cover lattice box/transp. hot-dip galvanized 110x68x3,5 cm	6,70
	N189.000.1036	Lateral protection fence 130x80cm Secuset	6,60				

Subject to technical changes

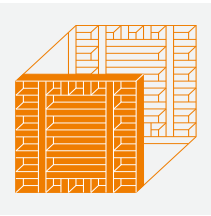

# LOGO.alu

Wall formwork





## Technical data

LOGO.alu		
Max. concrete pressure		60 kN/m <sup>2</sup> as per DIN 18218
Tolerances of deflection		According to DIN 18202, table 3, line 6
Panel heights		270/135/90 cm
Frame depth		12 cm
Frame		Angle section, powder-coated
Cross section		Rectangular hollow profile, suitable to take accessories, powder-coated
Plywood		16 mm thick, 12-ply Finnish birch plywood
Tie rod		DW 15, max. safe working load 90 kN (not weldable)
Panel widths		90/75/60/55/50/45/40/30 cm
Multi-purpose panel		Outside corner panel, wall thickness 10 – 50 cm Variable column formwork 20 – 75 cm in steps of 5 cm
Plastic filler pieces		Widths 1/2/3/4/5/6 cm
Fixing post		Compensations with 21 mm plywood
Inside corner post		Leg length 25 cm
Dismantling inside corner post		Leg length 25 cm
Hinged corner post	Inside	Leg length 30 cm, adjustable from 60 – 180 degrees Fixing for 60/90/135 degrees
	Outside	Leg length 12,5 cm, adjustable from 60 – 180 degrees
Wedge clamp	Connecting piece	Panels, max. tension 7 kN
Combi clamp	Connecting piece	LOGO-Modular/GE; LOGO-Trapez
Multi clamp	Connecting piece	Variable up to compensation of 10 / 20 cm
Locking screw	Connecting piece	Multi-purpose panels Plastic filler pieces up to 12 cm Steel filler pieces 5 and 6 cm Height extensions Stop ends Max. tension force in screw axis 22 kN Max. shear force 20 kN
Spacer channel		Stop end and tensioning on top Wall thickness 15 – 50 cm in steps of 5 cm (24/36,5 cm)
Crane lifting clamp		Max. safe working load 1200 kg
Loading auxiliary		For crane transport of bundled panels Maximum 1900 kg (4 loading auxiliaries)
Platform bracket		Walking width 1 m Max. safe working load for 2 m bracket spacing 3 kN/m <sup>2</sup>
Suspending piece for props		For connecting supports to formwork
Support for walers DW15		Fixing of squared timbers, wooden girders, supporting jacks and steel walers to cross sections Clamp range 6 – 20 cm

## LOGO.alu – the solid aluminium formwork

LOGO.alu formwork is light and can be moved by hand, while possessing virtually all characteristics of a large area system. It is suitable for use on building sites where no crane is available.

The largest panel is 90cm wide and 270cm high, yet weighs only 59kg while still offering a form area of 2,43 m<sup>2</sup>. For the entire system, a poured concrete pressure of 60 kN/m<sup>2</sup> by DIN 18218 is permissible. Handles are included in all panels to simplify transportation and installation. LOGO.alu is also available in a comprehensive panel assortment, all the way down to 5 and 6 cm steel filler pieces and 1-4 cm plastic filler pieces, removing the need for extra on-site solutions, and ensuring that formwork costs remain low whatever the project. All accessories from the steel range can be used (wedge clamps, locking screw, platform bracket, spacer channel, props, etc.).

- Low weight to enable manual operation
- Comprehensive panel assortments
- Compatible with LOGO.3
- Same accessories
- Same functional profile
- Robust frame

For this reason, it is also possible to mix steel and aluminium panels. This can be of benefit in situations where a crane is available on the site but it is not continuously available for formwork activities. Small wall sections or corner areas can be formed in a single work cycle using the aluminium panels, and the crane reserved for large wall sections (using large-size panels).



Residential building, CH-Cortailod; Duckert Pierre SA; CH-Areuse





Valley station, inclined elevator at Ehrenhöhenstein Fortress; HTB Hoch-Tief-Bau Imst Ges.m.b.H



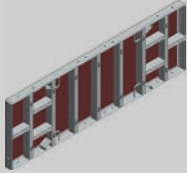

## Parts list

	Art.-N°	Item	kg		Art.-N°	Item	kg
		<b>LOGO.alu panel</b>			N173.901.2700	<b>LOGO.alu panel with 8 tie points</b> 270x90 cm	66,00
	N176.901.0900	90 x 270 cm	59,90				
	N176.901.0750	75 x 270 cm	52,70				
	N176.901.0600	60 x 270 cm	45,50				
	N176.901.0550	55 x 270 cm	43,10				
	N176.901.0500	50 x 270 cm	41,00				
	N176.901.0450	45 x 270 cm	38,60				
	N176.901.0400	40 x 270 cm	36,20				
N176.901.0300	30 x 270 cm	30,30		N187.500.0136	<b>LOGO.alu extension bracket 25 cm powder-coated for 21 mm plywood</b>	1,70	
	<b>LOGO.alu multi-purpose panel</b>						
N176.904.0750	75 x 270 cm	60,10					
	<b>LOGO.alu inside corner post</b>						
N176.905.0250	25 x 25 x 270 cm	39,00					
	<b>LOGO.alu panel</b>						
N175.901.0900	90 x 135 cm	36,00					
N175.901.0750	75 x 135 cm	29,50					
N175.901.0600	60 x 135 cm	25,50					
N175.901.0550	55 x 135 cm	24,00					
N175.901.0500	50 x 135 cm	22,50					
N175.901.0450	45 x 135 cm	21,00					
N175.901.0400	40 x 135 cm	19,50					
N175.901.0300	30 x 135 cm	16,50					
	<b>LOGO.alu multi-purpose panel</b>						
N175.904.0750	75 x 135 cm	36,00					
	<b>LOGO.alu inside corner post</b>						
N175.905.0250	25 x 25 x 135 cm	22,00					

6



Subject to technical changes

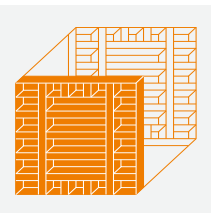

# LOGO.pro





## One-sided anchor system

The LOGO.pro is designed for use with the one-sided anchoring technology, but can also be anchored conventionally (from both sides). To this end, the use of standard tension material and cladding tubes facilitate work considerably. One-sided operation saves time and money and is ideal for working in confined spaces.

### Technical Data

LOGO.pro	
Max. concrete pressure	70kN/m <sup>2</sup> according DIN 18218
Tolerances of deflection	According DIN 18202, table 3, line 6
Panel widths	240/135/90/75/60/45/30 cm
Panel heights	for now 270 cm
Frame depth	12 cm
Plywood	16 mm thick, 12-ply Finnish birch plywood
Frame	Profiled flat steel frame of high-strength steel
Outside corner post	Side length 50 cm
Inside corner post	Side length 25 cm
Plastic filler pieces	Widths 5/6 cm with openings for ties, Widths 1/2/3/4 cm without openings for ties

## LOGO.pro - Optimised working with one-sided anchor technology

LOGO.pro's one-sided anchor technology means that the tie points can be operated by just one person. This not only makes optimised working with low manpower requirements possible, but also facilitates working in confined spaces.

7

### Innovative addition to the LOGO range

This new wall formwork consists of a profiled, high-strength flat steel frame and it provides the same robustness and reliability as the familiar LOGO.3 wall formwork.

As usual with PASCHAL, LOGO.pro features intelligent element sorting and a clear pattern of joints and anchors, making concrete surfaces visually appealing.

### Optimised working

The anchor points can be easily operated by just one person, even in confined spaces.

### Flexible anchors

Depending on requirements, the system can be anchored either on one side or conventionally (from both sides).

### Cost-effective installation of formwork

Thanks to standard tension material (DW15 and DW20) and compatibility with LOGO.3 and LOGO alu.

Have you already seen it?



In our application video we present all product highlights of the LOGO.pro formwork. It's worth taking a look!



*One-sided anchor technology makes the formwork anchors easy to operate by just one person*



*Residential complex with underground parking, Essen-Kettwig; Heinrich Temmink GmbH & Co. KG, Vreden*



## Conventional anchoring



Delivery condition with guide bushings in all panels:

*The tie rod (DW15 or DW20) with tube and plate with ball and socket joint on both sides can be used immediately in the conventional way.*

- LOGO.pro can be used variably with regard to anchor technology.
- Anchoring is done conventionally with guide bushings on both sides of the formwork.
- Standard material can be used for both anchor variants, no cost-intensive, conical anchors.

7

## One-sided anchoring

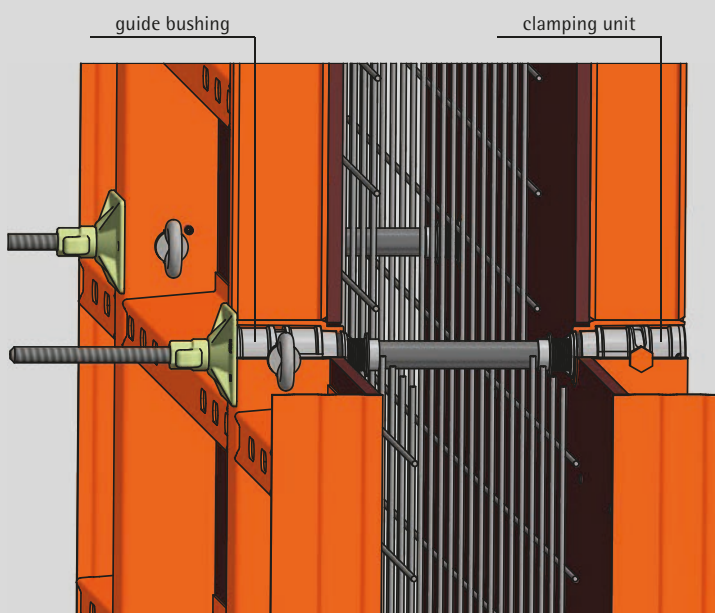

Conversion of the outer formwork with clamping unit:

*The tie rod with tube, guide bushing and plate with ball and socket joint can be turned in completely one-sided from the inner formwork.*

- With the clamping unit in the outer formwork, the tie point can be operated from one side.
- It is not necessary to change the tie rods for different wall thicknesses.
- The tie rods are easy to install and to remove.
- The maximum fresh concrete pressure is 70 kN/m<sup>2</sup>. The tolerances of deflection of DIN 18202, table 3, line 6 are observed.
- Depending on the existing fresh concrete pressure, DW15 or DW20 tie rods can be used.
- Formwork offsets are possible due to the rotatable support of the locking nut in the clamping unit.
- All LOGO.3 accessories are compatible.
- The one-sided operation creates a saving of time and thus also of costs due to lower staff requirements.

## One-sided anchoring with PASCHAL - it's that easy

### Simple operation thanks to interchange technology

PASCHAL has developed a new wall formwork that can be easily converted from two-sided to one-sided anchoring thanks to a smart changing system. No further special parts are required.

With the new LOGO.pro wall formwork, the medium-sized formwork manufacturer PASCHAL is completing its formwork range at the top end. The technical data correspond as far as possible to LOGO.3 - with one decisive difference: Depending on requirements, LOGO.pro can be anchored not only from both sides but also one-sided. The one-sided anchor technology used in LOGO.pro thus allows to operate the tie points by only one person - this allows optimised working with less manpower requirements or even where space is limited.

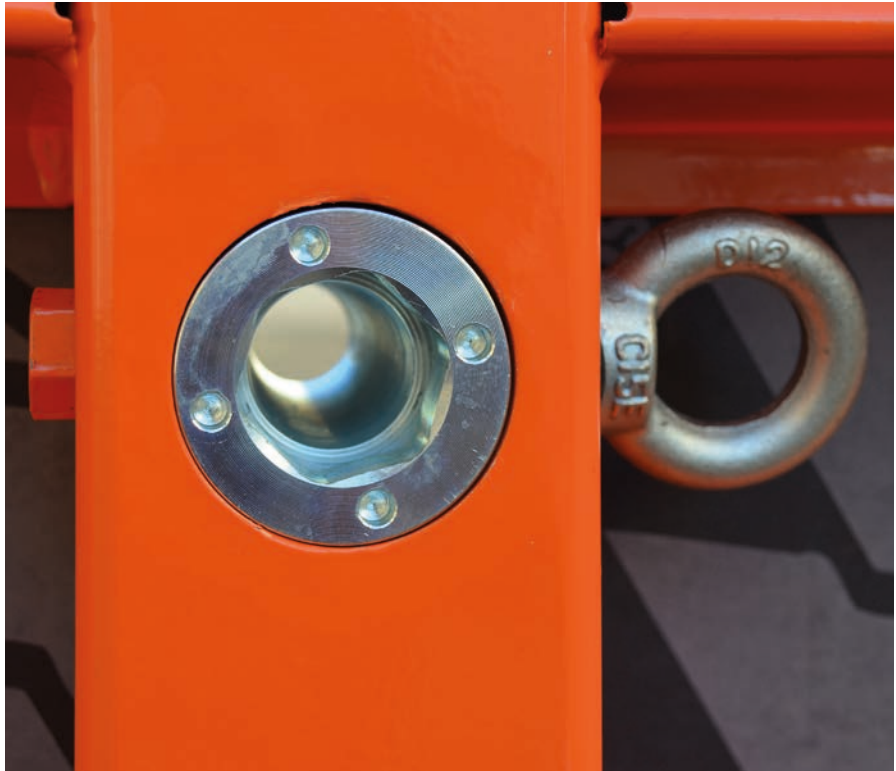

Guide bushing

### Smart changing system

The core elements of the new LOGO.pro are exchangeable steel bushings. The guide bushings inserted in the formwork are provided with a conical opening with a suitable diameter for DW15 or DW20 tie rods to be anchored from both sides in the classic way. For single-sided anchoring, the guide bushings on the outer formwork are replaced by clamping units. To do this, unlock the guide bushing with the assembly tool, unlock it by turning 90° on the ring bolt located next to the guide bushing, and pull it out.

Then the clamping unit with the integrated DW thread is inserted, secured and locked - finished. The inner and outer formwork can then be fitted as usual. Tie rod and tube are fed by the inner side and locked by the guide bushing.



Clamping unit



## No special parts required



Guide bushing and clamping unit

Unlike other manufacturers, PASCHAL does not rely on conical tie rods and complicated fitting methods. Instead, LOGO.pro uses conventional DYWIDAG tie rods. Accordingly, the PVC-tubes or fibreconcrete tubes can be freely selected as cladding tubes up to 50 mm diameter.

Compared to one-sided anchored formwork systems using conical anchors, the use of cost-effective standard components not only leads to simpler and thus faster work sequences, but also avoids potential problems that can arise in terms of material storage or loss of special parts. Thus LOGO.pro offers an advantage through simplicity and cost efficiency. It provides an economical alternative to the systems already available on the market.

## Compatibility with existing systems

The new LOGO.pro is convincing thanks to its universal compatibility with the PASCHAL formwork systems LOGO.3 and LOGO alu. All three systems are using the same connecting and accessory parts.

The new wall formwork consists of a profiled flat steel frame made of high-strength steel, and offers the same robustness and reliability as the already familiar LOGO.3 wall formwork. The admissible fresh concrete pressure is 70 kN/m<sup>2</sup>.



Installation height of just 12 cm, with the LOGO locking screw as a connecting piece

## Perfectly suitable for all floor plans

As usual with Paschal, the LOGO.pro formwork system, which can be operated from one side, also features a well-designed panel sorting system. The new formwork will initially be produced in the height 270 cm and the widths 240, 135, 90, 75, 60, 45, 30 cm. The system is completed with a rigid outside corner post 50x50 cm and the inside corner post 25x25 cm.

The tie points are positioned centrally on all compensation panels in order to achieve an orderly joint and anchor pattern with visually attractive concrete surfaces.



Perfect concrete surface



## Application

7



For single-sided anchoring, the tie rod together with the tube, the guide bushing and plate with ball-andsocket joint are turned into the clamping unit of the outer formwork.

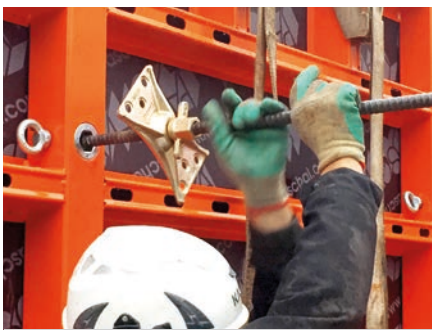

Unscrew the tie rod with the plate with ball-andsocket joint during dismantling.





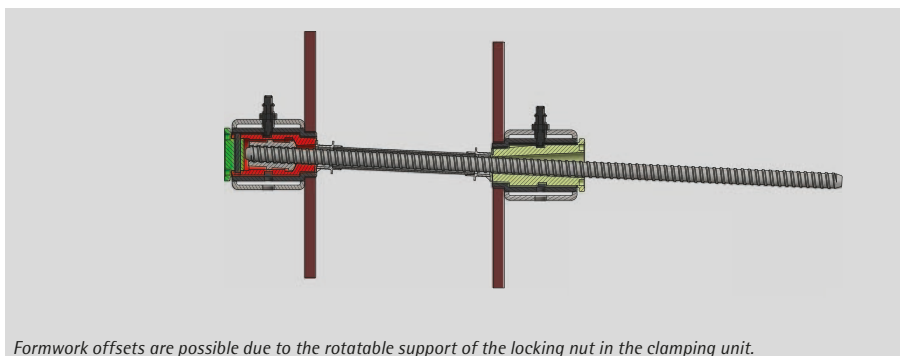



Clamping unit flush mounted in the panel frame

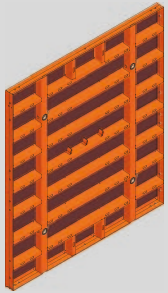

Formwork offsets are possible due to the rotatable support of the locking nut in the clamping unit.

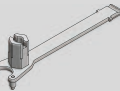
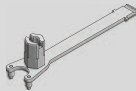
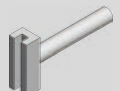
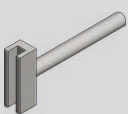
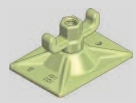

## Parts list

				Art.-N°	Item	kg		
	N176.501.2400	LOGO.pro panel incl. 4 guide bushing 240 x 270 cm	364,00	           <hr/> <p><i>Welding is not possible.</i></p> 	N187.500.0170	PRO guide bushing	1,63	PRO clamping unit DW15 mount. 1,89 DW20 mount. 1,75
		N176.501.1350	LOGO.pro panel incl. 4 guide bushing 135 x 270 cm		211,00	N187.500.0173	PRO assembly tool	
			N176.501.0900		LOGO.pro panel incl. 2 guide bushing 90 x 270 cm	141,00	N940.014.0165	Tie rod key DW15
	N176.501.0750		75 x 270 cm		130,00	N940.014.0171	Tie rod key DW20	1,42
	N176.501.0600		60 x 270 cm		96,50			
	N176.501.0450		45 x 270 cm		80,50	Tie rod DW15 x 85 cm 1,19 DW20 x 100 cm 2,55		
	N176.501.0300		30 x 270 cm		66,00			
		N176.506.0500	LOGO.pro outside corner post 50 x 50 x 270 cm		166,00	N189.001.0059	Plate with ball-and- socket joint DW15 10 x 14 cm inclin. max. 12°	1,29
			N176.505.0250		LOGO.pro inside corner post 25 x 25 x 270 cm	63,00	N189.001.0009	DW20 14 x 20 cm chrome coated

7

Subject to technical changes

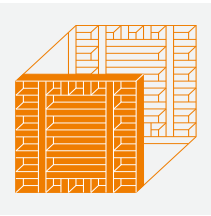

# LOGO.S

with steel facing





## LOGO.S with steel facing

The LOGO.S formwork system with a concrete pressure capacity of up to 100 kN/m<sup>2</sup> is fully compatible with all system components in the LOGO series which means it can be used universally. The formwork system comprises just a few panels which can be folded into a compact unit with a fixed platform bracket with a guard railing post, "Multip".

### Technical data

LOGO.S	
Max. concrete pressure	100 kN/m <sup>2</sup> according DIN 18218
Tolerances of deflection	According to DIN 18202, table 3, line 6
Panel widths	240 / 135 / 90 cm
Panel height	270 cm
Frame depth	35,5 (incl. folded platform)
Steel sheet	5 mm steel or magnetic stainless steel sheet
Frame	Profiled flat steel frame of high-strength steel

## LOGO.S with steel facing

Large-size system for residential and commercial buildings, industrial construction, civil engineering, reservoir construction.

- Panels with foldable, integrated working platforms and accessories  
→ time-saving during assembly
- Panel widths: 90cm, 135cm and 240cm (inside corner post and 5cm fillers to form corners and different wall thicknesses)
- Inside corner post 25 x 25 x 270 cm to form rectangular wall constructions
- Walls up to 265 cm height with only 0,3 ties/m<sup>2</sup> in concrete, due to tie point at edge of the panel frame
- No impressions of bolts or rivet heads  
→ perfect concrete finish
- Stepless height offset of panels is possible easily due to clamp connection
- Completely compatible with LOGO.3



Residential complex, F-Dorlisheim Fa. Boehm BTP, F-Molsheim

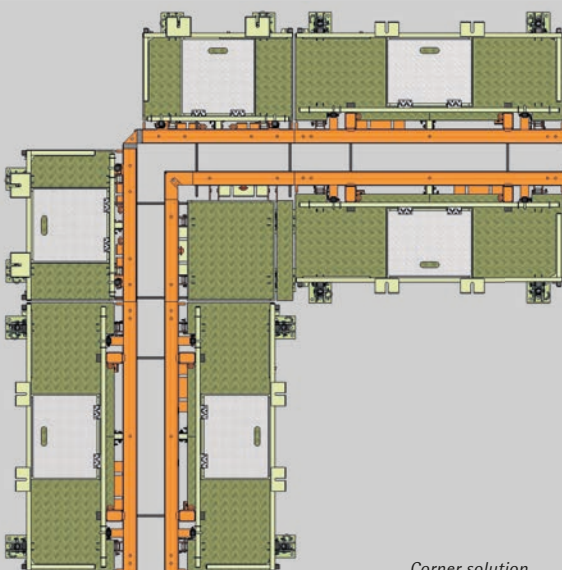

Corner solution

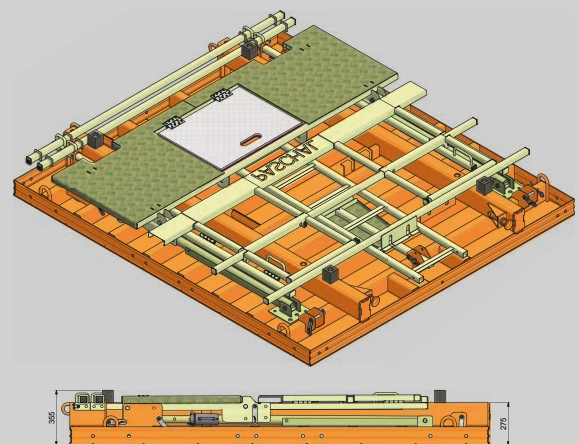

Folded together the panels are a compact unit with a fixed multi-functional working platform "Multipl".



## Parts list

	Art.-N°	Item	kg
	N176.101.2400	LOGO.S large-size panel 240x270cm incl. Multip	890,00
	N176.101.1350	LOGO.S multi-purpose panel 135x270cm incl. Multip	630,00
	N176.101.0900	LOGO.S panel 90x270cm incl. Multip	324,00
	N176.101.0600	60x270cm incl. Multip	230,00
	N176.101.0300	30x270cm incl. Multip	133,00
	N176.105.0250	LOGO.S inside corner 25x270cm	96,00
	N176.201.2400	LOGO.S large-size panel INOX 240x270cm incl. Multip	890,00
	N176.201.1350	LOGO.S multi-purpose panel INOX 135x270cm incl. Multip	630,00
	N176.201.0900	LOGO.S panel INOX 90x270cm incl. Multip	324,00
	N176.201.0600	60x270cm incl. Multip	230,00
	N176.201.0300	30x270cm incl. Multip	133,00
	N176.205.0250	LOGO.S inside corner INOX 25x270cm	96,00

Subject to technical changes





# TTR with plywood

## Trapezoidal Girder Formwork





## Technical data

Trapez TTR with plywood										
Max. concrete pressure	60 kN/m <sup>2</sup> according to DIN 18218									
Tolerances of deflection	According to DIN 18202, table 3, line 7									
Inside diameter	5,00 m – ∞ (inside)									
Segments	Inside	Height 300 cm · widths 230/222/115/57,5 cm								
	Inside	Height 150 cm · widths 230/222/115/57,5 cm								
	Inside	Height 75 cm · widths 230/222/115/57,5 cm								
	Inside	Height 37,5 cm · widths 230/222/115/57,5 cm								
Segments	Outside	Height 300 cm · widths 240/120/60 cm								
	Outside	Height 150 cm · widths 240/120/60 cm								
	Outside	Height 75 cm · widths 240/120/60 cm								
	Outside	Height 37,5 cm · widths 240/120/60 cm								
Plywood	15-ply, 21 mm thick (phenol resin coated)									
Inside diameter	2,00–5,00 m (inside)									
Segments	Inside	Height 300 cm · widths 110,5/55,5 cm								
	Inside	Height 150 cm · widths 110,5/55,5 cm								
	Inside	Height 75 cm · widths 110,5/55,5 cm								
	Inside	Height 37,5 cm · widths 110,5/55,5 cm								
Segments	Outside	Height 300 cm · widths 125,5/62,5 cm								
	Outside	Height 150 cm · widths 125,5/62,5 cm								
	Outside	Height 75 cm · widths 125,5/62,5 cm								
	Outside	Height 37,5 cm · widths 125,5/62,5 cm								
Plywood	14-ply, 18 mm thick									
Plastic filler piece	Widths 2/4 cm · Heights 37,5/75/150/300 cm									
Filler piece	Widths 6/8/10/12/14/16 cm									
	Heights 37,5/75/150/300 cm									
Filler plate	Adjustments for 3/5/7 cm · heights 37,5/75/150/300 cm									
Telescopic girder	Length 56,5/100 cm · for ramps									
Keybolt	Connecting piece	Oblong hole, segment connecting angle								
5-pin keybolt	Connecting piece	Plastic filler piece, filler plate								
Combi clamp	Connecting piece	Trapez-Modular/GE; Trapez-Logo								
Crane lifting eye KBT	max. safe working load 1700 kg									
Platform bracket	max. safe working load 2,0 kN/m <sup>2</sup>									
	Average bracket distance 1,20 m									
Tie rod	DW 15, max. safe working load 90 kN									
Tie spacing	Horizontal 1,20 m									
Formwork height=concreting height	m	1,50	2,25	3,00	3,75	4,50	5,25	6,00	6,75	7,50
Quantity of ties in concrete	Pieces/m <sup>2</sup>	0,55	0,37	0,28	0,44	0,37	0,47	0,41	0,49	0,44
Concrete haunch girder, variable	Reduction of ties in the concrete									
Concrete haunch girder, variable	Small	For widths 30–40 cm · for heights 50–70 cm								
	Big	For widths 30–60 cm · for heights 80–100 cm								

## The PASCHAL Trapezoidal Girder Formwork:

### Perfect all around

If you have to provide a perfect concrete result .....

..... or if you want to get by the result of your building site...

... or simply want to rule out any risks:

There's a formwork system which provides all the solutions:

The PASCHAL Trapezoidal Girder Formwork.

PASCHAL is the pioneer when manufacturing circular formworks with adjustable radius. Since the PASCHAL Trapezoidal Girder Formwork was launched on the market in 1975, PASCHAL's engineers have worked together with practical experts from building sites at continuous on-going developments to the convincing basic principle.

The result:

The PASCHAL Trapezoidal Girder Formwork is acknowledged to be the top product among all circular formwork systems with adjustable radii. All over the world.

Your advantage:

Massive cost savings on your building sites and safety from incalculable risks.

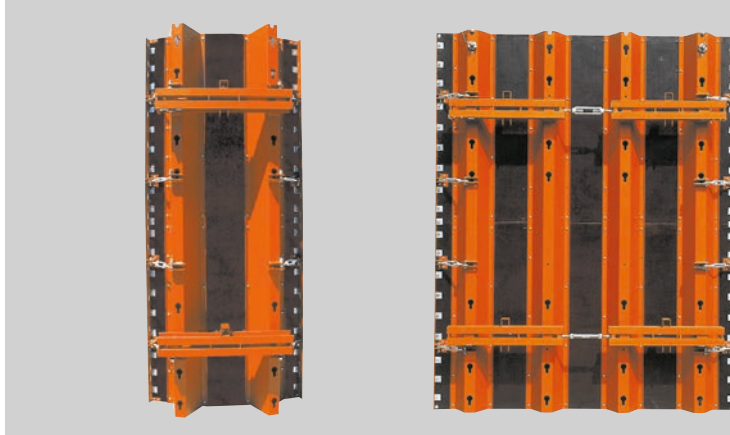

Sewage plant, D-Forchheim; Ed. Züblin AG, Direktion Karlsruhe



## The system with many unique advantages:

### Advantage 1: Extreme adjusting range from $r=\infty$ to $r=2,50\text{ m}$ or $r=1,00\text{ m}$

Version:  $\varnothing 5,00\text{ m}-\infty$

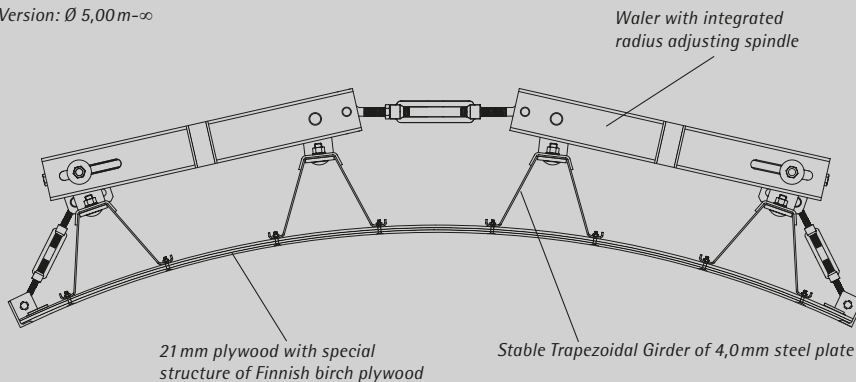

The PASCHAL Trapezoidal Girder Formwork is available in two versions:

- for inside diameter 5,00 m ( $r = 2,50\text{ m}$ ) to infinite (straight)
- for inside diameter 2,00 m ( $r=1,00\text{ m}$ ) to inside diameter 5,00 m

9

Together with the superior support construction of trapezoidal steel plate girders with clever geometry, these extreme adjusting ranges are made possible particularly by specially developed plywood structures.

Version:  $\varnothing 2,00 - 5,00\text{ m}$

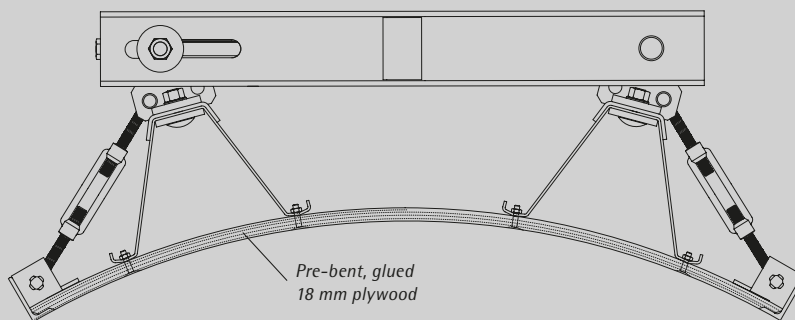

PASCHAL has worked together with an efficient Finnish manufacturer to optimize the special structure of the 21 mm birch plywood in such a way that the radius can be perfectly adjusted for diameters of up to 5,00 m ( $r=2,50\text{ m}$ ). No other system on the market can survive this without damage.

Your advantage:

You only need one single system to form all diameters right down to 5,00 m.

This means keeping less material in store and less transport charges!

The version 2,00 - 5,00 m covers all small diameters right down to the narrowest staircase or, for example, pivot bearings in sewage tanks. Pre-bent, glued 18 mm plywood is prerequisite for this high flexibility which is not detrimental to the stability of the system. Here too the radius can be adjusted quickly and simply without time-consuming removing or refitting of any supplementary plates.

The version 2,00 - 5,00 m is ideal for forming pivot bearings in sewage plants.



Water tank, D-Oberhausen; Uhrig

## Advantage 2: Absolutely round and accurate dimensions

The PASCHAL Trapezoidal Girder Formwork has a superior design for perfect, reliable roundness and dimensional accuracy – even for narrow radii!



Fresh water tank, Algeria; Chiali SERVICES Spa, Algeria

9

## Superior support for the plywood

Your advantage:

No polygonal corrugations in the plywood for narrow radii.

This ideal plywood support is not possible when using other girders, for example wooden girders tied in pairs.

- Optimized support intervals thanks to the ideal geometry of the Trapezoidal Girders.
- No impairment to the round shape even between the Trapezoidal Girder feet (a).
- The Trapezoidal Girder reacts elastically to changes in the length of the plywood surface when adjusting the radius (b).
- Perfection in detail: Trapezoidal Girder feet support the plywood on a uniform line for all adjusted radii. This means there is no shifting of the support lines and no flat support which would impair the round shape.

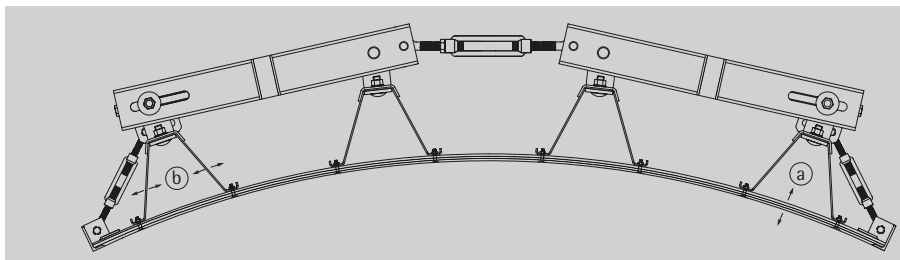

## The perfect connection between segments

The perfect tightness and roundness at the joint of the segments is not guaranteed for higher frames and clamp connections, particularly not for small radii.

- The PASCHAL segment connection angle encloses the plywood and guarantees full, introduction of the high forces which have to be transmitted when adjusting narrow radii and this without damage (c).
- The radius adjusting turnbuckles can be fastened very close to the plywood (d). This avoids the tendency of higher frames to tilt and tear.
- The PASCHAL keybolt completely rules out any risk of mismatching at the joints, and guarantees the necessary tightness of the structure (e). In this way you can avoid expensive reworking at the joints!
- Oblong holes also allow for height adjustment between the segments. Uneven areas in the ground plate can be compensated for without any problems.

Keybolt connection for an unsurpassed tight, offset-free connection, even for small radii!

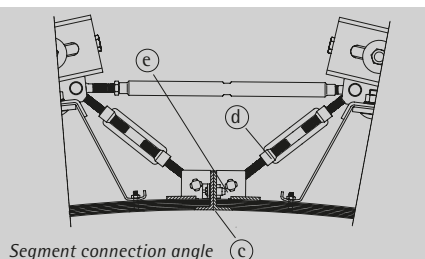

Segment connection angle (c)

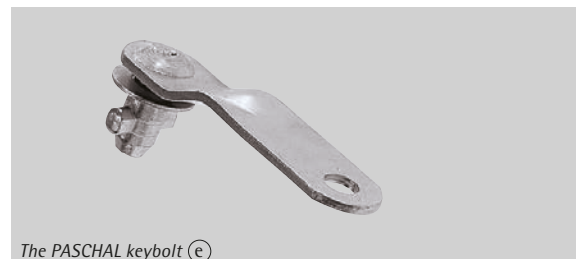

The PASCHAL keybolt (e)



### Advantage 3: Extremely low number of ties in the concrete

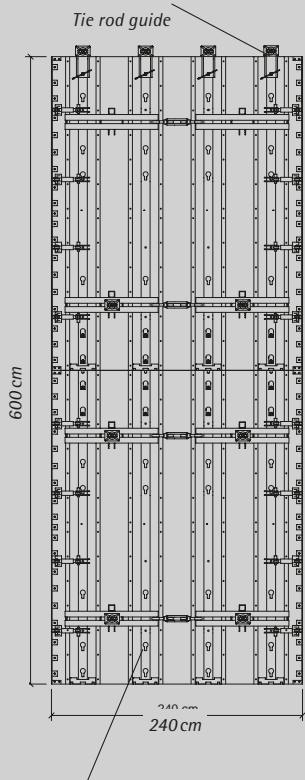

Water with integrated radius adjusting spindle

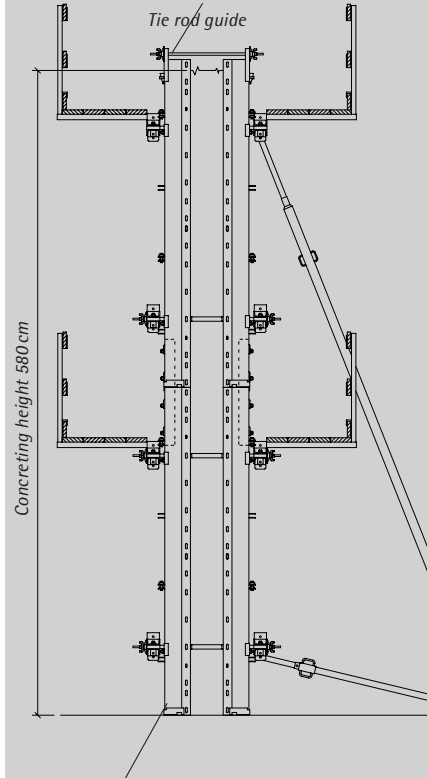

Segment 240x300 cm,  
with extension segment 240x300 cm

Ties (anchor points) cost money. Lots of money, particularly when making watertight concrete which might even include water barriers. PASCHAL Trapezoidal Girder Formwork helps you to save on the number of ties, and thus to save money.

Thanks to the robust construction of the 4 mm thick steel plate Trapezoidal Girders, this formwork system can provide with an extremely low number of ties.

In the principal segment format 240x300 cm (= 7,20 m<sup>2</sup>), 4 ties are sufficient = 0,56 ties/m<sup>2</sup>!

If the 300 cm high segment is not extended any further, then you can place the top tie over the top edge of the concrete using the tie rod guide = even fewer expensive ties in the concrete = 0,28 ties/m<sup>2</sup>!

Important:

In spite of this low number of ties, the maximum load-carrying capacity of concrete pressure of 60 kN/m<sup>2</sup> is maintained fully for all segments and all formwork heights in compliance with the tolerances of deflection as per DIN 18202, table 3, line 7!



Biogas plant, D-Bürstadt; Wilms, D-Bürstadt

Here a tie was placed over the upper segment using the tie rod guide, so that for a concreting height of 8,50m, only 5 ties were required in the concrete. (0,5 ties/m<sup>2</sup>)

## Advantage 4: Unique offer of segment dimensions

If closed circles are to be formed in one phase then it is important to have a suitable range of narrower standard widths so that there is no need for special widths for each specific building, or for complicated closure of the circle on site.

It is not a good idea for the formwork segments to overlap too much in height. It makes it more difficult to bring the concrete exactly to the required level and to finish the surface (e.g. scraping or smoothing). This also unnecessarily increases the material you need to keep on site, together with transport weights and volumes.

You will find that PASCHAL offers an ideal range of segment heights so that you can always reach a practical formwork height.



Sewage plant, D-Forchheim; Ed. Züblin AG, Direktion Karlsruhe

### Available widths [cm]:

Segments Ø 2,00 - 5,00 m		Segments from Ø 5,00 m	
Inside segment	Outside segment	Inside segment	Outside segment
		230/222	240
110,5	125	115	120
55,5	62,5	57,5	60

### Available heights:

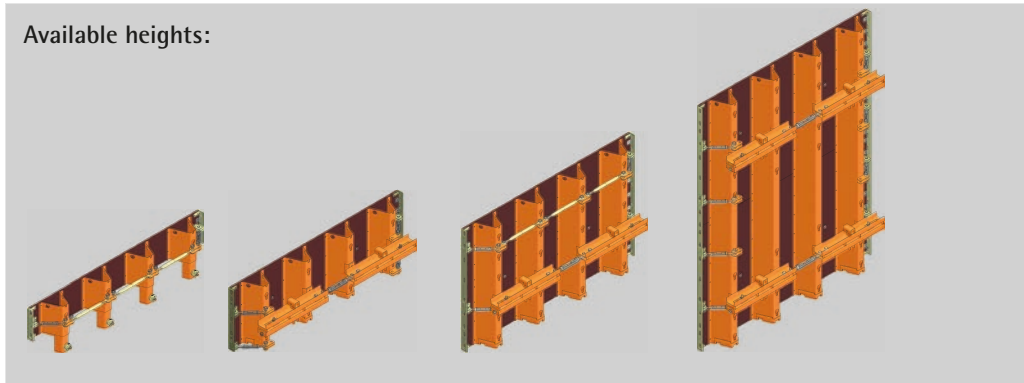

## Advantage 5: Variable gradient compensation with the telescopic girder

The increasing lack of parking space in our cities means that more and more buildings have to be provided with underground car parks. Often the entrance walls are of round shape. Here the formwork costs can quickly get out of control. PASCHAL offers the ideal system solution: The Trapezoidal Girder Formwork with telescopic girder

The telescopic girders are fully variable in extension and can be pushed into the Trapezoidal Girders from the top and bottom. Lengths: 56,5 cm and 100 cm.

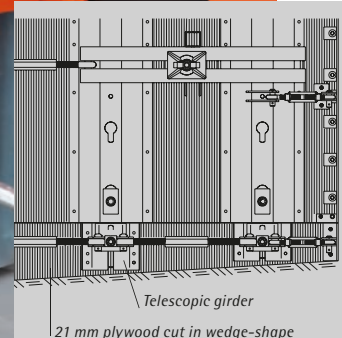
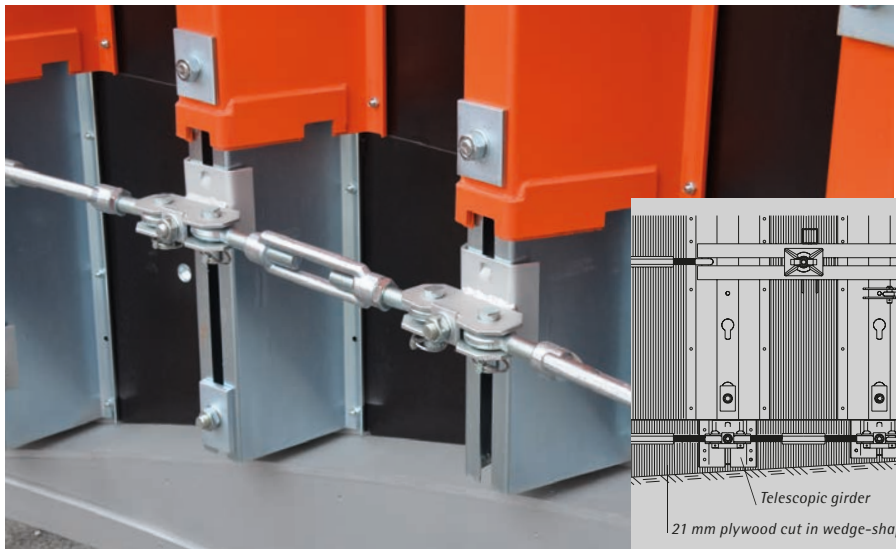



## Advantage 6: No length filler pieces on site



Gastronomic silo with a panorama platform, CH-Einsiedeln; Föllmi AG, CH-Feusisberg

Whenever you hear the circular saw on your building sites, this should always make you think of your forming costs: frequently it will be used for cutting pieces on site, which are needed when using inexpensively rented or bought formworks. But this ruins your forming times.

Using the saw prevents rapid, systematic forming!

And circular formworks frequently need lots of length adjustments.

It is difficult to account for the resulting costs, in contrast to rental costs. But they can be very significant for the profit on a building site.

PASCHAL Trapezoidal Girder Formwork helps you to rule out such incalculable costs from the very start. You do not need expensive length adjustments on site, but you get a complete formwork which lets you close every last centimetre. Quickly, reliably, systematically!

And there are two more positive aspects:

- You can rent all the above mentioned filler pieces.
- The fillers are held by the PASCHAL key-bolts when erecting the formwork and cannot fall "into the wall".



Sewage plant, D-Seesen; Bauunternehmung WBB Bau & Beton GmbH, D-Umpferstedt

These are the "forming time accelerators" for PASCHAL Trapezoidal Girder Formwork:

**Steel filler piece**  
Widths: 6, 8, 10, 12, 14, 16 cm  
Heights: as segments

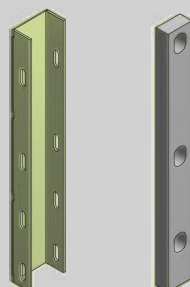

**Plastic filler piece (PE)**

Made of environment-friendly, low-compression polyethylene. Unbreakable, durable, easy to clean, no deformation or twisting.

Widths: 2 cm, 4 cm  
Heights: as segments

## Advantage 7: Robust extension and particularly high-load carrying crane lifting clamp capacity

Nothing will happen...

...if your crane raises or lowers an extended section of 9 metres made up of PASCHAL Trapezoidal Girder Formwork segments without additional vertical bracing at the horizontal joints!

The Trapezoidal Girder extension post is screwed with the steel Trapezoidal Girders over the joint. The connection is so rigid that even 10,5m high formwork units can be raised or lowered by crane without needing additional walers.

Your advantage: formwork erection and dismantling very high walls is made much easier and faster.

The crane lifting eye KBT has a load-carrying capacity of 1700 kg. It can be fastened very easily to a Trapezoidal Girder. Thanks to the robust design of the Trapezoidal Girders made of 4 mm steel plate, there is no risk of the structure tearing.

With only 2 crane lifting eyes KBT you can move complete formwork units of up to 40 m<sup>2</sup>.

Your advantage:  
Record times in step-by-step formwork operations!



Crane lifting eye KBT



Trapezoidal Girder extension post



For large formwork heights (9,75 m here) and step-by-step forming operations, the robust extension pieces and the crane lifting eye with its particularly high load-carrying capacity achieve record forming times.



Biogas plant, D-Laar; G. Büter Bauunternehmen GmbH & Co. KG, D-Ringe



## Advantage 8: Variable haunch girders as rented system solution



Sewage plant, D-Forchheim; Ed. Züblin AG, Direktion Karlsruhe

If concrete haunches cannot be subsequently added when building circular tanks but have to be included in the formwork procedure, you will find that PASCHAL offers a technically outstanding system solution: variable haunch girders for forming all conventional haunch dimensions.

Only the plywood for haunch formwork has to be cut and assembled specially. On request you can receive the segments with the haunch formwork ready for forming from PASCHAL.

9



*The photo shows the extremely solid structure of the variable haunch girders. They are screwed to the Trapezoidal Girders. Important: the lift safeguard at the bottom of the haunch girders. Proper plugging to the ground plate is absolutely indispensable!*

## Advantage 9: Top forming times

With PASCHAL Trapezoidal Girder Formwork you can achieve top forming times.

Some of the main reasons for this have already been explained on the previous pages.

- The dimensional accuracy of the Trapezoidal Girder Formwork segments dispenses any subsequent adjustment of the fixed diameter after transport to the building site and between concreting pours.
- The extremely low number of ties in the concrete, which reduces setting times and reduces the need for closing the ties later on.
- The omission of the time-consuming on-site production of filler pieces.
- The possibility of moving very high and very large formwork units in closed form.

But this is not all.

There are other important advantages in PASCHAL Trapezoidal Girder Formwork which helps you to save further costs through top forming times:

- Extending and rounding segments is very easy, precise and fast.
- You can also order the segments ready extended and rounded straight from PASCHAL, and erect the units directly from the low loader truck.
- You can return the segments extended and rounded to PASCHAL after their last use.
- You do not have to mount walers (distribution bars etc.) before first use and dismantle them before return delivery.

In using Trapezoidal Girder Formwork, you can easily achieve better forming times than with large-size formwork for straight walls.

Re-spindling the segments to another radius is quick and easy. Even on the building site. With PASCHAL Trapezoidal Girder Formwork, projects are often completed much earlier than planned. In this way it is also possible to reduce the calculated rental costs.



## Application

### Tank construction

Whether circular or oval sewage tanks, rain overflow tanks, drinking water tanks, silos,...

...with PASCHAL Trapezoidal Girder Formwork, systematic better.

When building sewage tanks, dimensional accuracy of the concrete surface and the (low) number of ties is of particular importance.



Residual water plant, D-Perl; OBG AG

### Circular walls for structural engineering projects

When walls, staircases or elevator shafts have to be absolutely round, then PASCHAL Trapezoidal Girder Formwork is the top favourite.



Parzival school, D- Karlsruhe; Weisenburger Bau GmbH

Have you already seen it?



In our application video we present all product highlights of the Trapezoidal Girder Formwork. It's worth taking a look!





White water park „Île de Loisirs de Vaires-Torcy“, F-Paris; CHARIER GC

## Swimming baths and pools

“Wildly” changing large and small radii, frequently interspersed with corners and these not always at 90°: a real formwork challenge, which you can master easily using PASCHAL Trapezoidal Girder Formwork, possibly combined with PASCHAL Modular Formwork!

The constantly changing radii in the pools of modern adventure swimming baths can be adjusted simply and precisely on the building site. The staff quickly “get the hang of it” even without prior experience. You can also request a PASCHAL fitter to give instructions.

Keeps you cool when dealing with the hot curves in thermal baths:  
PASCHAL Trapezoidal Girder Formwork.



White water park „Île de Loisirs de Vaires-Torcy“, F-Paris; CHARIER GC



Entertainment spa Titisee Neustadt; Constructor Hermann GmbH, D-Furtwangen



## Non-circular curves and tapers

Even non-circular layouts such as ellipses or freely defined curves can be adjusted precisely.

9

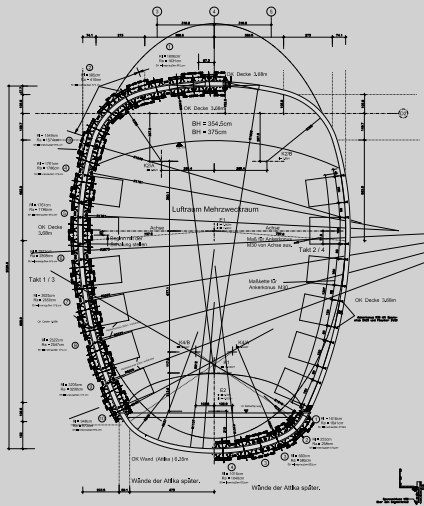

freely defined curve layout



Multipurpose room Erich Kästner School, D-Lich; OTTO HEIL GmbH & Co KG, D-Oerlenbach – Eltingshausen



Subway, F-Paris; EIFFAGE TP, F-Paris

## Tunnels

For shorter tunnels, the use of special steel tunnel formwork is not economical.

Here PASCHAL offers a rental and thus low-cost system solution consisting of Trapezoidal Girder Formwork and aluminium shoring system. Whether small or large, whether circular or other curved cross sections, the Trapezoidal Girder Formwork can be used to create any vaulted form.

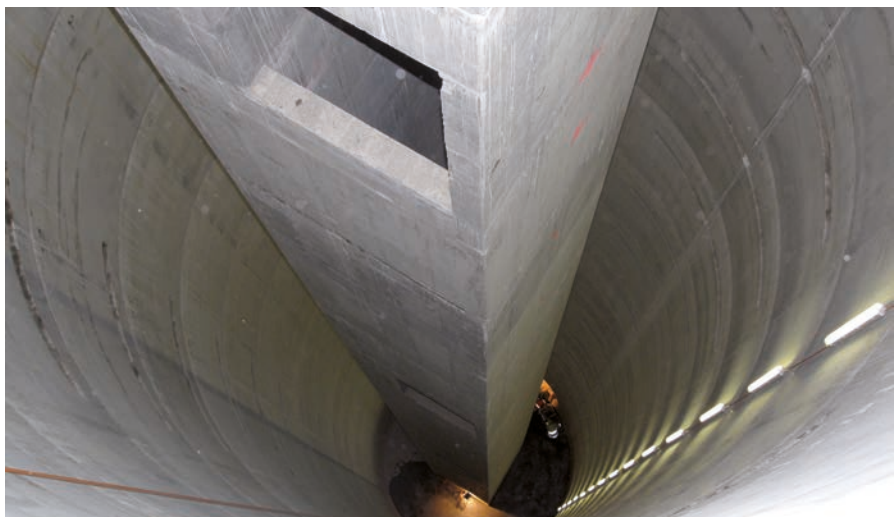

Subway, A - Vienna; STRABAG SE



## Parts list

	Art.-N°	Item	kg		Art.-N°	Item	kg	
		Segments for inside diameter from 5,00 m				Segments for inside diameter from 5,00 m		
		Basic segment outside					Basic segment outside	
	N122.101.0222	240x300cm	540,00		N122.101.0239	240x75 cm	168,00	
	N122.101.0233	120x300cm	286,00		N122.101.0237	120x75 cm	90,00	
	N122.100.0241	60x300cm	135,00		N122.100.0247	60x75 cm	45,30	
		Basic segment inside				Basic segment inside		
	N122.101.0122	230x300cm	524,00		N122.101.0139	230x75 cm	162,00	
	N122.101.0022	222x300cm	521,00		N122.101.0039	222x75 cm	161,00	
	N122.101.0133	115x300cm	280,00		N122.101.0137	115x75 cm	87,00	
	N122.100.0141	57,5x300cm	134,00		N122.100.0147	57,5x75 cm	37,00	
		Segments for inside diameter from 2,00 – 5,00 m				Segments for inside diameter from 2,00 – 5,00 m		
		Basic segment outside				Basic segment outside		
N122.112.0001	125,5x300cm	303,00	N122.112.0009	125,5x75 cm	90,00			
N122.112.0003	62,5x300cm	134,00	N122.112.0021	62,5x75 cm	41,00			
	Basic segment inside			Basic segment inside				
N122.112.0011	110,5x300cm	279,00	N122.112.0019	110,5x75 cm	88,00			
N122.112.0013	55,5x300cm	130,00	N122.112.0031	55,5x75 cm	40,00			
		Segments for inside diameter from 5,00 m				Segments for inside diameter from 5,00 m		
		Basic segment outside					Basic segment outside	
	N122.101.0231	240x150cm	297,00		N122.100.0232	240x37,5 cm	90,00	
	N122.101.0236	120x150cm	159,00		N122.100.0240	120x37,5 cm	47,00	
	N122.100.0246	60x150cm	67,50		N122.100.0245	60x37,5 cm	26,00	
		Basic segment inside				Basic segment inside		
	N122.101.0131	230x150cm	290,00		N122.100.0132	230x37,5 cm	88,00	
	N122.101.0031	222x150cm	288,00		N122.100.0032	222x37,5 cm	87,50	
	N122.101.0136	115x150cm	156,00		N122.100.0140	115x37,5 cm	47,00	
	N122.100.0146	57,5x150cm	64,50		N122.100.0145	57,5x37,5 cm	26,00	
		Segments for inside diameter from 2,00 – 5,00 m				Segments for inside diameter from 2,00 – 5,00 m		
		Basic segment outside				Basic segment outside		
	N122.112.0006	125,5x150cm	156,00		N122.112.0034	125,5x37,5 cm	52,50	
	N122.112.0020	62,5x150cm	50,00		N122.112.0035	62,5x37,5 cm	27,00	
		Basic segment inside				Basic segment inside		
	N122.112.0016	110,5x150cm	139,00		N122.112.0036	110,5x37,5 cm	46,50	
	N122.112.0030	55,5x150cm	48,00		N122.112.0037	55,5x37,5 cm	25,00	

Subject to technical changes

Parts list











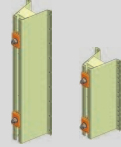

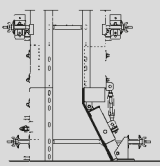



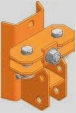

	Art.-N°	Item	kg
	N189.001.0100	Keybolt	0,19
	N189.001.0105	5 pin keybolt	0,30
	N282.000.0202	Keybolt 0-2-4 cm	0,24
	N282.000.0203	Assembly clamp 0-2-4 cm	2,70
	N182.000.0210	Turnbuckle M 20 with lock nut M20 320 - 470 mm	1,60
	N182.000.0211	450 - 600 mm	2,10
	N182.000.0212	600 - 750 mm	2,70
	N182.000.0213	750 - 900 mm	3,30
 <i>Welding is not possible.</i>	N189.006.1000	Tie rod, bevelled DW 15 x 100 cm	1,40
	N189.006.1350	DW 15 x 135 cm	1,85
	N189.006.1500	DW 15 x 150 cm	2,10
	N189.001.0059	Plate with ball-and-socket joint DW 15, 10 x 14 cm (inclination max. 12°)	1,12
	N189.001.0020	Spacer strap 6 - 50 cm	1,50
	N189.001.0021	Spacer strap 50 - 120 cm	3,50
	N182.000.0132	Plastic filler piece 2 x 37,5 cm	0,50
	N182.000.0162	4 x 37,5 cm	1,00
	N182.000.0129	2 x 75 cm	1,00
	N182.000.0131	4 x 75 cm	2,00
	N182.000.0125	2 x 150 cm	2,00
	N182.000.0127	4 x 150 cm	4,00
	N182.000.0121	2 x 300 cm	4,00
	N182.000.0123	4 x 300 cm	8,00

	Art.-N°	Item	kg
		TTR Filler piece	
	N182.000.0185	6 x 37,5 cm	2,40
	N182.000.0186	8 x 37,5 cm	2,50
	N182.000.0187	10 x 37,5 cm	2,70
	N182.000.0188	12 x 37,5 cm	2,80
	N182.000.0189	14 x 37,5 cm	2,90
	N182.000.0193	16 x 37,5 cm	3,00
	N182.000.0141	6 x 75 cm	4,90
	N182.000.0142	8 x 75 cm	5,05
	N182.000.0143	10 x 75 cm	5,40
	N182.000.0144	12 x 75 cm	5,60
	N182.000.0145	14 x 75 cm	5,90
	N182.000.0146	16 x 75 cm	6,05
	N182.000.0115	6 x 150 cm	9,90
	N182.000.0108	8 x 150 cm	10,20
	N182.000.0107	10 x 150 cm	10,80
	N182.000.0137	12 x 150 cm	11,20
	N182.000.0138	14 x 150 cm	11,70
	N182.000.0106	16 x 150 cm	12,05
	N182.000.0114	6 x 300 cm	19,00
	N182.000.0111	8 x 300 cm	20,00
	N182.000.0110	10 x 300 cm	21,50
N182.000.0139	12 x 300 cm	22,40	
N182.000.0140	14 x 300 cm	23,50	
N182.000.0109	16 x 300 cm	24,50	
		Filler plate without opening for ties (for compensations of 3/5/7 cm)	
	N182.000.0273	8 x 37,5 cm	1,80
	N182.000.0147	8 x 75 cm	3,60
	N182.000.0148	8 x 150 cm	7,20
N182.000.0149	8 x 300 cm	15,60	
	N182.000.0089	Tie rod guide with wedge T	2,56
	N182.000.0223	Tie rod guide with crane lifting eye	7,80
	N182.000.0224	Tie rod guide without crane lifting eye	6,80
	N182.000.0263	Tie rod guide for segment height 37,5 cm TR/TK	2,40

Subject to technical changes

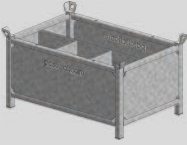

## Parts list

	Art.-N°	Item	kg		Art.-N°	Item	kg
	N182.000.0069	Crane lifting eye KBT Admissible capacity 1.700 kg TR/TK	5,77		N182.000.0099	Telescopic girder cpl. TR/TK 100 cm	18,00
	N182.000.0053	Platform bracket 90 cm cpl. for Trapezoidal girder formw.	11,10		N182.000.0100	56,5 cm	13,00
	N182.000.0133	Platform bracket fastening Trapezoidal girder top mounted	5,50		N189.003.0000	Assembly tool N/TR/R	3,90
	N182.000.0009	Extension post for Trapez. girders cpl.	17,00		N182.000.0093	Ratchet key SW30	1,51
	N282.000.0085	Extension post Trapez. girder cpl. reinforced	20,00		N182.000.0215	Multiple key SW36/27-SW30/24 chromate coated	1,40
	N182.000.0055	Turnbuckle coupler 2-holes cpl.	5,40		N182.000.0179	Centering tool N/TR/R	0,67
	N182.000.0032	Stop end guide cpl.	2,90		N182.000.0283	Cover for trapezoidal girder T	0,18
	N189.001.0118	Double channel waler U 60 length 80 cm	8,20		N182.000.0063	Template for radius adjustment on site	2,00
	N182.000.0284	Segment guide with wedge	2,50		N182.000.0116	Template for Trapezoidal girder segments d.2.0-5.0m	2,00
	N182.000.0219	Jackscrew for Trapezoidal capacity 1500 kg	2,90		N189.002.0003	Transportation box hot-dip galvanized 120 x 80 x 61 cm	86,50
	N182.000.0096	Suspending piece for props Trapezoidal girder	3,00		N940.009.0019	Cover lattice box/ transp. 1100 x 680 x 35 mm	6,70

Subject to technical changes



# TTK with clamp connection

## Circular Trapezoidal Girder Formwork





## TTK Circular Trapezoidal Girder Formwork with clamp connection



Biogas plant, D-Meppen; Baugeschäft H. Wösten GmbH, D-Haren-Altenberg

The Circular formwork with new connection method.

Advantages of clamp connection:

- Less connecting pieces
- Fast segment connection
- Clamps can be "stored" at the segment
- Stepless segment positioning with height offset

10







Biogas plant, D-Meppen; Baugeschäft H. Wösten GmbH, D-Haren-Altenberg

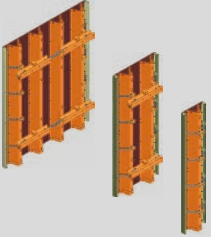

The clamps are „stored“ at the segment during dismantling. For casting next phase they are already at the right place.

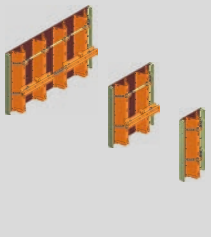
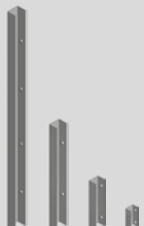
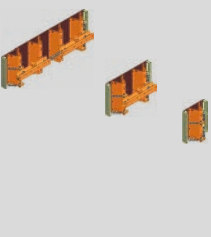
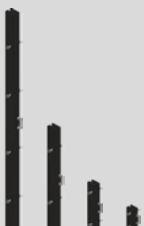
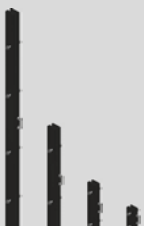
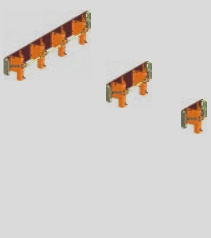
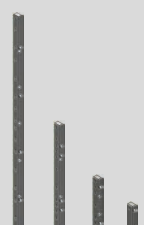
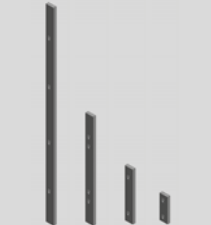























## Parts list

	Art.-N°	Item	kg		Art.-N°	Item	kg		
		<b>TTK segment outside</b>			N182.008.0024	2 x 150 cm	3,40		
	N122.108.0222	240 x 300 cm	593,00		N182.008.0025	4 x 150 cm	6,80		
	N122.108.0233	120 x 300 cm	340,00		N182.008.0026	6 x 150 cm	10,20		
	N122.108.0241	60 x 300 cm	170,50		N182.008.0027	2 x 75 cm	1,70		
		<b>TTK segment inside</b>			N182.008.0028	4 x 75 cm	3,40		
	N122.108.0122	230 x 300 cm	577,00		N182.008.0029	6 x 75 cm	5,10		
	N122.108.0022	222 x 300 cm	573,00		N182.008.0030	2 x 37,5 cm	0,85		
	N122.108.0133	115 x 300 cm	331,00		N182.008.0031	4 x 37,5 cm	1,70		
	N122.108.0141	57,5 x 300 cm	169,50		N182.008.0032	6 x 37,5 cm	2,55		
			<b>TTK segment outside</b>					<b>TTK filler piece</b>	
		N122.108.0231	240 x 150 cm		308,00		N182.008.0040	12x300cm	39,80
		N122.108.0236	120 x 150 cm		174,00		N182.008.0041	14x300cm	40,80
N122.108.0246		60 x 150 cm	86,00	N182.008.0042	16x300cm		41,80		
		<b>TTK segment inside</b>		N182.008.0044	12x150cm		19,90		
N122.108.0131		230 x 150 cm	299,00	N182.008.0045	14x150cm		20,40		
N122.108.0031		222 x 150 cm	297,00	N182.008.0046	16x150cm		20,90		
N122.108.0136		115 x 150 cm	169,30	N182.008.0048	12x75cm		10,20		
N122.108.0146	57,5 x 150 cm	85,60	N182.008.0049	14x75cm	10,40				
		<b>TTK segment outside</b>			N182.008.0050	16x75cm	10,60		
	N122.108.0239	240 x 75 cm	192,00		N182.008.0052	12x37,5cm	5,30		
	N122.108.0237	120 x 75 cm	107,60		N182.008.0053	14x37,5cm	5,40		
	N122.108.0247	60 x 75 cm	45,50		N182.008.0054	16x37,5cm	5,50		
		<b>TTK segment inside</b>					<b>TTK dismantling wedge</b>		
	N122.108.0139	230 x 75 cm	184,50			N182.008.0034	6x300cm	24,00	
N122.108.0039	222 x 75 cm	184,00	N182.008.0035	6x150cm		12,00			
N122.108.0137	115 x 75 cm	103,80	N182.008.0036	6x75cm		6,00			
N122.108.0147	57,5 x 75 cm	45,20	N182.008.0037	6x37,5cm		3,00			
		<b>TTK segment outside</b>					<b>TTK connecting panel to TTR cpl.</b>		
	N122.108.0232	240x37,5 cm	86,40		N182.008.0010	6x300 cm	31,80		
	N122.108.0240	120x37,5 cm	47,80		N182.008.0011	6x150 cm	16,30		
	N122.108.0245	60x37,5 cm	28,00		N182.008.0012	6x75 cm	8,50		
		<b>TTK segment inside</b>			N182.008.0013	6x37,5 cm	4,50		
	N122.108.0132	230 x 37,5 cm	85,90						
	N122.108.0032	222 x 37,5 cm	86,00		N182.008.0001	Multi clamp TTK 0-10 cm	4,40		
	N122.108.0140	115 x 37,5 cm	47,50						
N122.108.0145	57,5 x 37,5 cm	28,00	N182.008.0002	TTK bolt for stop end cpl.	0,83				
		<b>TTK plastic filler incl. fastening parts</b>			N182.008.0003	TTK bolt for segment cpl.	0,88		
	N182.008.0021	2 x 300 cm	6,90						
	N182.008.0022	4 x 300 cm	13,80						
	N182.008.0023	6 x 300 cm	20,50						

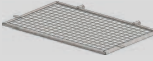
Subject to technical changes



## Parts list

	Art.-N°	Item	kg		Art.-N°	Item	kg
	N182.008.0004	TTK bolt for connecting panel galvanised	0,32		N182.000.0133	Platform bracket fastening Trapezoidal girder top mounted	5,50
	N182.008.0005	TTK bolt DW15x150 galvanised	0,41		N182.000.0009	Extension post for Trapez. girders cpl.	17,00
	N182.008.0006	TTK washer galvanised	0,12		N282.000.0085	Extension post Trapez girder cpl. reinforced	20,00
	N189.001.0002	Hexagon nut DW15	0,20		N182.000.0055	Turnbuckle coupler 2-holes cpl.	5,40
		Turnbuckle M20 with lock nut M20			N182.000.0032	Stop-end guide cpl.	2,90
	N182.000.0210	320 - 470 mm	1,60		N189.001.0118	Double channel waler U 60 length 80 cm	8,20
	N182.000.0211	450 - 600 mm	2,10		N182.000.0284	Segment guide with wedge	2,50
	N182.000.0212	600 - 750 mm	2,70		N182.000.0219	Jackscrew for Trapezoidal capacity 1500 kg	2,90
		750 - 900 mm	3,30		N182.000.0096	Suspending piece for props Trapezoidal girder	3,00
<i>Welding is not possible.</i>		Tie rod			N182.000.0093	Ratchet key SW30	1,51
	N189.006.1000	DW 15 x 100 cm	1,40		N182.000.0215	Multiple key SW36/27-SW30/24 T	1,40
	N189.006.1350	DW 15 x 135 cm	1,85		N182.000.0179	Centering tool N/TR/R	0,80
N189.006.1500	DW 15 x 150 cm	2,10		N189.002.0003	Transportation box hot-dip galvanized 1200 x 800 x 610 mm	86,50	
	N189.001.0059	Plate with ball-and-socket joint DW 15, 10x14cm inclin. max. 12°	1,29		N940.009.0019	Cover lattice box/transp. 1100 x 680 x 35 mm	6,70
	N182.000.0089	Tie rod guide with wedge T	2,56				
	N182.000.0223	Tie rod guide with crane lifting eye	7,80				
	N182.000.0224	Tie rod guide without crane lifting eye	6,80				
	N182.000.0263	Tie rod guide for segment height 37,5 cm TR/TK	2,40				
	N182.000.0069	Crane lifting eye KBT capacity 1.700 kg TR/TK	5,77				
	N182.000.0053	Platform bracket 90 cm cpl. for Trapezoidal girder formw.	11,10				

10

Subject to technical changes



# TTS with steel face

Trapezoidal Girder Formwork





## Technical data

Trapez TTS with steel face										
Max. concrete pressure		80 kN/m <sup>2</sup> according to DIN 18218								
Tolerances of deflection		According to DIN 18202, table 3, line 7								
Diameter range		5,00 m – ∞ (inside)								
Segments	Inside	Height 300 cm · widths 230/115/57,5 cm								
	Inside	Height 150 cm · widths 230/115/57,5 cm								
	Inside	Height 75 cm · widths 230/115/57,5 cm								
Segments	Outside	Height 300 cm · widths 240/120/60 cm								
	Outside	Height 150 cm · widths 240/120/60 cm								
	Outside	Height 75 cm · widths 240/120/60 cm								
Face		Steel face								
Timber fillers		Widths 2/4//6 cm								
		Heights 75/150/300 cm								
Filler plate		Widths 8/10/12/14/16 cm								
		Heights 75/150/300 cm								
GE/TTS clamp	Connecting piece	Segments without fillers								
Adjustable GE/TTS clamp	Connecting piece	Segments with fillers up to 5 cm								
Lockingscrew DW 15	Connecting piece	Segments without fillers								
Filler screw DW 15	Connecting piece	Segments with filler plate from 8 to 16 cm								
Integrated crane lifting eye		Allowable lifting load 2000 kg/eye								
Platform bracket		Allowable load 2,0 kN/m <sup>2</sup>								
		Average platform bracket distance 1,20 m								
Tie rod		DW 15, max. load 90 kN, not weldable								
		DW 20, max. load 160 kN, not weldable								
Tie spacing		Horizontal 1,20 m								
Formwork height = concrete height	m	1,50	2,25	3,00	3,75	4,50	5,25	6,00	6,75	7,50
Quantity of ties holes in concrete	per m <sup>2</sup>	0,55	0,37	0,28	0,44	0,37	0,47	0,41	0,49	0,44
Tie rod guide		Reduction of ties in the concrete								

## Perfect all around with steel face

As an alternative to the Trapezoidal Girder Circular Formwork, PASCHAL is also offering the system with a steel face. The essential difference is that the trapezoidal girder in the steel version is connected with bolts through the girder to the back of the steel face: eliminating indentations and improving the concrete finish.

The max. concrete pressure for the Trapezoidal Girder Circular Formwork with steel face is 80kN/m<sup>2</sup> according to DIN 18218. With only four tie holes per 7,2m<sup>2</sup> (based on a 2,40x 3,00m segment).

The following are some advantages of the steel system:

- Top class concrete finish
- Adjusting range from  $r = \infty$  to  $r = 2,50$  m
- All dimensions are within tolerances
- Fewer tie holes in the concrete
- Full range of segment dimensions
- All filler pieces also fit
- Robust extensions
- Integrated crane lifting eye with high load capacity
- Top forming times

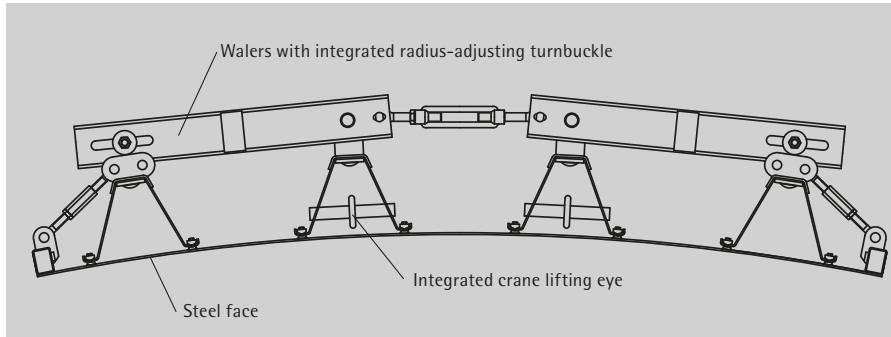

Waste water treatment plant, F-Brive la Gaillarde; Vigier/Sogea Sud Ouest, F-Toulouse



## Top class concrete surfaces



Waste water treatment plant, F-Brive la Gaillarde; Vigier/Sogea Sud Ouest, F-Toulouse

Round and nearly indent-free concrete surfaces are no problem with the Trapezoidal Girder Circular Formwork with steel face. All radii and also other curved forms are exactly set over the entire segment width and there are no irregularities even at a segment joint so that, for a start, the layout fits exactly.

In addition, the steel face provides a concrete surface that meets top class specifications, since the girders are bolted to the back of the steel face.

11

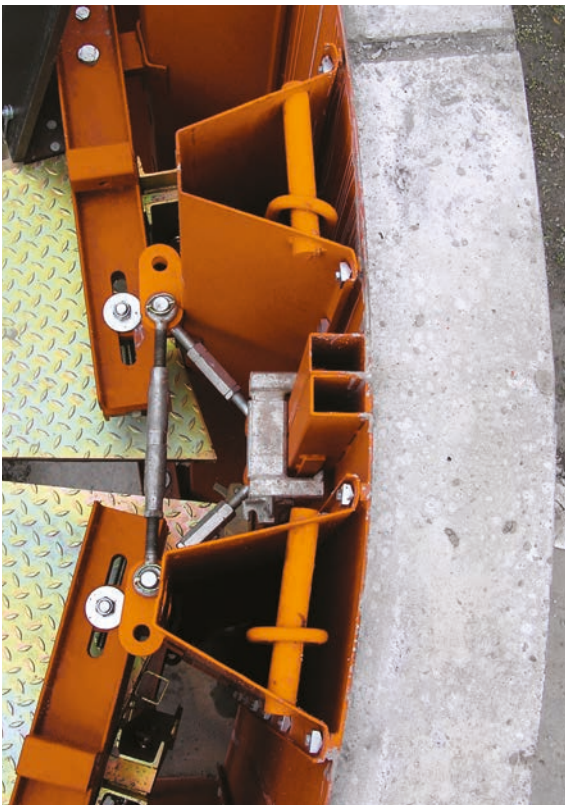

Exact curvature



Top class concrete surface



## Pre-assembly service from the manufacturer

The formwork is delivered to the construction site ready to use as designed, pre-rounded and extended. Additional mounting of walers is not necessary. There is very little work to be done on the forms. You only need to attach the accessories and start to pour concrete. Fillers are included in the PASCHAL system and thus do not have to be prepared on site.



Waste water treatment plant, F-Brive la Gaillarde; Vigier/Sogea Sud Ouest, F-Toulouse



STEP de St. Marcellin (38) ; Fa. NAVRO



## Technical details



- ① The segment connection tube as side part also holds the formwork tightly at the joints and is guaranteed to be leak-proof. There are only three GE clamps at 3.00m height fixing two large segments securely together.
- ② Integrated crane lifting eyes in each segment save one from having to constantly assemble and disassemble a non-fixed crane lifting eye. The wire or chain is hooked into eyes that are constantly present and a formwork segment is ready to be moved.
- ③ The integrated lever edge supports easy dismantling and erection of the formwork.
- ④ With the optional height-adjustable jackscrew, the formwork can be precisely adjusted.

11



Tunnel LGV Est européenne, F-Les Magny; Fa. GTM, F-Les Magny

## Parts list

	Art.-N°	Item	kg		Art.-N°	Item	kg	
		<b>TTS Segments for inside diameter from 5,00 m</b>				<b>TTS Segments for inside diameter from 5,00 m</b>		
		<b>Basic segment outside</b>					<b>Basic segment outside</b>	
	N122.201.0222	240x300 cm	765,00		N122.201.0239	240x75 cm	230,00	
	N122.201.0233	120x300 cm	405,00		N122.201.0237	120x75 cm	123,00	
	N122.200.0241	60x300 cm	225,00		N122.200.0247	60x75 cm	70,00	
		<b>Basic segment inside</b>				<b>Basic segment inside</b>		
	N122.201.0122	230x300 cm	735,00		N122.201.0139	230x75 cm	222,00	
	N122.201.0133	115x300 cm	396,00		N122.201.0137	115x75 cm	120,00	
	N122.200.0141	57,5x300 cm	214,00		N122.200.0147	57,5x75 cm	67,00	
					N181.000.0027	<b>GE/TTS panel clamp</b>	3,90	
					N181.000.0024	<b>GE/TTS panel clamp adjustable 0-5 cm</b>	2,85	
					N182.007.0005	<b>Locking screw TTS cpl.</b>	0,76	
					N182.007.0002	<b>Locking screw TTS for filler DW15</b>	0,60	
					N182.000.0210	<b>Turnbuckle M20 with lock nut M20</b> 320 - 470 mm	1,60	
					N182.000.0211	450 - 600 mm	2,10	
			N182.000.0212	600 - 750 mm	2,70			
			N182.000.0213	750 - 900 mm	3,30			
			N189.006.1000	<b>Tie rod, bevelled</b> DW 15 x 100 cm	1,40			
			N189.006.1350	DW 15 x 135 cm	1,85			
			N189.006.1500	DW 15 x 150 cm	2,10			
			N189.040.1250	DW 20 x 125 cm	3,20			
			N189.040.1500	DW 20 x 150 cm	3,90			
			N189.001.0059	<b>Plate with ball-and-socket joint</b> DW 15, 10 x 14 cm (inclin. max. 12°)	1,12			
			N189.001.0009	DW 20, 14 x 20 cm	1,65			
			Welding is not possible					

Subject to technical changes



## Parts list

	Art.-N°	Item	kg		Art.-N°	Item	kg
		<b>Plastic filler for TTS</b>			N282.000.0085	Extension post for Trapez. girders cpl.	20,00
	N182.007.0070	2 x 300 cm	4,00		N182.000.0032	Stop end guide cpl.	2,90
	N182.007.0071	4 x 300 cm	8,00		N189.001.0118	Double channel waler U 60 length 80 cm	8,20
	N182.007.0072	6 x 300 cm	12,00		N182.000.0284	Segment guide with wedge	2,50
	N182.007.0073	2 x 150 cm	2,00		N182.000.0219	Jackscrew for Trapezoidal capacity 1500kg	2,90
	N182.007.0074	4 x 150 cm	4,00		N182.000.0096	Suspending piece for props Trapezoidal girder	3,00
	N182.007.0075	6 x 150 cm	6,00		N182.000.0093	Ratchet key SW30	1,51
	N182.007.0076	2 x 75 cm	1,00		N182.000.0215	Multiple key SW36/27-SW30/24	1,40
	N182.007.0077	4 x 75 cm	2,00		N182.000.0179	Centering tool N/TR/R	0,67
	N182.007.0078	6 x 75 cm	3,00		N182.000.0283	Cover for trapezoidal girder T	0,18
		<b>Filler piece for TTS</b>		N189.002.0003	Transportation box hot-dip galvanized 1200 x 800 x 610 mm	86,50	
	N182.007.0010	8 x 75 cm	6,30	N940.009.0019	Cover lattice box/ transp. 1100 x 680 x 35 mm	6,70	
	N182.007.0011	10 x 75 cm	6,60				
	N182.007.0020	8 x 150 cm	12,90				
	N182.007.0021	10 x 150 cm	13,40				
	N182.007.0030	8 x 300 cm	25,40				
N182.007.0031	10 x 300 cm	26,40					
	N182.000.0089	<b>Tie rod guide with wedge T</b>	2,56				
	N182.000.0223	<b>Tie rod guide with crane lifting eye</b>	7,80				
	N182.000.0224	<b>Tie rod guide without crane lifting eye</b>	6,80				
	N182.000.0263	<b>Tie rod guide for segment height 37,5 cm</b>	2,40				
	N182.000.0053	<b>Platform bracket 90cm cpl. for Trapezoidal girder formw.</b>	11,10				
	N182.000.0133	<b>Platform bracket fastening Trapezoidal girder top mounted</b>	5,50				

Subject to technical changes



# Column

Column formwork





## Remain flexible – Save Time

The adjustable column formwork module Grip for example achieves short shuttering times together with high quality surface finish for open-faced concrete.

For circular columns PASCHAL offers formwork with steel surfaces for round and oval columns. Even with small-diameter objects the casting speed does not have to be reduced, a time-saving advantage. Also, using wall-shuttering modules of the Modular, LOGO.3 and Athlete series allows you to make so called multi-elements which can be deployed in the shuttering of columns.

## Grip column formwork

The variable Grip column formwork is also based on the windmill sail principle. Its main characteristics and advantages are:

- Variable from 20 to 60 cm in 5 cm steps without changing the plywood
- Suitable for rectangular or square sections
- Outstanding fair-faced concrete quality, without any impressions left by frames and plugs
- Moving with only one crane cycle. Only the tensioners need to be opened, and reclosed after moving
- Plastic coated 21 mm thick birch plywood with arris protection
- Heights: 340 cm  
300 cm  
150 cm  
90 cm
- Maximum concrete pressure, as per DIN 18218: 80 kN/m<sup>2</sup>
- By folding mechanism of the wings the space for storage and transport can be reduced

12



Supermarket, D-Kenzigen; Singler Bau, D-Hofstetten

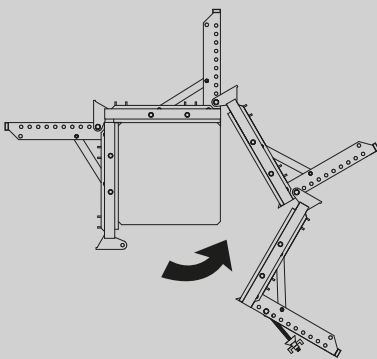

To remove the formwork, only the tensioners need to be undone, and the Grip wings can then be removed from the concrete and folded up.

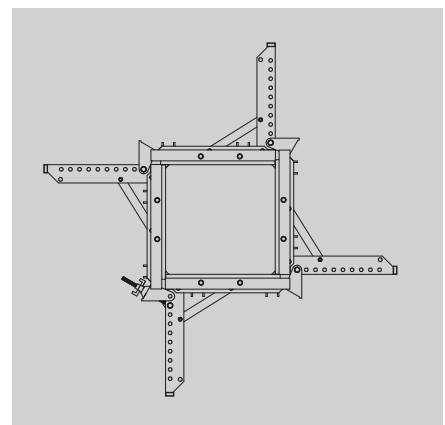
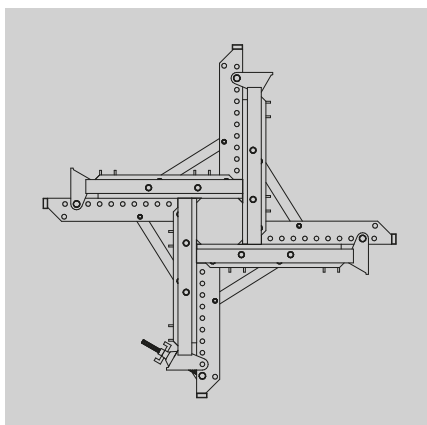

Both rectangular and square sections can be formed from 20x20 cm to 60x60 cm in 5 cm steps







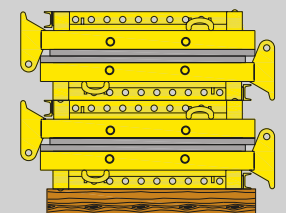
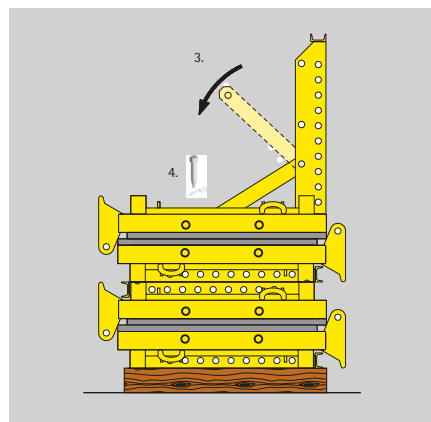
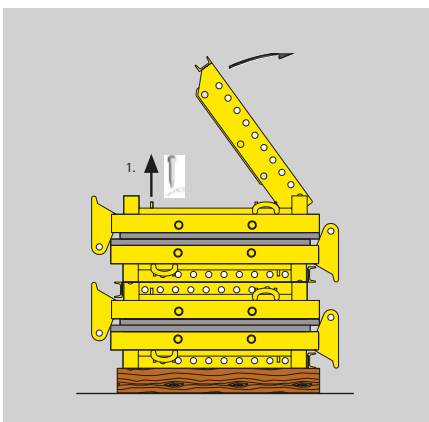



The Grip support formwork can be moved as a complete unit, with working platform and props, with only one crane cycle.

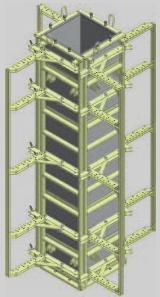
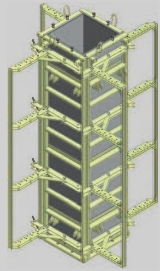
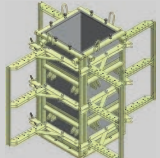
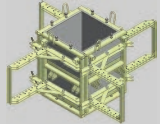

Thanks to the folding mechanism, the Grip needs little space for storage and is easy to transport.

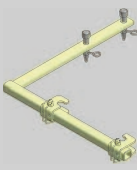
## Parts list

	Art.-N°	Item	kg		Art.-N°	Item	kg
   	N170.006.1000	Grip column formwork adjustable cpl. 340 cm	760,00	     	N170.006.0222	Guard rail Grip 75 x 79 cm	30,00
	N170.006.1001	Grip column formwork adjustable cpl. 300 cm	662,10		N170.006.0227	Guard rail Grip 120 x 79 cm for working platform	36,00
	N170.006.1002	Grip column formwork adjustable cpl. 150 cm	413,00		N170.006.0225	Guard rail Grip 120 x 30,5 cm for intermediate platform	27,00
	N170.006.1003	Grip column formwork adjustable cpl. 90 cm	262,00		N187.500.0063 N187.500.0071	Ladder for Multip 260 cm cpl. 130 cm cpl.	12,00 7,00
	N170.006.0226	Working platform Grip 125 x 80 cm cpl.	46,30		N170.006.0203	Ladder fastening Grip below cpl.	6,40
				N187.500.0074	Ladder fastening guard rail cpl. for Multip	2,00	

Subject to technical changes



## Parts list

	Art.-N°	Item	kg
	N170.006.0205	Grip trolley cpl.	39,60
	N170.006.0230	Grip extension angle 50 cm with 21mm plywood 4 pcs. cpl.	37,20
	N170.006.0232	without plywood 4 pcs. cpl.	16,40
	N170.006.0233	Plywood hkv 21x650x-500mm for Grip extension angle 50cm	5,20
	N949.000.0013	Sealing tape 12 x 3 mm 10m roll	0,03
	N170.006.0206	340 cm	0,40
	N170.006.0207	300 cm	0,40
	N170.006.0208	150 cm	0,20
	N170.006.0209	90 cm	0,10
			Chamfer angle fillets for column form Grip
	N170.003.0012	Plate with ball-and-socket joint DW15 d.75	0,64
	N170.006.0200	Grip eyescrew DW15x300	1,35
	N170.006.0204	Stacking screw M18x110 Grip	0,35
	N170.006.0210	Grip bolt D.20x135 galvanized	0,36

Subject to technical changes



Expansion production hall Pfeiffer, D-Friedenweiler; Co. Rombach GmbH; D-Titisee-Neustadt

## Circular column formwork

The PASCHAL circular column formwork consists of two identical half circles which are connected together with big keybolts rated for high tensile loads. The outstanding features and advantages include:

- Extremely economical with high use rates (inter alia no disposal costs).
- Extremely high load-carrying capacity up to 335 kN/m<sup>2</sup> depending on diameter; i.e. no-risk, fast concreting even of very high columns.
- The special design of the vertical joint with 5 mm overlap of the steel face prevents the concrete from bleeding.
- Panel heights of 75/125/150/275/300 cm for ideal adjustment in height.
- Available in standard diameters of 25 to 100 cm (in steps of 5 cm up to 50 cm diameter) and in special dimensions.
- Also ideal for building oval columns and semi-circular wall ends with connecting panels to PASCHAL Modular/GE Formwork.
- Problem-free fastening of working platforms and props.

13



Industrial project, Kirchberg; Hassel und Winter, Lendsiegel

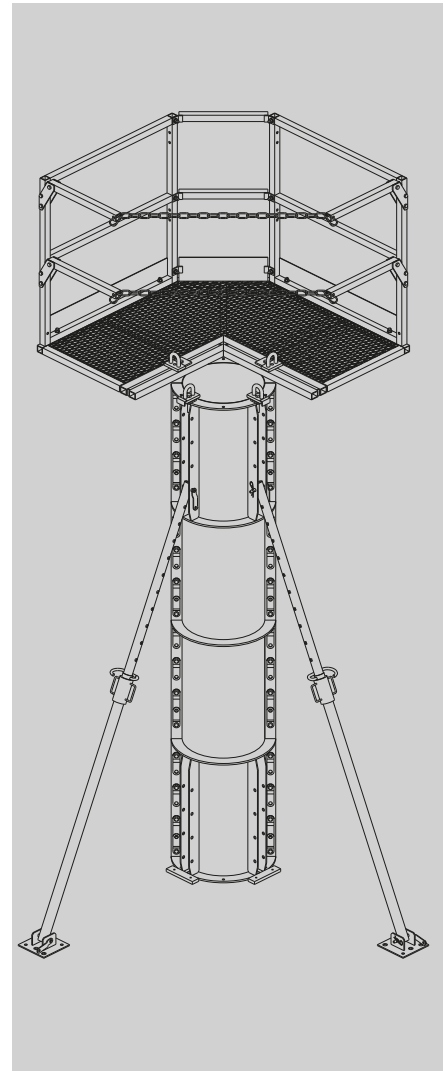

The particular advantages of PASCHAL circular column formwork include the great pour heights and the large quantities of columns which can be built.

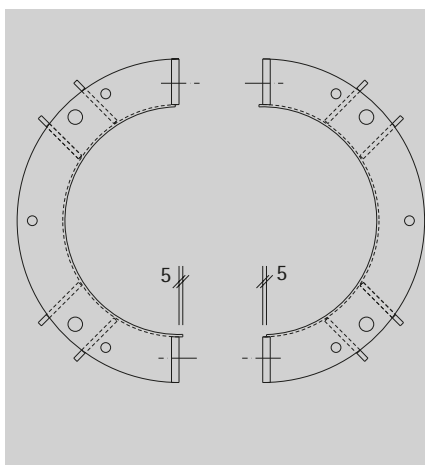

A 5 mm wide overlap of the steel faced plywood compared to the frame prevents any concrete from bleeding out of the joint of the half circles.

Load-carrying capacity of concrete pressure of the PASCHAL circular column formwork

d [cm]	p <sub>b</sub> [kN/m <sup>2</sup> ]
25	335
30	280
35	240
40	210
45	185
50	170
55	155
60	140
65	130
70	120
80	105
90	95
100	85



## Semi-circular wall end

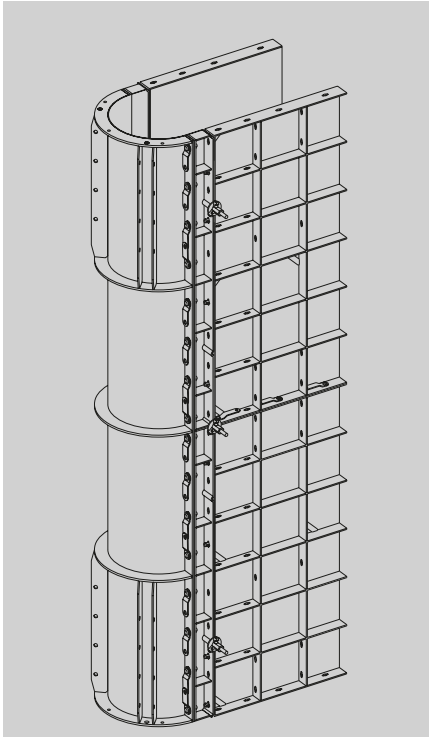

Circular column half circles with Modular formwork.



Semi-circular end of a wall in a sewage plant, built by combining circular column half circles with the Athlete formwork.

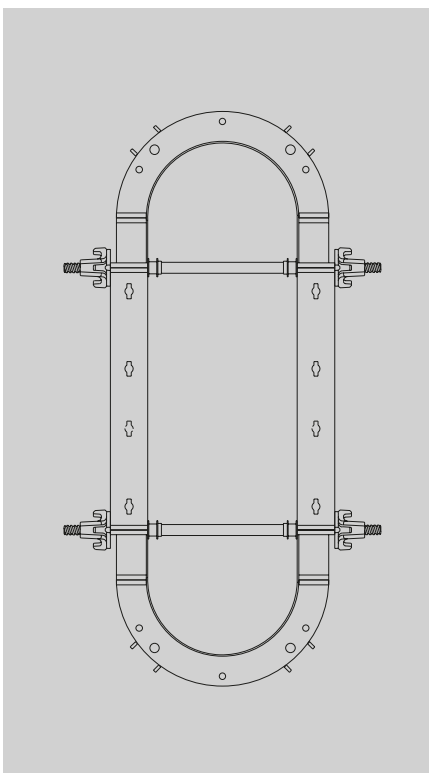

13

## Oval column





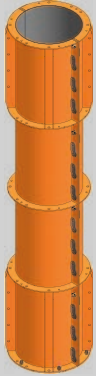

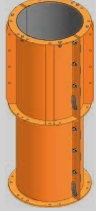
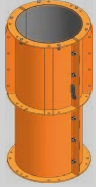



In these oval columns, special panels with steel face were connected directly to the half circles of the circular column formwork.

## Parts list

	Art.-N°	Item	kg		Art.-N°	Item	kg
		<b>Circular column form height 300 cm</b>			N145.070.1250	ø 70 cm	139,00
	N145.025.3000	ø 25 cm	182,00		N145.080.1250	ø 80 cm	153,00
	N145.030.3000	ø 30 cm	197,00		N145.090.1250	ø 90 cm	167,00
	N145.035.3000	ø 35 cm	212,00		N145.100.1250	ø 100 cm	180,00
	N145.040.3000	ø 40 cm	226,00			<b>Circular column form height 75 cm</b>	
	N145.045.3000	ø 45 cm	241,00		N145.025.0750	ø 25 cm	58,00
	N145.050.3000	ø 50 cm	256,00		N145.030.0750	ø 30 cm	63,00
	N145.060.3000	ø 60 cm	285,00		N145.035.0750	ø 35 cm	67,00
	N145.070.3000	ø 70 cm	315,00		N145.040.0750	ø 40 cm	71,00
	N145.080.3000	ø 80 cm	345,00		N145.045.0750	ø 45 cm	75,00
N145.090.3000	ø 90 cm	374,00	N145.050.0750	ø 50 cm	79,00		
N145.100.3000	ø 100 cm	404,00	N145.060.0750	ø 60 cm	88,00		
		<b>Circular column form height 275 cm</b>		N145.070.0750	ø 70 cm	96,00	
	N145.025.2750	ø 25 cm	170,00	N145.080.0750	ø 80 cm	105,00	
	N145.030.2750	ø 30 cm	184,00	N145.090.0750	ø 90 cm	113,00	
	N145.035.2750	ø 35 cm	198,00	N145.100.0750	ø 100 cm	122,00	
	N145.040.2750	ø 40 cm	212,00		<b>Keybolt-big for circular column</b>	0,30	
	N145.045.2750	ø 45 cm	226,00		<b>Key for big keybolt</b>	2,01	
	N145.050.2750	ø 50 cm	239,00		<b>Working platform cpl. N/R/RDS</b>	121,43	
	N145.060.2750	ø 60 cm	268,00		<b>Connecting piece for working platform circular column</b>	13,33	
	N145.070.2750	ø 70 cm	295,00		<b>Ladder fastening RDS cpl. for working platform</b>	9,40	
	N145.080.2750	ø 80 cm	323,00		<b>Foot grid circul. column cpl.</b>		
N145.090.2750	ø 90 cm	351,00		N185.000.0023	D.30-60 cm with trap	48,50	
N145.100.2750	ø 100 cm	378,00		N185.000.0024	D.65-100 cm with	70,00	
		<b>Circular column form height 150 cm</b>		N185.000.0025	D.30-60 cm w/o trap	44,00	
	N145.025.1500	ø 25 cm	93,00		<b>Bracket for circular column cpl.</b>	7,52	
	N145.030.1500	ø 30 cm	101,00		<b>Scaffold rail for bracket circular column cpl.</b>	5,90	
	N145.035.1500	ø 35 cm	109,00				
	N145.040.1500	ø 40 cm	117,00				
	N145.045.1500	ø 45 cm	124,00				
	N145.050.1500	ø 50 cm	132,00				
	N145.060.1500	ø 60 cm	148,00				
	N145.070.1500	ø 70 cm	163,00				
	N145.080.1500	ø 80 cm	179,00				
N145.090.1500	ø 90 cm	194,00					
N145.100.1500	ø 100 cm	210,00					
		<b>Circular column form height 125 cm</b>					
	N145.025.1250	ø 25 cm	78,00				
	N145.030.1250	ø 30 cm	85,00				
	N145.035.1250	ø 35 cm	92,00				
	N145.040.1250	ø 40 cm	99,00				
	N145.045.1250	ø 45 cm	105,00				
N145.050.1250	ø 50 cm	112,00					
N145.060.1250	ø 60 cm	126,00					



## Parts list

	Art.-N°	Item	kg
	N185.000.0032	Ladder bracket circul. column cpl.	7,10
	N185.000.0027	Scaffold tube for circul. column D.30-60cm	10,50
	N185.000.0028	Scaffold tube for circul. column D.65-100cm	12,60
	N185.000.0040	Crane lifting eye DW15 for circular columns, cap. 500kg	1,06
	N185.000.0029	Hexagon bolt DW15x50 galva	0,30
	N189.004.0043	Steel ladder 40/220cm cpl.	12,00
	N189.004.0044	Bottom ladder extension 40/95cm cpl.	7,00
	N189.004.0045	Bottom ladder extension 40/63cm cpl.	5,00
	N189.004.0046	Connection ladder 40/220cm cpl.	2,50
	N180.002.0067	Connection panel Circular-Modular 10 x 75 cm w.o. excess	8,70
	N180.002.0068	10 x 75 cm w. excess	8,80
	N180.002.0069	10 x 125 cm w.o. excess	14,40
	N180.002.0070	10 x 125 cm w. excess	14,50
	N180.002.0071	10 x 150 cm w.o. excess	17,10
	N180.002.0072	10 x 150 cm w. excess	17,20
	N180.002.0093	10 x 275 cm w.o. excess	31,00
	N180.002.0094	10 x 275 cm w. excess	31,00

## Modular column formwork adjustable

The adjustable Modular column formwork by PASCHAL is a steel frame formwork whose elements are assembled according to the so-called windmill principle.

- Available are element heights of 150 cm; 125 cm and 100 cm, which will be assembled depending on the height of columns to be concreted.
- As formwork facing a 15 mm thick, phenolic resin coated plywood is mounted in the elements.
- There is a maximum concrete pressure of 60 kN/m<sup>2</sup> according to DIN 18218 admissible. In assembled formwork with different element heights the smaller heights have to be used on bottom.
- Mounting options for accessories such as props, platform brackets or crane lifting clamps are available in the elements.
- With increased demands on the concrete surface (edges) at the panel joints, a glazing tape or chamfer strip can be mounted.

14



12 storey building, Busaiteen, Bahrain; Taitoon Contracting, BRN-Bahrain

Have you already seen it?





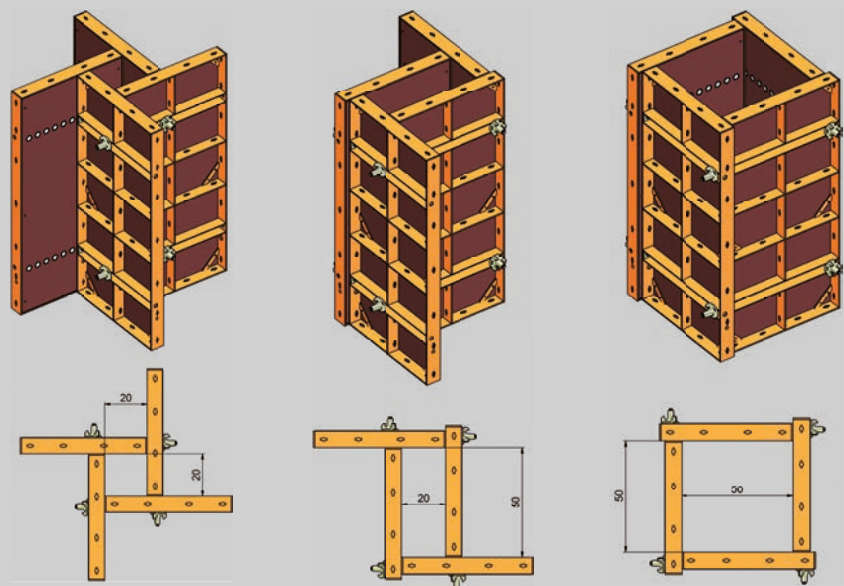







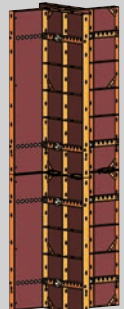

In our application video we present all product highlights of the Modular column formwork. It's worth taking a look!

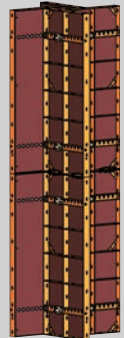
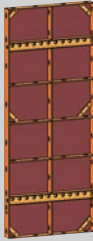

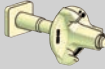
With four elements each square and rectangular column cross-sections can be formed in the adjustment range of 20 cm to 50 cm in increments of 5 cm.

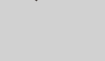

## Parts list

Parts list				Parts list			
	Art.-N°	Item	kg		Art.-N°	Item	kg
	N170.008.1000	Modular column formwork adjustable 20-50x250 cm cpl.	282,40		N170.008.0001	Modular column panel 60 x 100 cm	27,60
	N170.008.1001	Modular column formwork adjustable 20-50x275 cm cpl.	304,80		N170.008.0002	Modular column panel 60 x 125 cm	33,20
	N170.008.1002	Modular column formwork adjustable 20-50x300 cm cpl.	327,20		N170.008.0003	Modular column panel 60 x 150 cm	38,80
	N170.008.1003	Modular column formwork adjustable 20-50x325 cm cpl.	380,30		N170.008.0010	Locking screw DW15x160 for Modular column formwork	0,86
					N189.001.0100	Keybolt	0,19
					N189.002.0008	Crane lifting clamp KA capacity 600 kg	4,00
					N189.015.0000	PVC chamfer strip 2,3 x 2,3 x 250 cm	0,35
					N189.015.0002	1,2 x 1,2 x 250 cm	0,16
					N949.000.0013	Sealing tape 12 x 3 mm 10m roll	0,03

Subject to technical changes

## Modular column formwork

Even square and rectangular columns can be formed simply using panels, outside corner posts and keybolts of the PASCHAL Modular formwork system.

- The wide range of Modular panel widths allows the forming of all customary column cross sections without additional plywood.
- Combinations of different panel heights (150, 125, 75 and 62,5 cm) allow for ideal adjustment of formwork heights.
- The formwork can be completely dismantled, which is particularly useful when working on refurbishment projects.
- PVC chamfer angles simply clamped in position.
- The particularly favourable price of this column formwork means that many formwork sets can be kept on the building site for simultaneous concreting of many columns.
- Additional advantages when using available filling element.

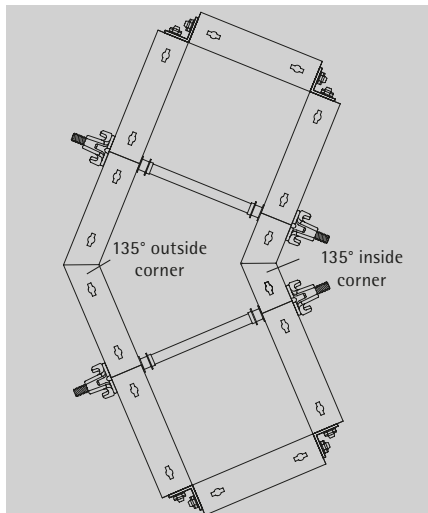
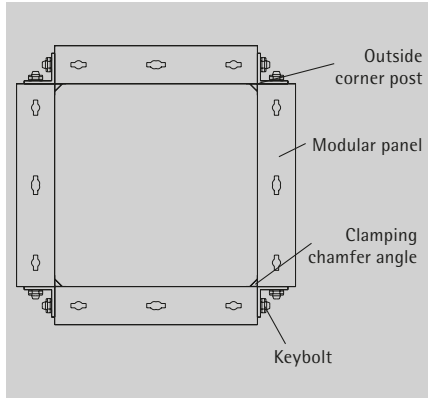

Angle column consisting of Modular panels and rigid 135° corners, suitable formed without expensive special formwork.



Golden Mile, VAE-Dubai, Fa. Al Shafar General Contracting Co., VAE-Dubai



## LOGO column formwork

### Solution 1:

4 LOGO multi-purpose panels are connected with locking screws (windmill sail principle) to produce a variable column formwork for cross sections from 20x20 cm to 75x75 cm, in steps of 5 cm. The cross sections can be square or rectangular.

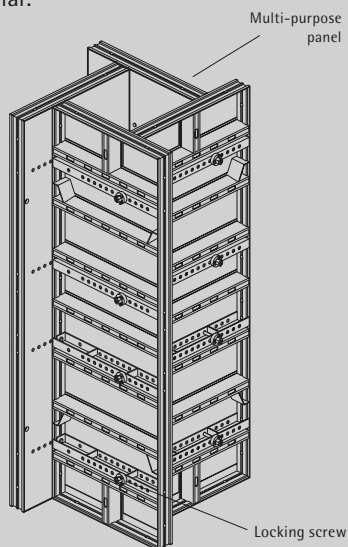

### Solution 2:

Combination of 2 multi-purpose panels and 2 compensation panels. LOGO compensation panels are available in widths from 20 cm in steps of 5 cm. The ideal solution for short walls up to 90 cm in length!

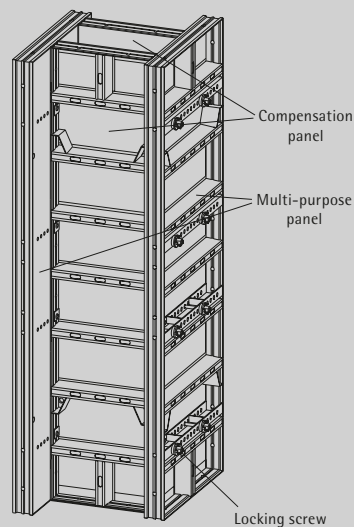

### Solution 3:

4 LOGO compensation panels and 4 LOGO outside corner posts are connected with the wedge clamp with curved wedge to a column form. Gradation between 20 cm and 60 cm in 5 cm increments.



### Solution 4:

Compensation panels in addition with squared timbers and plywood, joined by spacer channels. The spacer channels can be fitted to all customary dimensions and make any additional anchors superfluous.

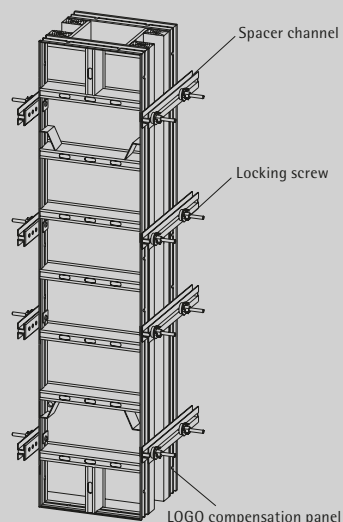

Components from the LOGO system can be used as column formwork with the special advantage that you can use already existing material. You do not need any special column panels, but simply take the same LOGO multi-purpose panels which you otherwise use to form right-angled corners.



Residential complex, D-Munich; Fa. Seb. Pöttinger GmbH & Co. KG Bauunternehmung, D-Ottobrunn

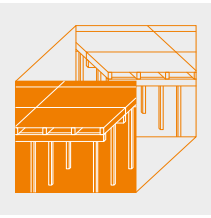

# Slabs

Slab formwork





## Technical data

PASCHAL Deck			
Admissible slab thickness	Variable according to distance between girders		
Tolerances of deflection	Max. Deflection $L/500$ according to DIN 18202		
H 20 Girder	Height 20 cm · adm. $M=5 \text{ kN/m}$ · adm. $Q=11 \text{ kN}$		
H 20 Girder lengths	180/245/290/330/360/390/490/600 cm		
Plywood 21 mm type 35	50x200 cm with/without arris protection		
Fork head	Tip protection for H 20 girder		
H 20 Prop head	Fixation for intermediate props		
Slab props	D 15; B/D 25 (N1); B/D 30 (N2); B/D 35 (N3); C/D 40 (G4); C 55 (G7)		
Tripod	Erecting auxiliary for slab props		
Guard rail bar	Fall protection for free slab edges		
Slab edge formwork			
Admissible distance between brackets	for 20 cm slab thickness	Cantilever [cm]	Distance [cm]
		0	200
		10	200
		20	200
		30	200
		40	150
Admissible distance between brackets	for 30 cm slab thickness	Cantilever [cm]	Distance [cm]
		0	155
		10	155
		20	145
		30	115
		40	90
	50	70	

## PASCHAL Deck

PASCHAL Deck is a flexible slab formwork consisting of three main components:

- Plywood
- H20 girder
- Slab prop

This system is ideal for use with different slab thicknesses, as only the statically necessary parts are used. Loose plywood plates, supported by H20 girders, (cross girders) serve as decking. The same H20 girders are used as main girders to support the cross girders. The same parts can be used in both directions.



„Schierker Feuerstein-Arena“ winter sports facilities; Umwelttechnik und Wasserbau GmbH & STRATIE Bau GmbH

Main girders  
Cross girders

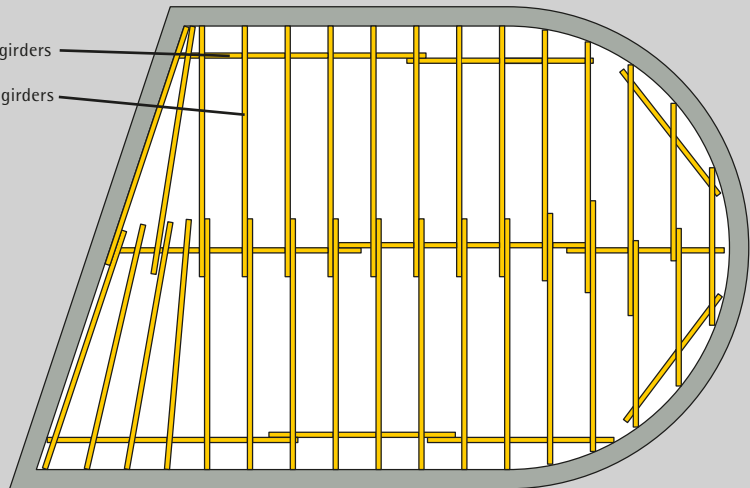

Main girders  
Cross girders

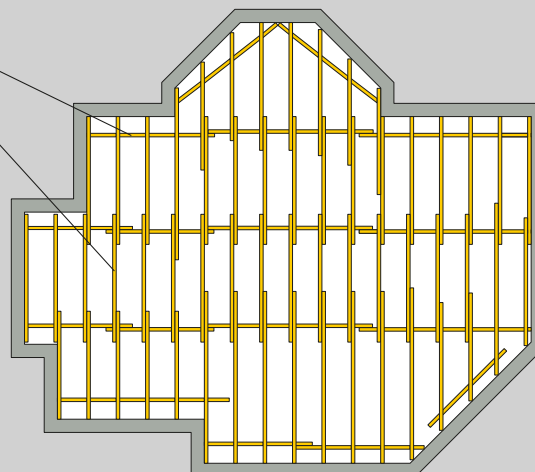



## Assembly sequence

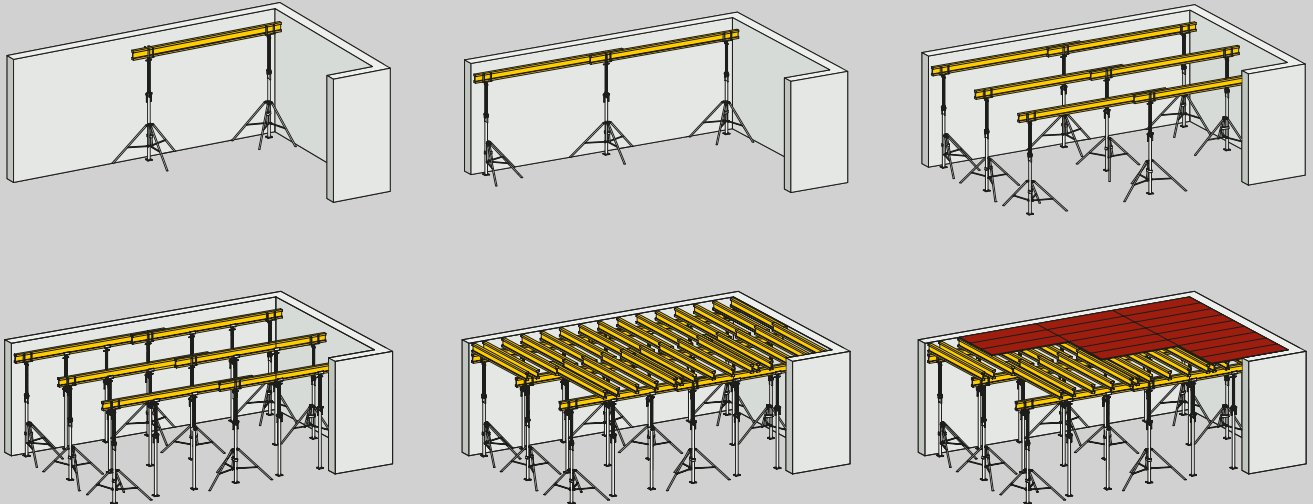

## H 20 girder

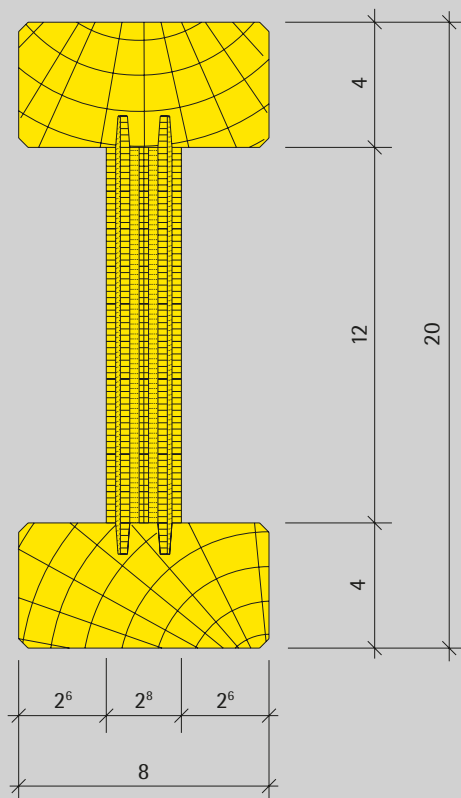

H 20 girder

Max. bending moment:  
max.  $M = 5,0 \text{ kNm}$

Max. shear force:  
max.  $Q = 11,0 \text{ kN}$

H20 girders convince by their universal applicability in different systems and are therefore used on construction sites worldwide.

The flexibility of the system, i.e. its ability to adapt to various different room sizes, comes from the overlapping of the H20 girders. It is of no significance whether the girders are used as main girders or cross girders. Overlapping in any dimension is possible in either direction. Similarly the main girders and cross girders can be turned in the statically required direction for slanting T-walls, wall abutments, bays, circular structures, etc.

- use with shoring systems (also slab and beam formwork) and for girder wall formwork
- deployable as main and cross beam
- absorption of a high bending moment
- low weight, easy handling

## Practical examples

The special advantages of PASCHAL Deck at a glance:

- Less number of different parts
- Flexible adjustment to every layout
- Optimum use of material
- Low weight of the parts
- Always the same assembly sequence
- Can also be used as support for partially pre-fabricated slabs
- Low material price



Technical college D- Holzkirchen; Bauunternehmung Ehrenfels GmbH

The fork head at the joint of the main girders prevents the H20 girders from tilting. Intermediate props are suspended at the main girders with the H20 prop head.



„Schierker Feuerstein-Arena“ winter sports facilities; Umwelttechnik und Wasserbau GmbH & STRATIE Bau GmbH



## Beams

You will find solutions for forming beams in chapter Modular/GE Universal Formwork.



Medical faculty Algiers, DZ-Algiers ; Fa. Entreprise COSIDER-Construction, DZ-Dar El Beida, Algiers

16

















High-rise project, D-Freiburg; Ed. Züblin AG, Karlsruhe department, in the Freiburg region

## Slab props Max. safe working load as per DIN EN 1065

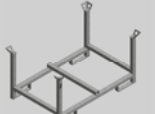
[m]	B/D 15 0,96 - 1,50 m			B/D 25 1,55 - 2,50 m			B/D 30 1,70 - 3,00 m			B/D 35 1,95 - 3,50 m			C/D 40 2,30 - 4,00 m			C/D 55 3,10 - 5,50 m		
	B [kN]	D [kN]	B/D [kN]	B [kN]	D [kN]	B/D [kN]	B [kN]	D [kN]	B/D [kN]	B [kN]	D [kN]	B/D [kN]	C [kN]	D [kN]	C/D [kN]	C [kN]	D [kN]	C/D [kN]
1,00	30,9	20,0	30,9															
1,10	30,9	20,0	30,9															
1,20	30,9	20,0	30,9															
1,30	30,9	20,0	30,9															
1,40	30,9	20,0	30,9															
1,50	27,5	20,0	27,5	30,9	20,0	30,9												
1,60				30,9	20,0	30,9												
1,70				30,9	20,0	30,9	30,9	20,0	30,9									
1,80				30,9	20,0	30,9	30,9	20,0	30,9									
1,90				28,5	20,0	28,5	30,9	20,0	30,9									
2,00				25,8	20,0	25,8	30,9	20,0	30,9	30,9	20,0	30,9						
2,10				23,4	20,0	23,4	28,0	20,0	28,0	30,9	20,0	30,9						
2,20				21,3	20,0	21,3	25,5	20,0	25,5	29,8	20,0	29,8						
2,30				19,5	20,0	20,0	23,4	20,0	23,4	27,3	20,0	27,3	36,1	20,0	36,1			
2,40				17,9	20,0	20,0	21,5	20,0	21,5	25,0	20,0	25,0	36,1	20,0	36,1			
2,50				16,5	20,0	20,0	19,8	20,0	20,0	23,1	20,0	23,1	36,1	20,0	36,1			
2,60							18,3	20,0	20,0	21,3	20,0	21,3	36,1	20,0	36,1			
2,70							17,0	20,0	20,0	19,8	20,0	20,0	33,9	20,0	33,9			
2,80							15,8	20,0	20,0	18,4	20,0	20,0	31,5	20,0	31,5			
2,90							14,7	20,0	20,0	17,2	20,0	20,0	29,4	20,0	29,4			
3,00							13,7	20,0	20,0	16,0	20,0	20,0	27,5	20,0	27,5			
3,10										15,0	20,0	20,0	25,7	20,0	25,7	35,4	20,0	35,4
3,20										14,1	20,0	20,0	24,1	20,0	24,1	33,2	20,0	33,2
3,30										13,2	20,0	20,0	22,7	20,0	22,7	31,2	20,0	31,2
3,40										12,5	20,0	20,0	21,4	20,0	21,4	29,4	20,0	29,4
3,50										11,8	20,0	20,0	20,2	20,0	20,2	27,8	20,0	27,8
3,60													19,1	20,0	20,0	26,2	20,0	26,2
3,70													18,1	20,0	20,0	24,8	20,0	24,8
3,80													17,1	20,0	20,0	23,5	20,0	23,5
3,90													16,3	20,0	20,0	22,4	20,0	22,4
4,00													15,5	20,0	20,0	21,3	20,0	21,3
4,10																20,2	20,0	20,2
4,20																19,3	20,0	20,0
4,30																18,4	20,0	20,0
4,40																17,6	20,0	20,0
4,50																16,8	20,0	20,0
4,60																16,1	20,0	20,0
4,70																15,4	20,0	20,0
4,80																14,8	20,0	20,0
4,90																14,2	20,0	20,0
5,00																13,6	20,0	20,0
5,10																13,1	20,0	20,0
5,20																12,6	20,0	20,0
5,30																12,1	20,0	20,0
5,40																11,7	20,0	20,0
5,50																11,2	20,0	20,0

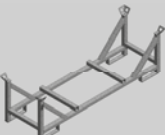

## Parts List

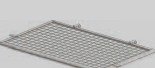
	Art.-N°	Item	kg		Art.-N°	Item	kg				
	N940.030.0180	Wooden girder H20 180 cm	8,40		N183.001.0001	Forked assembly tool for wooden girder H20 chromated	3,30				
	N940.030.0245	245 cm	11,30								
	N940.030.0290	290 cm	13,40								
	N940.030.0330	330 cm	15,20								
	N940.030.0360	360 cm	16,60								
	N940.030.0390	390 cm	18,00								
	N940.030.0490	490 cm	22,50								
	N940.030.0600	600 cm	27,60								
	N189.005.0102	Slab prop DIN EN 1065 D15 96-150 cm	10,50		N189.000.1021	Clamping piece (up to 60cm) lateral protection Secuset	5,10				
	N189.005.0087	B/D25 155 - 250 cm	14,00								
	N189.005.0088	B/D30 175 - 300 cm	15,90								
	N189.005.0089	B/D35 200 - 350 cm	19,10								
	N189.005.0097	C/D40 230 - 400 cm	22,40								
	N189.005.0107	D55 310 - 550 cm	35,50								
		N806.210.0065	Plywood 3plies 21 mm without arris protection 50 x 150 cm					7,50		N189.000.1001	Railing post 120 cm lateral protection Secuset
N806.210.0066		50 x 200 cm	10,00								
N806.210.0067		50 x 250 cm	12,50								
without arris protection		N806.210.0068	50 x 150 cm	7,50	N189.000.1011	Support for protection fence Secuset	0,21				
		N806.210.0069	50 x 200 cm	10,00							
		N806.210.0070	50 x 250 cm	12,50							
with arris protection		N806.210.0068	50 x 150 cm	7,50	N189.000.1010	Support for toe board lateral protection Secuset	0,46				
		N806.210.0069	50 x 200 cm	10,00							
		N806.210.0070	50 x 250 cm	12,50							
		N940.031.0001	Fork head f. wooden girder H20	3,25		N189.000.1030	Lateral protection fence 260 cm Secuset	19,80			
	N183.001.0002	H20 prop head	1,30								
	N940.031.0004	Spring bolt 14 x 145	0,20		N189.002.0004	Stacking pallet 165 x 110 cm hot-dip galvanized	59,00				
	N940.031.0002	Tripod for slab props	10,50								
	N940.031.0003	for slab props until size D55, clamp. range <D.90mm	7,60		N189.002.0005	Stacking pallet 240 x 80 cm hot-dip galvanized	72,50				
	N183.001.0003	Connecting piece wooden girder H20/H20	0,75								
	N940.100.0018	Bracing clamp	1,10		N940.009.0017	Lattice box pallet PASCHAL 120 x 81 x 93 cm	65,00				
	N940.009.0018	Lattice box pallet small PASCHAL 120 x 81 x 46 cm	50,00								
	N940.009.0019	Cover lattice box/ transp. 1100 x 680 x 35 mm	6,70		N940.009.0019	Cover lattice box/ transp. 1100 x 680 x 35 mm	6,70				

## Slab edge formwork

Slab edge formwork is made up of three components. Load-bearing component is the bracket which is bolted to the wall using a wall-plug or a tie rod. The stop is then assembled on the bracket by means of a hook-head connection. This stop can be infinitely adjusted between zero and 50 cm, according to whether slab edge and wall are flush, or whether a small projection has to be concreted. So that necessary work safety is always guaranteed, lateral protection in which side protection boards and shelf are located are fixed to the stop.

A further possible use for the brackets is as formwork for floor-slabs or free slab edging. The type of formwork is variable; planks may be used as well as formwork elements.

This means:

- 17 ■ Few parts
- Adjustable for a variety of formwork requirements
- Universal application
- Integrated safety at work



For concreting the brackets, the stop can be adjusted by up to 50 cm.



Fixing to the wall is achieved either by using wall-plugs with bolts or with DW 15 tie rods.

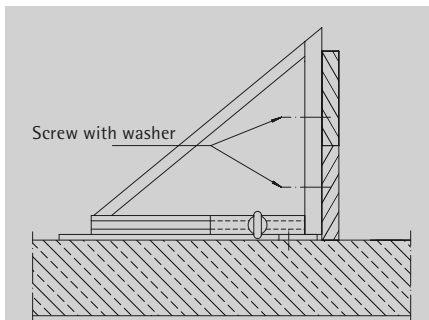



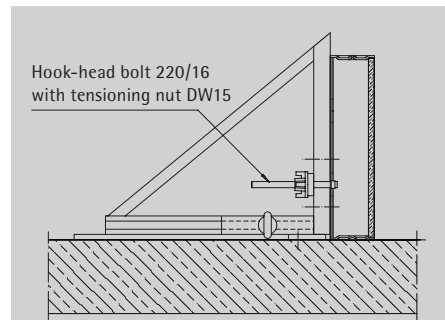







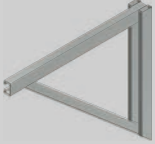
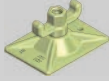

Conventional formwork with planks

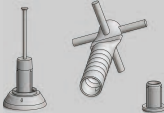
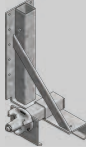
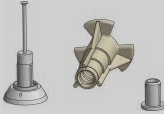
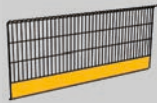

Formwork with steel frame elements lying down (e.g. LOGO, Modular)

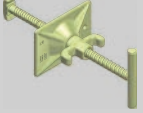

## Parts List

	Art.-N°	Item	kg		Art.-N°	Item	kg
	N183.003.0001	Slab edge bracket 60 cm galvanized	5,10		N189.001.0059	Plate with ball-and-socket joint DW 15, 10x 14 cm inclin. max. 12°	1,29
	N189.000.0030	Slab edge stop Secuset	4,50		N189.000.1001	Railing post 120 cm lateral protection Secuset	3,20
	N183.003.0020	Slab edge wing screw DW15 x 115	0,55		N189.000.1011	Support for protection fence Secuset	0,21
	N183.003.0030	Slab edge bracket connector	1,20		N189.000.1010	Support for toe board lateral protection Secuset	0,46
	N940.014.0163	V2A Uni concrete anchor DW 15 cpl. w. cone peg and cap	0,17		N189.000.1022	Edge stop H20 Secuset	4,15
	N940.014.0168	Uni concrete bush DW15 cpl. with cone peg and cap	0,07		N189.000.1030	Lateral protection fence 260 cm Secuset	19,80
	N183.003.0015	Fixing plate slab edge bracket	6,00		N189.000.1035	Lateral protection fence Secuset 230 x 80 cm	10,10
	N189.005.0041	Ground nail d.20 x 55 cm forged	1,70		N189.000.1036	Lateral protection fence Secuset 130 x 80 cm	6,50
	N187.500.0021	Support for walers DW 15 clamping length 6 - 20 cm L/N/A	1,95				
	N189.001.0031	Waler guide 100 clamping length 10 cm N/R	0,50				

Subject to technical changes



# Climbing

Climbing and platforms





## Remain flexible

With their novel and versatile climbing brackets PASCHAL offers solutions which can be perfectly adapted to special construction problems. This gives you more flexibility and saves time.

PASCHAL climbing brackets may be combined with any formwork system. The novel Climbing system 240 cm follows calls for more flexibility and allows the adaptation to the building's geometry of up to +/- 15 degrees. With this system big formwork modules a height of up to 4.50 m can be realized, which saves time and money.



### General Construction Supervisory Approval (called abZ)

By obtaining the General Technical Approval for the PASCHAL Climbing Cone M30/DW15 a standardized system to anchor climbing brackets is available for all PASCHAL climbing and platform systems.

Hereby the PASCHAL Climbing system 240, the Climbing system 200, the Climbing platform KBK, Dam bracket and the Lifting platform for shafts can be dimensioned by secured parameters.



## Climbing system 240

It supports the efficiency and cost effectiveness of climbing systems in adjusting flexibly to the structure geometry and in permitting larger formwork units.

With the climbing bracket 240 cm PASCHAL wall formwork systems can be also used as climbing formwork. This is especially an advantage for building a structure in several height phases.

A complete climbing unit consists of climbing platform (bracket + planking), formwork, concrete and suspended scaffold and can be moved with only one crane cycle. Hereby efficient and economic work sequences can be achieved.

- Can be adjusted up to +/- 15 degrees on the geometry of the structure
- High load-bearing capacity
- Saving of time and costs by transposing of larger formwork units
- Long service life and functionality by hot-dip galvanizing as surface protection
- High degree of safety at work by working space in front of and behind the formwork
- Little transport volume by modular construction

18



Hotel, D-Lörrach; Implenia Bau GmbH, D-Rümmingen



Hotel, D-Lörrach; Implenia Bau GmbH, D-Rümmingen



Tree canopy walkway „Heidehimmel“, D- Bad Iburg; Holtmeyer Bauunternehmen GmbH

Bracket depth:	2,40 m
Live loads:	Working platform: 4,5/3,0 kN/m <sup>2</sup>
	Concrete platform: 1,5 kN/m <sup>2</sup>
	Suspended scaffold: 1,0 kN/m <sup>2</sup>
Inclination:	+/- 15°





Ore Processing Plant, OM-Suhar; Galfar Engineering & Contracting, OM

## Climbing systems 200

PASCHAL climbing systems – the complete solution for safe and economical climbing. The climbing units consist of rigid or slidable climbing brackets, adjustable props for supporting the formwork, boards, railing and possibly suspended scaffolds. The compact climbing brackets can be used as:

- Climbing units with permanently attached hinged formwork which can be moved in one step by a crane.
- Climbing units with slidable formwork: the formwork is assembled on a carriage which can be moved back 60 cm on the running rail.
- Working scaffold with 2,00 m board width. Flexible scaffold units can be adjusted to many different layout types for optimum utilisation and reduction of the anchoring systems.



City Theatre, D-Gütersloh; Fechtelkord & Eggersmann GmbH, D-Marienfeld

Scaffold width:	2,00 m
Live loads:	Working platform: 3,0 kN/m <sup>2</sup>
	Suspended scaffold: 1,0 kN/m <sup>2</sup>
Working heights:	up to 100 m above ground level
Formwork heights:	up to 5,60 m
Anchoring:	Clevis shoe with anchor cone M30
Accessories:	Panel supports and height adjustment units for all PASCHAL formwork systems
	Tension anchoring for wind loads
	Traps



## Climbing platform KBK 180

The climbing platform KBK, folding is a working and climbing scaffold which is supplied to the building site ready assembled. After erecting the guard railing post and unfolding the platform, KBK is ready to use and can be dropped into the clevis shoe using the crane.

Possible uses:

- Climbing platform with erected formwork up to 5,60 m high
- Working platform for concrete and brickwork construction
- Protection and safety scaffold



Production hall, D-Endingen; Ernst Späth, D-Endingen



20

Platform width:	180 cm
Platform length:	295 cm Corner platforms: 390 cm
Bracket spacing:	200 cm
Maximum loads	3 kN/m <sup>2</sup> as climbing platform with erected formwork
	4,5 kN/m <sup>2</sup> as working platform without formwork
	2 kN/m <sup>2</sup> as working and safety platform with drop-in loop according to DIN 4420
Anchoring:	Clevis shoe M30 with screw anchor or anchor cone
	Drop-in loops as per DIN 4420
Accessories:	Corner platforms
	Individual brackets
	Connection part for drop-in loops
	Clevis shoe M30
	Bracket extensions
	Railing posts for lateral protection
	Suspended scaffold
	Traps
	Drop-in loops as per DIN 4420

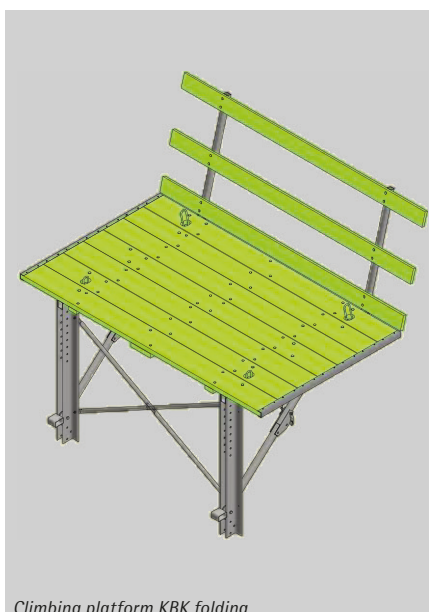

Climbing platform KBK folding

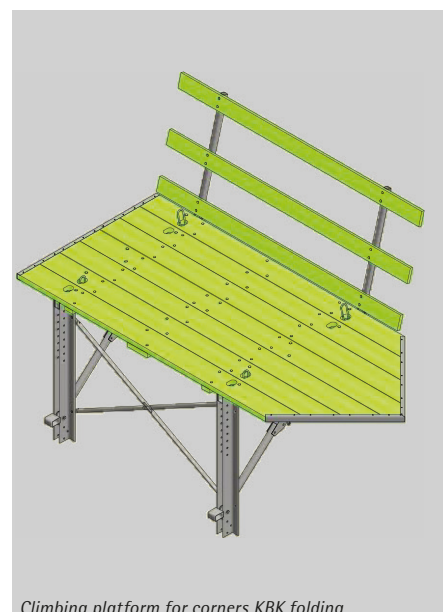

Climbing platform for corners KBK folding



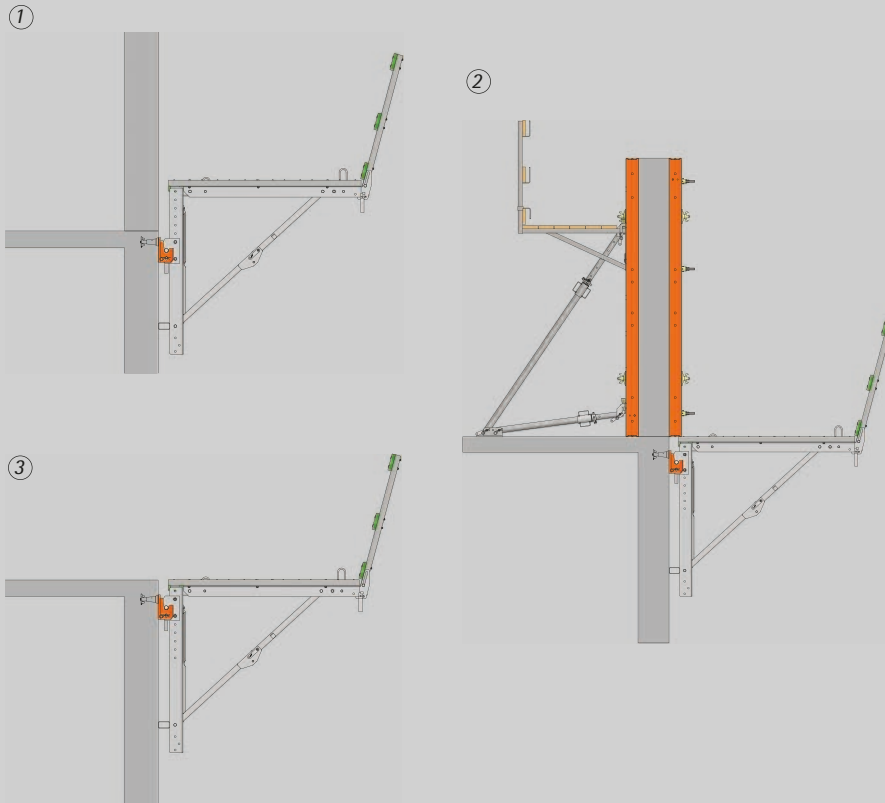

① The platform can be extended up to 45cm beyond the clevis shoe for height adjustments.

② Climbing platform for erecting formworks: In this case (drawing on the left), the platform has to be dropped into in the clevis shoe M30. The shoe is fastened in the reinforced concrete slab or in the wall below by means of an anchor cone or screw anchor. Before positioning the outside formwork (fitting of the reinforcement), the platform can take loads of up to 4,5kN/m<sup>2</sup>. After the formwork has been erected, its load-carrying capacity is reduced to 3,0kN/m<sup>2</sup>.

③ Climbing platform as working, protection and safety platform: In these cases, anchoring with drop-in loops as per DIN 4420 can be used as long as the existing surface load does not exceed 2,0kN/m<sup>2</sup>. 2 drop-in loops are required for each bracket. This means 4 loops per platform.



Technical college D-Holzkirchen; Bauunternehmung Ehrenfels GmbH, D-Karlstadt

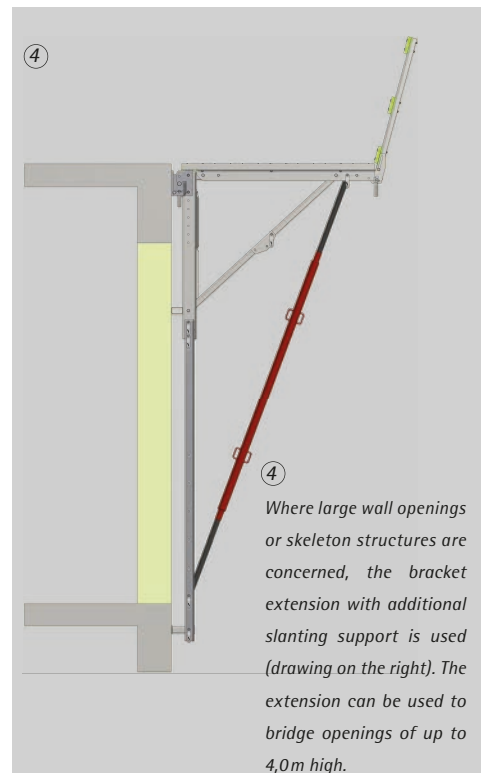

④ Where large wall openings or skeleton structures are concerned, the bracket extension with additional slanting support is used (drawing on the right). The extension can be used to bridge openings of up to 4,0m high.

## Dam bracket SPK 270

with suspended scaffold cpl. (max. inclination 38° as on illustration)

PASCHAL Dam bracket is used wherever single-sided climbing is required, for example for reservoir dams, port and harbour constructions, lock-up constructions in inner city projects and refurbishment measures.

- All PASCHAL formwork systems can be assembled as single-sided formwork on the dam brackets and adjusted to the sides and in height using the adjustment units.
- The formworks can be tilted forward for dismantling and returned on a carriage.
- The robust structure of the dam brackets facilitates economic bracket spacing and phase heights.

The formwork panels can be tilted in fully variable positions on the dam brackets in both directions, allowing for ideal adjustment to the full range of wall slopes and wall abutments. All working platforms remain horizontal while the formwork is tilted.

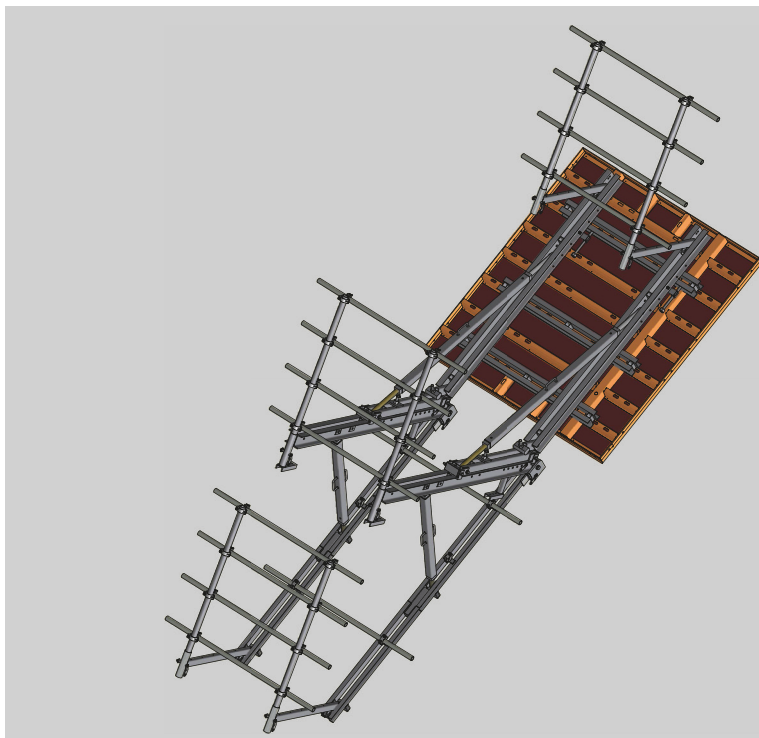
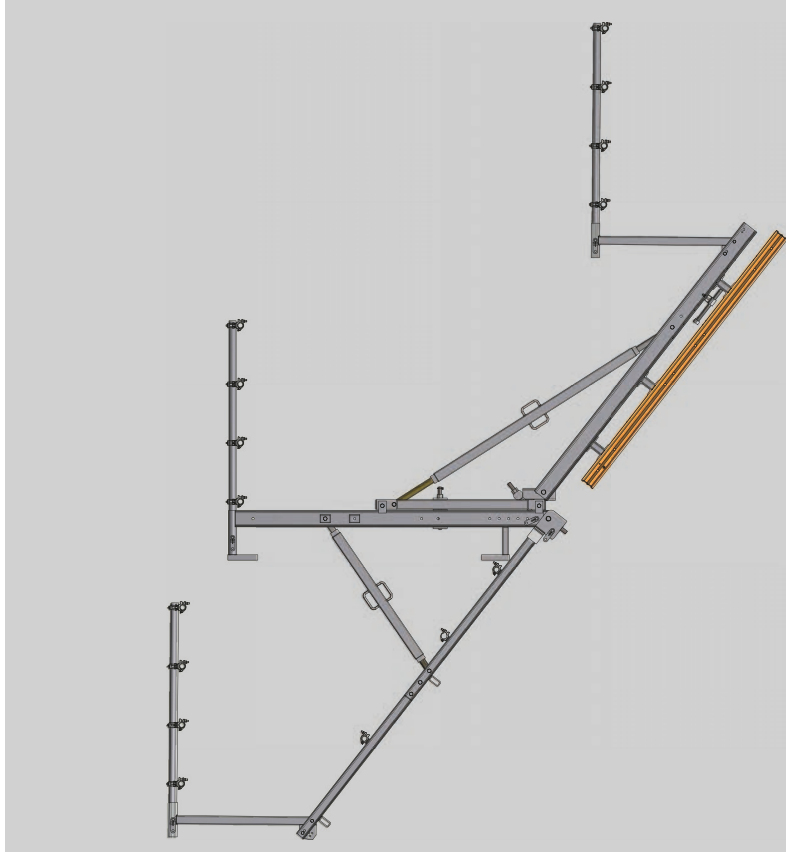





Barrage de St. Marc; Eiffage TP Agence Clermont-Ferrand, Resirep

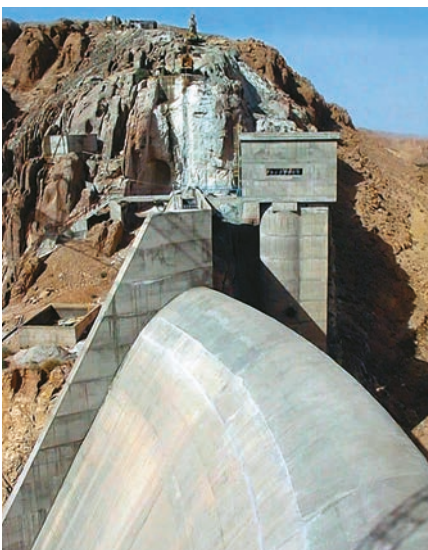

Dam „Barrage de Brezina“, Algeria; SEROR, Tlemcen/Algeria



## Lifting platforms

Lifting platforms are used as working platforms and for raising and moving inside formwork for elevator shafts and staircase cores as well as other structures where normal climbing units cannot be used because of the lack of space. The PASCHAL klik-klak beams are a modular component system which can be adjusted to all layouts.

Important features and advantages of the PASCHAL lifting platforms:

- The complete working platform unit with inside formwork and suspended scaffold can be moved in one step by a crane
- End pieces of the klik-klak beams with crane lifting eye and possibility for fastening suspended scaffold
- Hinged shoe for fitting onto support brackets



22

Max. span of the beams:	5,00 m
Max. spacing between beams:	1,70 m
Max. load on the beams	2 kN/m <sup>2</sup> + dead weight of the formwork 3 kN/m <sup>2</sup> without formwork
Formwork heights:	up to 4,50 m
Support:	Support brackets of steel, anchored in the concrete with screw anchors or anchor cones
Single parts and accessories:	End pieces with hinged shoe Center pieces: 100, 50, 20, 10, 2 cm Support brackets

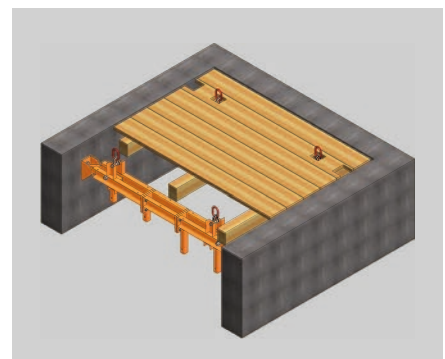
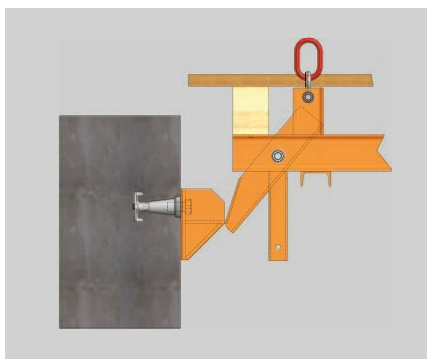
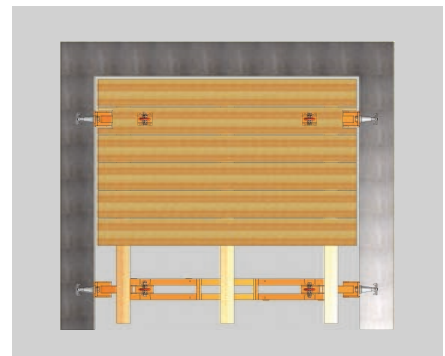
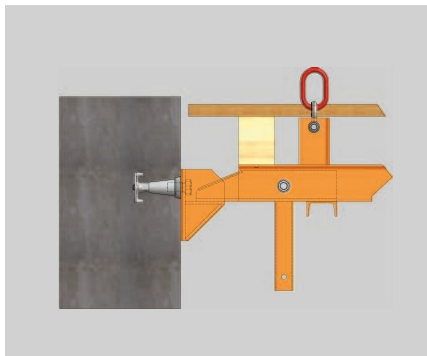











**Parts list** Climbing system 240

	Art.-N°	Item	kg		Art.-N°	Item	kg
	N186.002.0023	Horizontal beam, climbing bracket mount.	95,00			Double channel waler U openings 30mm	
	N186.002.0024	Vertical beam, climbing bracket mount.	68,33		N189.001.0135	100x2450	52,50
	N186.002.0035	Diagonal for climbing bracket rigid - galvanized	23,60		N189.001.0132	100x2950	63,00
	N186.002.0029	Guardrail post galvanized	16,40		N189.001.0133	100x3950	84,00
	N186.002.0025	Running cart, climbing bracket mount.	49,60		N189.001.0134	100x4950	105,00
	N186.002.0036	Fixation running cart for climbing bracket mount.	7,90				
	N186.002.0033	Vertical beam 299 cm mount.	81,60		N186.002.0032	Fixation for double U100 galvanized	1,30
	N186.002.0039	Vertical beam 480 cm mount.	130,00				
	N186.002.0034	Push pull prop 200-275 cm for climbing bracket	36,20		N189.001.0059	Plate with ball-and-socket joint DW15 10x14cm inclin. max.12°	1,29
	N186.002.0028	Concrete platform mount.	13,70				
	N186.002.0038	Guardrail, climbing bracket mount.	8,80		N187.500.0021	Support for walers DW15 clamping length 6-20cm L/N/A	1,95
N186.002.0027	Height adjustment mount.	6,40					
N186.002.0031	Vertical beam, suspended scaff. for climbing bracket	41,80					
N186.002.0041	Vertical beam suspended scaffold 250cm for climbing bracket mount.	50,80					
N186.002.0028	Concrete platform mount.	13,70					
N186.002.0038	Guardrail, climbing bracket mount.	8,80					
N186.002.0007	Suspended roller D.115x45 M30 galvanized	1,50					

18  
19  
20  
21  
22

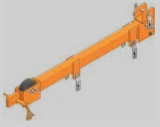
Subject to technical changes

**Parts list** Climbing systems 200

	Art.-N°	Item	kg
	N250.000.0009	Climbing bracket 200 cm cpl. rigid for scaff rail pluggable	66,02
	N250.000.0012	Climbing bracket 200 cm cpl. slidable for scaff rail pluggable	61,00
	N250.000.0010	Scaffold rail 250 cm for climbing bracket 200 cm cpl.	20,00
	N186.000.0009	Running rail 174 cm cpl. for climbing bracket 200 cm	13,00
	N186.000.0010	Carriage cpl. for climbing bracket 200 cm	22,51
	N186.000.0012	Suspended scaff. cpl. to 280 cm for climbing bracket 200 cm	34,75
	N186.000.0033	Panel support LOGO cpl.	40,50
	N186.000.0018	Panel support Modular cpl.	10,40
	N186.000.0019	Panel support GE cpl.	17,50

	Art.-N°	Item	kg
	N186.000.0021	Support for Trapez. girders for climbing bracket 200 cm	10,50
	N186.000.0025	Adjustment spindle for Modular panel support	3,10
	N186.000.0034	Adjustment unit for panel support LOGO cpl.	5,10
	N186.003.0006	Clevis shoe M30 cpl.	12,90

Climbing platform KBK 180

	N154.000.1800	Climbing platform KBK folding 180x300 cm cpl.	351,00
	N154.000.1810	Climbing platform KBK folding 180x300 cm cpl. with trap	370,00
	N154.000.1802	Climbing platform KBK fold. for corners 180x390 cm cpl. right	360,00
	N154.000.1803	Climbing platform KBK fold. for corners 180x390 cm cpl. left	360,00

Subject to technical changes

18  
19  
20  
21  
22

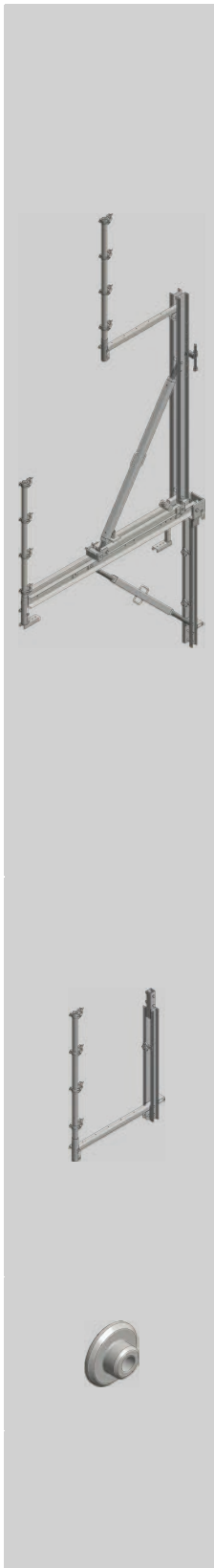

## Parts list

	Art.-N°	Item	kg		Art.-N°	Item	kg	
	N186.003.0014	Suspending scaffold 300 cm KBK cpl. (up to 3.75 m height)	165,00		N153.000.0001	<b>Dam bracket SPK270</b> cpl. max. inclination 38°	434,00	
	N186.003.0029	Suspending scaffold 300 cm KBK cpl. (up to 5 m height)	179,12		N186.002.0010	Horizontal beam 270 cm mount. for SPK 270	97,50	
	N186.003.0025	Extension KBK 180x300 cpl.	114,20		N186.002.0011	Vertical beam 200 cm mount. for SPK 270	53,50	
	N186.003.0000	Climbing platform KBK 180 cm folding	125,00		N186.002.0012	Push pull prop 155-235 cm for SPK 270	37,50	
	N186.003.0015	Suspending scaffold KBK (up to 3.75 m height)	52,50		N186.002.0013	Running cart mount. for SPK 270	50,50	
	N186.003.0030	Suspending scaffold KBK (up to 5.00 m height)	59,50		N186.002.0014	Vertical girder 290 cm mount. for SPK 270	94,00	
	N186.003.0026	Extension KBK bracket cpl.	57,10		N186.002.0015	Push pull prop 135-290 cm for SPK 270	44,50	
	N186.003.0006	Clevis shoe M30 cpl.	12,90		N186.002.0016	Fastening running cart mount. for SPK 270	14,50	
	N186.003.0005	Connecting piece for clevis shoe cpl.	6,00		N186.002.0017	Guard rail 200 cm for SPK 270	14,00	
	N186.003.0004	Connecting piece for drop-in loop. KBK cpl.	4,60		N186.002.0018	Jackscrew for SPK 270	4,00	
	N189.000.1021	Clamping piece (up to 60cm) lateral protection Secuset	5,10		N186.002.0019	Platform bracket 120 cm mount. for SPK 270	10,00	
	N189.000.1001	Railing post 120 cm lateral protection Secuset	3,20		N186.002.0001	<b>Suspended scaffold up to 300 cm for SPK 270</b> consisting of:	60,00	
	N189.000.1010	Support for toe board lateral protection Secuset	0,46		N186.002.0020	Vertical beam suspended scaffold for SPK 270 mount.	36,00	
						N186.002.0019	Platform bracket 120 cm mount. for SPK 270	10,00
						N186.002.0017	Guard rail 200 cm for SPK 270	14,00
				N186.002.0002	<b>Suspended roller D.115</b>	1,30		

Subject to technical changes

## Parts list

Lifting platforms

	Art.-Nr.	Bezeichnung	kg
	N186.001.0005	End piece 72,5(86,5) cm for klik-klak beam	46,00
	N186.001.0004	End piece 49(61) cm for klik-klak beam	38,00
		Centre piece for klik-klak beam	
	N186.001.0009	10 cm	13,00
	N186.001.0010	20 cm	15,50
	N186.001.0015	50 cm	23,50
	N186.001.0020	100 cm	37,00
	N663.401.0001	Head plate 2 cm for klik-klak beam	5,50
	N186.001.0031	Support bracket d.32 for klik-klak beam	10,00
		Support bracket d 32mm/45° for klik-klak beam	
	N186.001.0032	right	11,50
	N186.001.0033	left	11,50
		Hexagonal screw DIN 933 10.9	
	N900.933.1403	M 20 x 60	% 20,00
	N900.933.1405	M 20 x 80	% 24,00
	N900.933.1407	M 20 x 100	% 28,00
	N900.933.1408	M 20 x 120	% 32,00
	N900.125.0010	Washer B 21 DIN 125 galvanized	% 1,70
	N900.934.1920	Hexagon nut M20 DIN 934/10	% 6,40
	N900.603.0031	Pan head screw M12 x 180 w. nut DIN 603, galvanized	% 19,30
	N900.125.0006	Washer B13 DIN 125, galvanized	% 0,60









	Art.-Nr.	Bezeichnung	kg
	N186.000.0050	Anchor cone M30/DW15 x 105	1,00
	N186.000.0051	Nail plate M30	0,20
	N189.018.0054	FB closure cone for Anchor cone M30/DW15	0,30
		Anchor plate tie bar with thread grooves	
	N186.000.0059	D=100-100	0,80
	N186.000.0060	D=100-150	0,85
	N186.000.0061	D=100-200	0,92
	N186.000.0062	D=100-250	0,99
	N186.000.0063	D=100-300	1,06
	N186.000.0064	D=100-350	1,13
	N186.000.0065	D=100-400	1,20
	N186.000.0066	D=100-450	1,27
	N930.007.0042	Sealing ring D.21 x 14,5 x 3 EPDM	0,01
		Hexagonal screw DIN 933 (93)/8.8	
	N900.933.1701	M30 x 60	0,54
	N900.933.1702	M30 x 70	0,59
	N900.933.1704	M30 x 90	0,76
	N900.933.1706	M30 x 110	0,87
	N186.000.0052	Special key SW 41/46	1,50
	N940.014.0002	Screw anchor M24 x 280	1,09
	N940.014.0003	PVC screw insert M24	% 1,00
		Hexagonal screw DIN 933/8.8	
	N900.933.1601	M24 x 45	% 26,00
	N900.933.1603	M24 x 60	% 30,00

Subject to technical changes



## Parts list

Fastening material

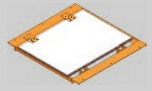
	Art.-Nr.	Bezeichnung	kg
	N900.125.0011	Washer B 25 DIN 125 galvanized	% 3,00
	N940.014.0011	PVC - plug M24	% 0,20
	N940.014.0018	Socket spanner for screw insert M 10 - M 30	0,20
	N940.014.0008	Special key M24	2,20
	N940.014.0020	Screw anchor M36x430	4,30
	N900.933.1802	Hexagonal screw DIN 933/8.8 M36x90	1,07
	N186.002.0003	Special key M36 for SPK 270	5,50
	N186.003.0008	Drop-in loop KBK D. 10x500 mm	0,40
	N186.002.0037	Fixation tension belt, mounted	1,80
	N940.100.0107	Tension belt 5,0m with ratchet and carabiner	3,00
	N286.000.0012	Trap for climbing bracket and klik-klak beam 60x62cm	19,00

	Art.-Nr.	Bezeichnung	kg
	N189.004.0043	Steel ladder 40/220cm cpl.	12,00
	N189.004.0044	Bottom ladder extension 40/95cm cpl.	7,00
	N189.004.0045	Bottom ladder extension 40/63cm cpl.	5,00
	N189.004.0046	Connection ladder 40/220cm cpl.	2,50
	N187.500.0111	Ladder fastening steel ladder for L/A	9,70
	N189.004.0083	Ladder fixation top cpl.	1,00
	N189.004.0085	Ladder fixation bottom cpl.	1,50
	N189.004.0047	Ladder cage 97cm for steel ladder 40/220 cm	9,00
	N287.500.0100	Clamping device for ladder cage cpl.	4,00
		Tube EN39 galvanized	
	N652.021.3000	Ø 48,3 x 3,25 x 3000	10,80
	N652.021.3500	Ø 48,3 x 3,25 x 3500	12,60
	N652.021.4000	Ø 48,3 x 3,25 x 4000	14,40
	N652.021.4500	Ø 48,3 x 3,25 x 4500	16,20
	N652.021.5000	Ø 48,3 x 3,25 x 5000	18,00

18  
19  
20  
21  
22

Subject to technical changes

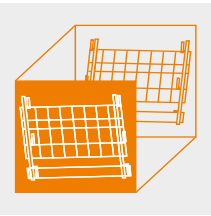

# Secuset





## Reliable lateral protection in accordance with DIN EN 13374

Occupational safety on construction sites is the top priority for PASCHAL!

Therefore the new professional lateral protection system Secuset complies with the latest safety standard DIN EN 13374, thus making a significant contribution to smooth and safe construction workflows.

### **A post to meet all needs**

The lateral protection system can be used for a number of applications with various connection pieces (for wall formwork, slab formwork, at windows and doorways, on concrete slabs, at free slab edges and on wall tops). Thanks to the solid click method, the lateral protection posts can be attached particularly easily and safely.

## Reliable lateral protection

### Lateral protection post

A key element is the railing post lateral protection, which can be used for almost unlimited applications when combined with various connecting parts. Thanks to the flexible application of the lateral protection system, you will save on investment, transport and storage costs.



Secuset with lateral protection fence on LOGO.3

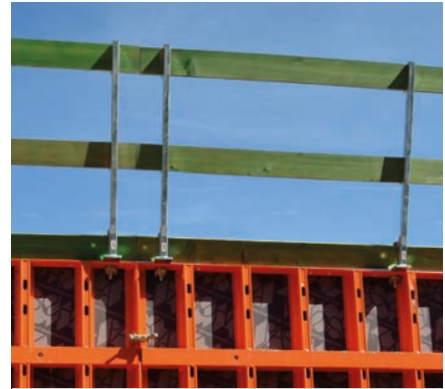

Secuset with wooden boards on LOGO.3 formwork

### Easy and fast assembly

Thanks to the solid click method, the lateral protection posts can be attached particularly easily and safely. Due to the self-explanatory, logical setup, the lateral protection is quick and safe to assemble and ready for immediate use.

- Highest security - Secuset corresponds to the current security standard DIN EN 13374
- Versatile use - for wall formwork, slab formwork, at windows and doorways, on concrete slabs, at free slab edges and on wall tops
- Easy and fast assembly - thanks to the solid click method
- Can be used both with fence or boards
- Long service life - all the components of the fall protection system are hot-dip galvanized and meet the highest quality standards



Use on slab formwork with clamping piece



Secuset with lateral protection fence on NeoR





## Lateral protection on the edges of concrete slabs

In combination with the fastening plate, the lateral protection system offers comprehensive fall protection, for example, on the edges of concrete slabs. The four support points on the underneath of the fastening plate ensure a secure installation surface. The large fixing hole also allows for extremely quick and easy mounting.

*The lateral protection post is mounted at the slab edge using the fastening plate*



*Lateral protection clamping piece and protection fence*

## Lateral protection on slab formwork, slab edges or parapet walls

With an impressive wide adjustment range of up to 60 cm, the lateral protection clamping piece can be used in many ways, and can be mounted both vertically and horizontally. It encloses a component edge and is clamped securely via an integrated DW15 thread with a wing nut.

23



*The lateral protection clamp with a clamp width of up to 60 cm is especially suitable for use in slab formwork.*

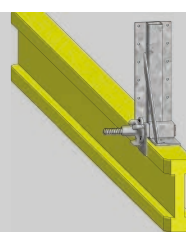
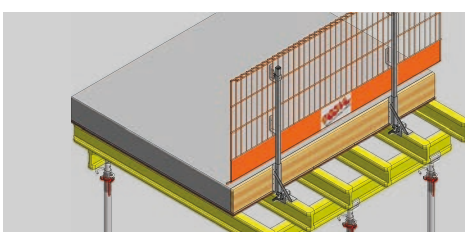

*The edge stop H20 is used for slab edge or beam formwork. At the same time, it can connect the Secuset post to an H20 beam.*

## Lateral protection on formwork

Safe workplaces must be established at the top end of the formwork to fill and compact the concrete. On the opposite side, further lateral protection provides the necessary fall protection.

With Secuset, the 230 x 80 cm lateral protection fence with wooden toe board can be used on the formwork. To create space for the crane mounting during relocation, the toe board is inserted securely in the central board support for transportation purposes. In this way, it is available for use again in its initial position directly after the relocation process.

As an alternative to the lateral protection fence, boards can also be mounted in the lateral protection posts.



## Connecting pieces for PASCHAL formwork systems

Supports are available for our Modular, GE and LOGO formwork systems to accommodate the lateral protection posts with boards or fences.



23



Lateral protection NeoR support



Lateral protection Modular support













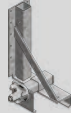





Lateral protection GE support



Lateral protection LOGO support

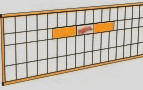

Parts list

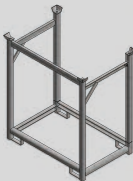
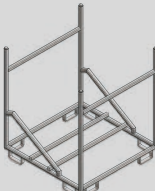
	Art.-N°	Item	kg		Art.-N°	Item	kg
	N189.000.1020	Fastening plate lateral protection Secuset	1,42		N189.000.1022	Edge stop H20 Secuset	4,15
	N189.000.1001	Railing post 120cm lateral protection Secuset	3,20		N189.000.0003	LOGO platform bracket Secuset	9,40
	N189.000.1010	Support for toe board lateral protection Secuset	0,46		N189.000.0040	NeoR bracket lateral protection Secuset	8,20
	N189.000.1011	Support for protection fence Secuset	0,21		N189.000.0011	Modular platform bracket 90 cm Secuset cpl.	7,98
	N189.000.1021	Clamping piece (up to 60cm) lateral protection Secuset	5,10		N189.000.1023	Clamping piece for sheet pile Secuset	1,40
	N189.000.0001	Support LOGO cpl. lateral protection Secuset	3,10		N189.000.1024	Wall support lateral protection Secuset	1,70
	N189.000.0041	Support NeoR cpl. lateral protection Secuset	2,90		N189.000.1030	Lateral protection fence 260 cm Secuset	19,80
	N189.000.0010	Support Modular cpl. lateral protection Secuset	2,00		N189.000.1035	Lateral protection fence 230x80cm Secuset	10,10
	N189.000.0020	Support GE cpl. lateral protection Secuset	5,20		N189.000.1036	Lateral protection fence 130x80cm Secuset	6,60
					N189.000.1040	Pallet for lateral protection fence Secuset (for 25 pce.)	60,00
					N189.000.1041	Pallet for lateral protection fence Secuset (for 60 pce.)	83,00

Subject to technical changes



# Multip

Multi-functional working-platform





## Technical data

<b>Multip</b>		
Admissible load		2,0 kN/m <sup>2</sup>
Board width	LOGO.3	72 cm
	Trapezoidal Girder Formwork	85 cm
Board length	LOGO.3	238 cm, 133 cm
	Trapezoidal Girder Formwork	External 238 cm (D ≥ 7.00 m) · Internal 210 cm (D ≥ 7.00 m)
Door		Stop end
Platform extension		Bridging of filler panels (15, 30, 45, 60 cm)
Trap		Integrated in the board
Ladder		Access to different levels

## Safety at work/ Efficiency

The economic efficiency of a formwork system depends on numerous factors. The size of the formwork elements, the number of accessories and the ability of the system to be adapted to a range of ground plans all have a decisive influence on whether the labour costs can be kept under control.

As a rule, little attention is paid to the importance of the jobs on the formwork. It's true that some individual platform brackets or scaffolding platforms are available as system parts, but these have to be completed with pieces supplied by the customer. This tends to take up a relatively long time and moreover, results frequently fail to match existing regulations and guidelines regarding health and safety at work.

However, if you combine the PASCHAL formwork systems with Multip, the multi-functional working platform, this complete system comprising both formwork and scaffolding provides even better forming times, combined with the necessary working safety.

Because the basis of this complete system is ready platforms made of steel with integral guard rail, suitable to the width of the large formwork elements. After a one-time-only pre-assembly, however, these always remain attached to the element, and can be transported together with it, as they are designed to fold away. This does away with the repeated need to assemble and dismantle individual platforms and loose sheets of flooring. A further advantage lies in the fact that all work on the formwork can be carried out in safety. Attaching and dismantling crane lifting clamps, fixing and loosening of prestressing anchors and fasteners or fixing an additional waler are carried out from safe and secure working positions more quickly, and thus the forming time needed is further reduced.



Medicalcenter, F-Beinheim; KNOLL Sarl, F-Beinheim



Drinking water treatment plant Montry, F-Montry ;  
Gagneraud Construction, F-Sarcelles



Extension of the Centre Hospitalier, F-Erstein;  
EIFFAGE CONSTRUCTION, F-Strasbourg



Composting plant, F-Pfaffenhofen; Krummhorn Sarl., F-Bitschoffen



## Pre-assembly only once for frequent use:



Ready-assembled units of formwork with working platforms are ready for transport.



After pre-assembly or unfolding the platforms, the formwork is placed together with stages and props.

With effortless ease brackets, platforms, doors and props can be fitted to the formwork elements on the ground. Then the formwork together with the scaffolding is lifted into place for its first use with just a single crane cycle, and is just as simply moved on for following concreting sections. And not a single piece must be detached and refitted.

Advantage can be taken of this feature for several building sites too. Once they are assembled, guard rails, platforms and brackets only need plugs on the formwork element to be loosened, and they can be folded together. This way, it is possible to transport the formwork to the next building site with the scaffolding still in place, and unfold it ready for its next use. This means that all the parts are already there where they belong, and no time has to be wasted looking for them and assembling them.

Have you already seen it?



Watch the video to see how simple you can assembly Multip on our wall formwork LOGO.3. It's worth taking a look!

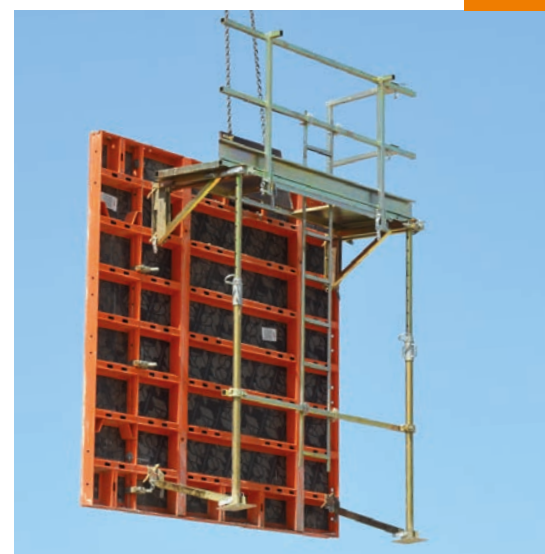

Moving the formwork with Multip



## Large-size formwork

Even where a great formwork height is required, the combined formwork element and assembled working platforms units can be fitted on top of one another without difficulty. Integral ladders and access hatches make all levels easy to reach. Additional doors on the face complete the guard rail and fixing the large props behind the brackets creates the space necessary in the safety of the working area to be able to carry out all the work in that area such as fitting or loosening fasteners, ties etc.

*Access hatches and ladders make it possible to get up to the next level. This is necessary after setting and anchoring the formwork, in order to remove the crane clamps and to enable the crane to be released quickly.*

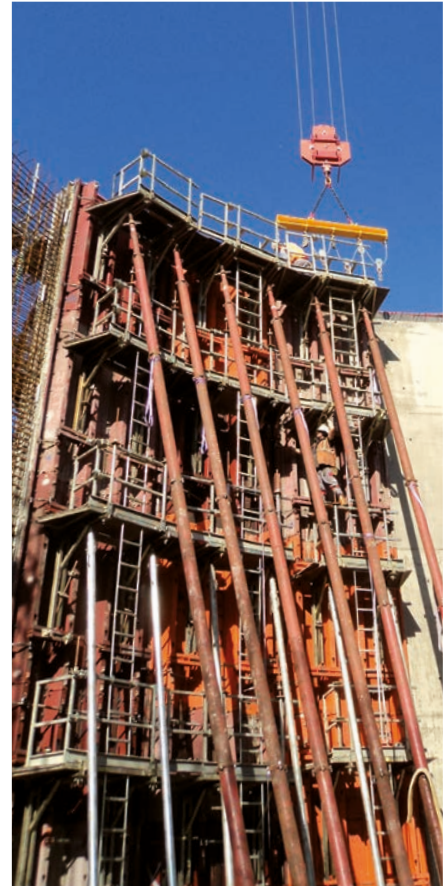

*Sewage basin, Schirrhein, France;  
Dumez Anstett S.A., Mundolsheim, France.*

24



*Retention basin, F-Besançon; Pertuy Construction,  
F-Wolfisheim*



*Hospital, F-Strasbourg; Eiffage Construction Alsace, F-Oberhausbergen*



## Compensations



PASCHAL also supplies a system for designing safe workplaces and thus efficiency, as the platforms and the guard rails can be suited to varying geometry or ground plans.

If using the LOGO or Athlete wall formwork, the working platform can be extended with extension pieces so that it is possible to form with the large-size elements either standing or lying down, or to bridge smaller elements.

For the circular Trapezoidal Girder Formwork, extensions are already integrated into the platform. A further door can be fixed to a door e.g. for use as a stop end.

This means:

- Formwork and working platform can be transported already assembled
- Repeated assembly of a number of individual brackets is no longer necessary
- Time profit by folding mechanism
- Safe and accordingly quicker operation with all system components
- Much longer service life than timber decking
- Purchase of timber for decking and guard rail is no longer necessary
- All safety at work directives are covered

24

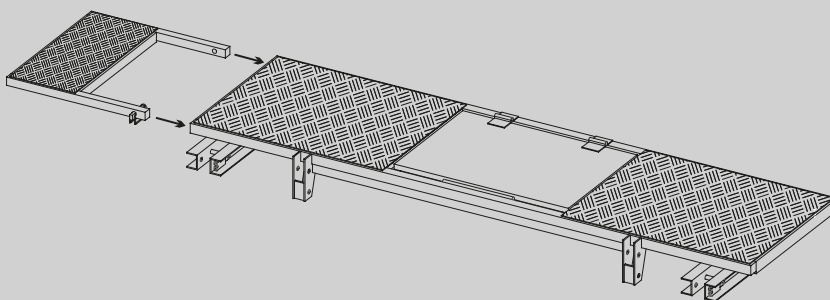









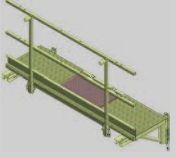



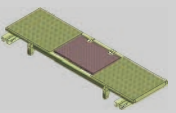
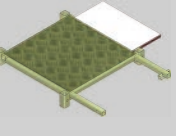

extending the platform

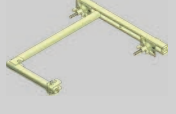
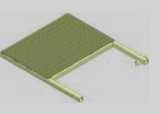

Doors as extension

## Parts List

	Art.-N°	Item	kg		Art.-N°	Item	kg		
	N187.500.0085	Working platform cpl. for Multip L/A 70 / 240 cm	133,80		N187.500.0062	Foot plate cpl. for Multip L/A	3,02		
	N187.500.0086	70 / 135 cm	96,40			N187.500.0061	Support below 82 cm for Multip L/A	4,00	
	N187.500.0058	Guard rail cpl. for Multip L/A 240 cm	38,04			N187.500.0060	Suspending piece for props 70 mm cpl. for Multip L/A	2,00	
	N187.500.0077	135 cm	26,04			N187.500.0064	Ladder fastening prop cpl. for Multip L/A	12,50	
	N187.500.0056	Platform cpl. for Multip L/A 70 / 240 cm	75,48			N187.500.0094	Platform extension 60 cm cpl. for Multip L/A	26,50	
	N187.500.0076	70 / 135 cm	50,08			N187.500.0095	Guard rail 60 cm cpl. for Multip L/A	20,50	
	N187.500.0057	Diagonal cpl. for Multip L/A	3,14			N187.500.0093	Compensation bracket 70 for Multip L/A	8,52	
		N187.500.0055	Platform mounting bracket for platform for Multip L/A		7,00		N187.500.0104	Ladder fastening at panel for Multip L/A	10,50
		N187.500.0070	Platform extension cpl. for Multip L/A 15 cm	7,50			N187.500.0108	Guard rail extension for Multip L/A 240 cm	31,80
		N187.500.0069	30 cm	11,00					
	N187.500.0068	45 cm	14,50		N187.500.0059	160 - 280 cm	10,50		
	N187.500.0087	Support cpl. for Multip L/A 160 - 280 cm	17,52				N187.500.0078	280 - 390 cm	17,00
	N187.500.0088	280 - 390 cm	24,02						



## Parts List

	Art.-N°	Item	kg		Art.-N°	Item	kg
	N187.500.0121	<b>Front protection</b> cpl. for Multip L/A 240 cm	42,40		N182.000.0292	<b>Front protection</b> cpl. for Multip T 230/240 cm	44,90
	N187.500.0128	135 cm	36,00		N182.000.0293	115/120 cm	41,20
	N187.500.0126	<b>Support to Multip</b> for front protection 135/240 cm L/A	2,00		N182.000.0287	<b>Support for front</b> <b>protection T</b> left	3,70
	N187.500.0127	<b>Support to LOGO</b> <b>panel</b> for front protec- tion 135/240 cm L/A	1,80	N182.000.0288	right	3,70	
	N187.500.0124	<b>Scaffold tube longit.</b> 212,6 cm for front protection 135 / 240 cm L/A	8,00		N182.000.0289	<b>Longitudinal scaffold</b> <b>rail</b> for front protec- tion T 11,00	11,00
	N187.500.0122	<b>Cross tube</b> 230 cm for front pro- tection 240 cm L/A	9,40		N182.000.0290	<b>Cross scaffold rail</b> for front protection T 214 cm	8,00
	N187.500.0123	125 cm for front pro- tection 135 cm L/A	6,00		N182.000.0291	110 cm	4,30
	N182.000.0271	<b>Working platform</b> 85 x 238 cm external cpl. for Multip T	133,00		N187.500.0065	<b>Door 60/105 cm</b> cpl. for Multip L/T/A	11,50
	N182.000.0272	<b>Working platform</b> 85x210 cm external cpl. for Multip T	129,00		N187.500.0066	<b>Door extension.</b> cpl. for Multip L/T/A	4,00
	N182.000.0256	<b>Platform fastening</b> for Multip T	1,80		N187.500.0074	<b>Ladder fastening</b> <b>guard rail</b> cpl. for Multip	2,00
	N182.000.0270	<b>Suspending device</b> cpl. for Multip T	55,00		N187.500.0063	<b>Ladder</b> cpl. for Multip 260 cm	12,00
	N182.000.0257	<b>Ladder fastening</b> for Multip T	11,00		N187.500.0071	130 cm	7,00

Subject to technical changes

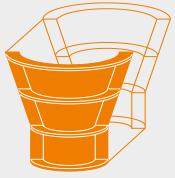

# GASS

Aluminium shoring system





## Technical data

GASS		
Max. load per leg		140 kN
Aluminium legs		140/249/358/467 cm
Aluminium extension legs		140/249/358/467 cm
Inner leg		78/168 cm Height adjustment · Calibration
Ledger frame		120/180/240/300 cm · Height 100 cm · Stiffening
Stiffening beam 400		Leg connection at 40 cm for derivation of extreme loads
Platform bracket		93/120 cm with guard rail post
Cross girder beam		120/180/240 cm length for support of beams
Trolley unit cpl.		Transport possibility for application as table form
Scaffold board		180/240/300 cm as working platform mounted to the frame
Aluminium beam	Length	180/240/300/360/420/480/540/600/720 cm as main girder
	Height	22,5 cm
Head plate, foot plate pivoted		As foot plate between inclined ground and leg; as head plate between leg and inclined main girder (for inclined slabs)

## Remain flexible

For the support scaffolding sector PASCHAL offers GASS; which is made of aluminum and allows the distribution of static loads from great heights.

## GASS = Great aluminium shoring system

GASS is a further development of the commercially available aluminium shoring systems. With a maximum safe working load of up to 140kN per leg, this is the aluminium shoring system with the greatest load-carrying capacity. This result is from the stable legs consisting of high-strength aluminium and the stiffening frame, which produce the stiffness of the whole system. Compared to other systems, GASS has a far higher load-carrying capacity, thus reducing the number of required legs and stiff-ening frames considerably. The 1 m high frames and the access platforms mean that the system is easy to erect and simple to handle. The access platforms can be suspended from the lower tube of the frames.

The round cross section of the legs is the ideal statical form for absorbing large forces with minimal material. The longitudinal slots in the leg makes it possible to connect to the frame in 45° steps. In this way, the shoring system can be adjusted to any required layout. The identical head and foot plates have a chequered surface with a 2 mm profile. When assembling legs and jacks, a precise positive connection is achieved. As a result, the screwed union of head and foot plates is always exact and a perfect fit. In the bolted connection, there are only tensile forces; lateral forces are taken up by the denticulation.

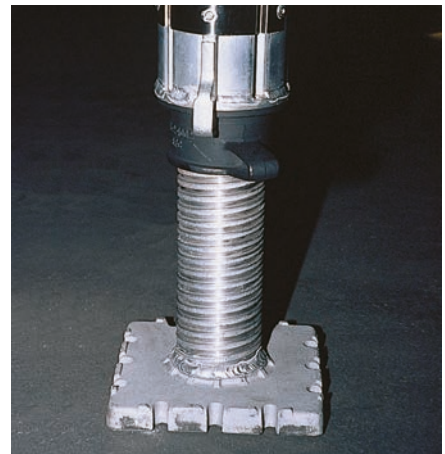
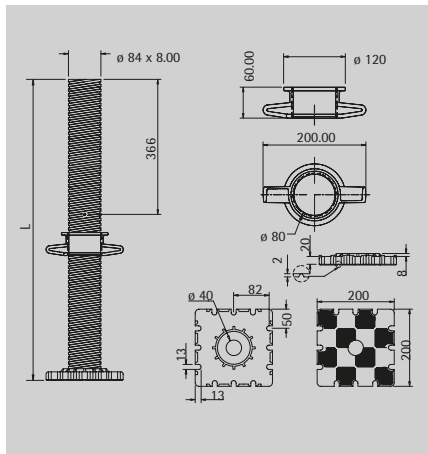
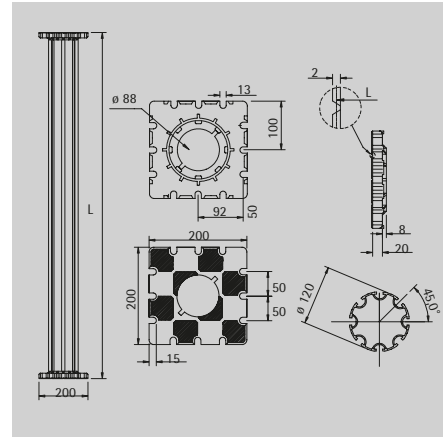
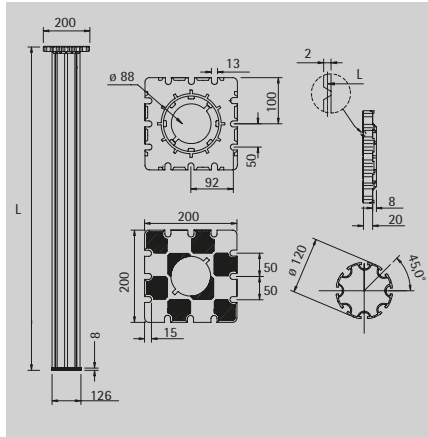

Retention reservoir, Wolterdingen; Emil Steidle GmbH & Co. KG, Sigmaringen





Lock chambre, F- Igney; SETHY ,F-Metz Actipôle

Two different jacks are available for variable jobsite applications and required height adjustment. The short jack is 78 cm long and can be adjusted from 10 to 40 cm. The large jack is 168 cm long and can be adjusted from 10 to 130 cm. The end point of the wing nut is fixed with a locking pin to prevent over extension. The latch on the leg connects leg and jack. A jack can be assembled to the headplate and footplate of a leg.

One unique, user-friendly and structurally progressive feature is the possibility of connecting and combining legs and jacks at random. This has the inestimable advantage that the GASS aluminium shoring system helps the customer to execute even the most difficult support structures.

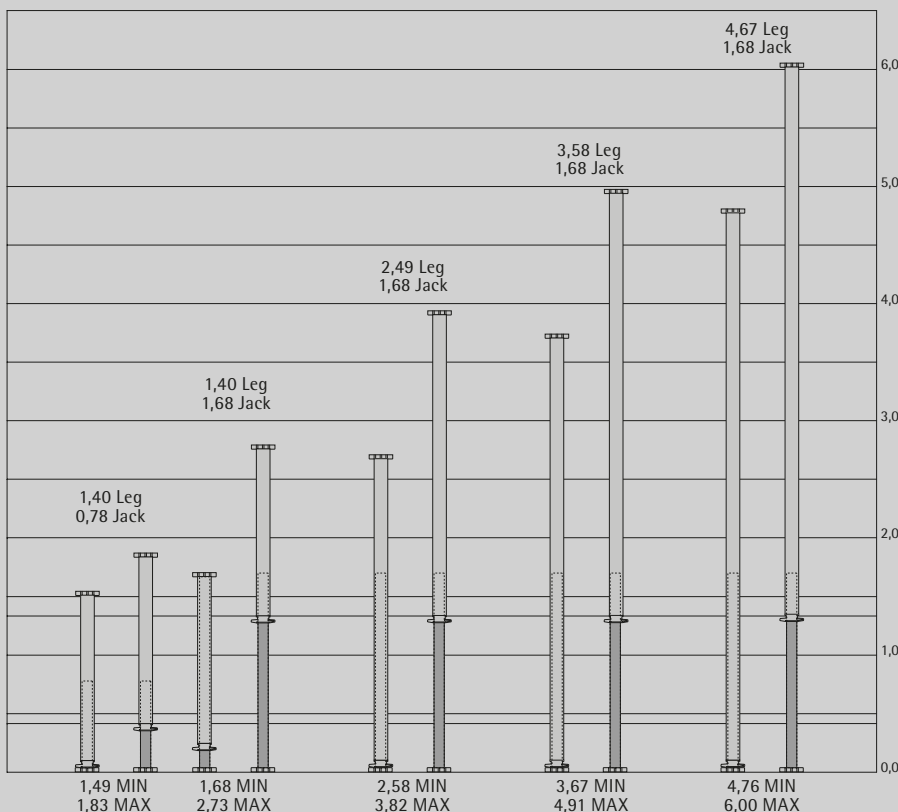

## The legs:

The legs and the two different jacks can cater to supports in any heights as from 1,49 m. Supports up to 12,00 m in height only require two spindle props. Additional extension legs with two end plates are used for greater heights.

There are altogether four different frames available for axis dimensions of 1,20, 1,80, 2,40 and 3,00 m for ideal adjustment of the shoring system to the layout. The hook headed bolt acts as positive connection between frame and outerleg. The easy-to-use structure of the frames means that they can also be assembled over and beyond the outerleg connections. Even the largest frame which is designed like trelliswork only weighs 14 kg; the largest of the four legs weighs only 22 kg. The system parts can therefore be easily transported and assembled by one single person.



Production hall, D-Endingen; Ernst Späth, D-Endingen

### The ledger frames:

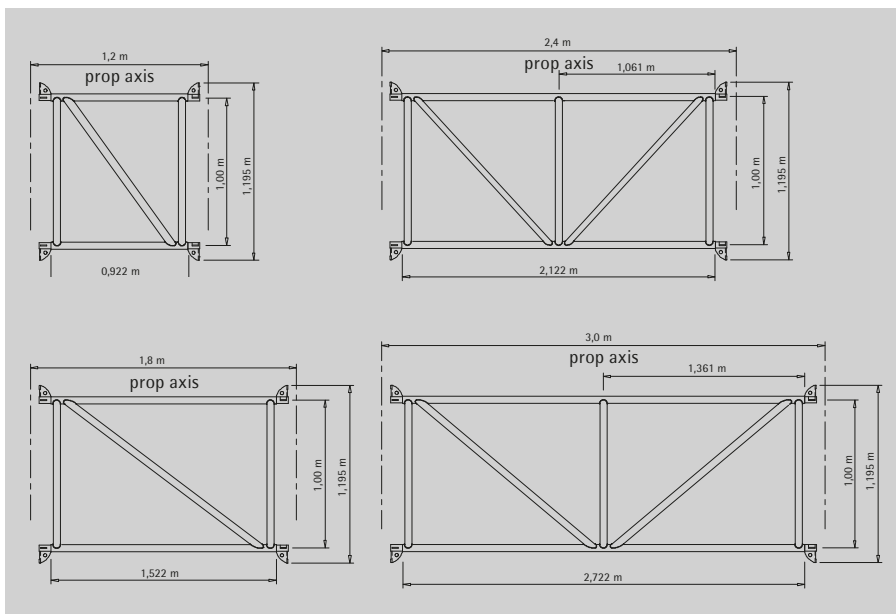

The turning mechanism of the hook headed bolt in combination with a wedge means that one person can assemble every frame size without additional help. The wedge is knocked firmly into place for a strong connection. This is indicated by the horizontal position of the wedge, so that simple visual control of the system is possible.

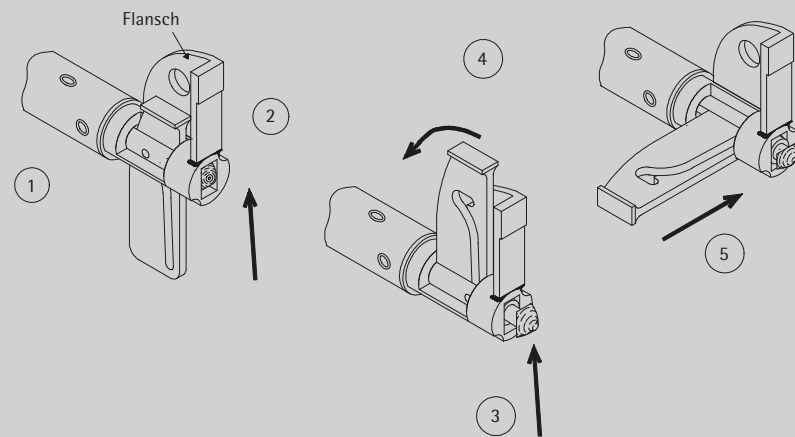





Traffic tunnel, high-speed railway line Tours-Bordeaux; Vinci Construction, F-Nanterre

The convincing feature of the GASS aluminium shoring system is its high load-carrying capacity. This means that altogether fewer props and other system components are required. The comparatively small number of system parts needed in this way results in time savings during assembly and dismantling. Thanks to the simple and rapid handling and easily understood assembly of the system, this system is very fast to erect. Consequently it saves working time. The individual system components can be combined to make GASS an extremely flexible system.



Extension of existing production hall; Bauunternehmen Daume GmbH, D-Gilserberg



Footbridge, CZ-Bílina; Betonstav, CZ-Teplice





## The short link:

If heavy loads have to be discharged in constricted space, then additional props are necessary. The short link 400 can connect these additional legs for example to an existing tower.

Your advantages:

- Greatest load discharge  
→ therefore less material
- Easy erection procedures  
→ therefore faster assembly
- Low weight thanks to aluminium structure
- Combination possibilities for a flexible system

## The arrangement of the frames:

Another advantage of the frame design is that the frames can also be fitted over and beyond leg connections. This is very important when calculating the number and arrangement of the frames. The spacing between two frames should not exceed 1,50m to guarantee safe erection of the system.

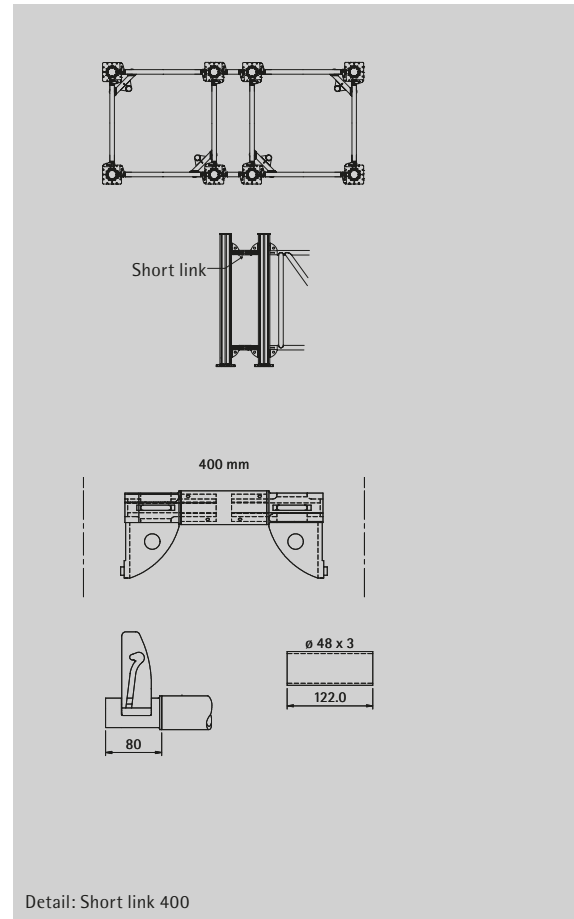
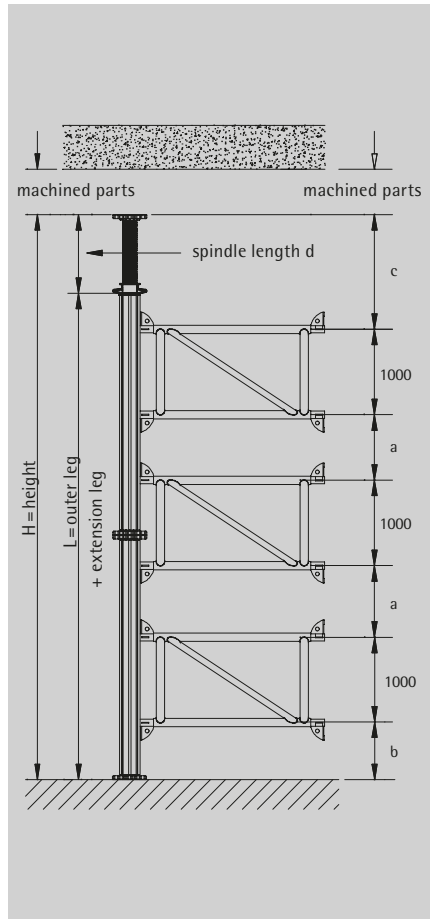

Detail: Short link 400



New building Hewe-Fensterbau, D-Lahr; Baugesellschaft Eichner mbH, D-Lahr



## The main beam:

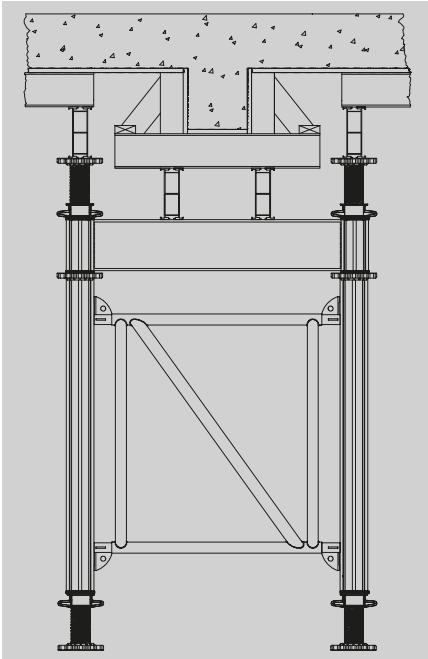

In the GASS aluminium shoring system, the main beam is a 22,5cm high aluminium beam, whose static values (tolerable shearing force, tolerable bending moment, moment of inertia) are coordinated with the whole system. Alu beams are available in lengths from 1,80 m to 7,20 m to meet the many different requirements on the job site.

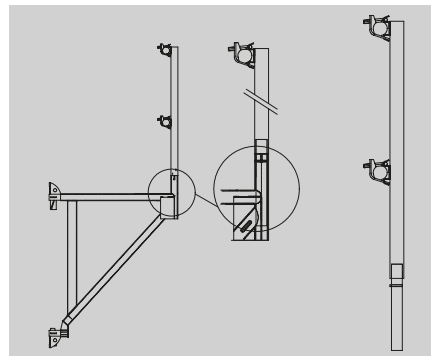

## The saddle beam:

Another important component in the GASS aluminium shoring system is the saddle beam. Assembled on the legs, this serves primarily to form and concrete the beams together with the slab, or to support finished parts.













## The platform brackets:



GASS cantilever brackets are extremely useful. Their cantilever overhang is 1,20 m and they are rated for a vertical load of up to 12 kN each. When used as scaffold or platform brackets, these components guarantee safe working, for example at the edge of slabs. If a spindle is used instead of a handrail post, then projections of up to 2,00 m can be supported.



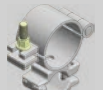









Renovation of lock chamber, D-Lauffen; Schleith GmbH & RSW RoBlauer Schiffswerft GmbH & Co KG

## Parts list

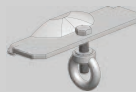
	Art.-N°	Item	kg		Art.-N°	Item	kg	
		<b>GASS outer leg</b>				<b>Tube D.48, 3 x 3,25</b>		
	N940.032.1075	75 cm	5,80		N652.021.1000	100 cm	3,60	
	N940.032.1140	140 cm	8,04		N652.021.1500	150 cm	5,40	
	N940.032.1249	249 cm	12,73		N652.021.2000	200 cm	7,40	
	N940.032.1358	358 cm	17,41		N652.021.2500	250 cm	9,00	
N940.032.1467	467 cm	22,10	N652.021.3000	300 cm	10,80			
				N652.021.3500	350 cm	12,60		
				N652.021.4000	400 cm	14,40		
				N652.021.5000	500 cm	18,00		
				N652.021.6000	600 cm	21,60		
		<b>GASS extension leg</b>				<b>GASS cantilever support bracket</b>		
	N940.032.2075	75 cm	6,70		N940.032.9002	93 cm	3,00	
	N940.032.2140	140 cm	9,54	N940.032.9001	120 cm	4,00		
	N940.032.2249	249 cm	14,23					
	N940.032.2358	358 cm	18,91					
N940.032.2467	467 cm	23,60						
		<b>GASS inner leg</b>			N940.032.9003	<b>GASS handrail post 108 cm</b>	5,50	
	N940.032.3078	78 cm	6,60					
N940.032.3168	168 cm	11,30						
		<b>GASS ledger frame</b>			N930.002.0002	<b>Normal coupler d.48 SW19 hot-dip galvanized</b>	0,55	
	N940.032.4120	120 cm	8,10					
	N940.032.4180	180 cm	9,90			N930.002.0004	<b>Rotary coupler d.48 SW19 hot-dip galvanized</b>	1,10
	N940.032.4240	240 cm	12,90					
N940.032.4300	300 cm	14,20						
		<b>GASS alu beam</b>			N183.002.0002	<b>Leg bracing collar</b>	1,45	
	N940.032.8180	180 cm	16,10					
	N940.032.8240	240 cm	21,40		N183.002.0009	<b>Jack bracing collar</b>	1,50	
	N940.032.8300	300 cm	26,80					
	N940.032.8360	360 cm	32,00					
	N940.032.8420	420 cm	37,50					
	N940.032.8480	480 cm	42,90					
	N940.032.8540	540 cm	48,20					
	N940.032.8600	600 cm	53,50		N183.002.0021	<b>Rotary coupler for props</b>	1,00	
N940.032.8720	720 cm	64,20						

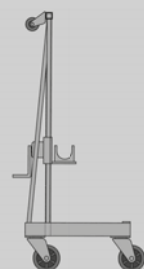
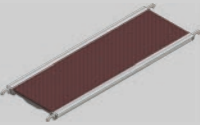
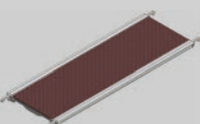

## Parts list

	Art.-N°	Item	kg		Art.-N°	Item	kg
	N940.032.9031	GASS short link 400	2,00		N183.001.0003	Connecting piece wooden girder H20/H20	0,75
	N940.032.9032	GASS spanner galvanized	5,40		N183.002.0005	Connection piece leg/alu beam	0,30
	N183.002.0017	Appendage for spanner	3,00		N183.002.0004	Connecting piece leg/leg	0,25
		GASS saddle beam			N183.002.0012	Connecting piece prop/spindle	0,83
	N940.032.6120	120 cm	10,70		N940.032.9070	GASS pallet	67,00
	N940.032.6180	180 cm	16,10		N940.033.9001	Titan Trolley	84,00
	N940.032.6240	240 cm	21,40				
		GASS access platform					
	N940.032.7180	180 cm	16,70				
	N940.032.7240	240 cm	19,00				
	N940.032.7300	300 cm	22,80				
		GASS working platform					
	N940.032.9010	60 x 180 cm	12,50				
	N940.032.9011	60 x 240 cm	17,50				
	N940.032.9043	GASS trolley unit cpl. max. 2413	28,50				
	N183.002.0007	Rocking base/head plate	9,20				
	N183.002.0001	GASS clamping piece H 20/alu beam	0,50				

Subject to technical changes

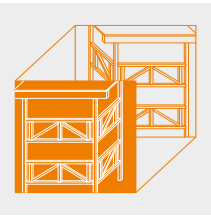

# PASCHAL TG 60

Shoring system





## Shoring

As defined by DIN EN 12812, shoring is a temporary structure to support the parts of a structure, including the associated live loads, as long as these parts are not themselves sufficiently strong and stable. Shoring structures are assembled from individual components at their place of use and are dismantled again once they have fulfilled their purpose.

Shoring structures are primarily used

- To support formwork until the concrete has reached a sufficient level of strength and stability
- To absorb the temporary loads imposed by components or equipment during extension, conversion or maintenance work.
- As an additional supporting structure during the temporary storage of materials or construction parts.

The term "shoring structure" comprises all the parts from the top edge of the formwork down to the grounding that are in any way related to the load-bearing structure that is to be supported.

It must be possible to access the shoring structure and the formwork that is to be supported via secure access routes.

\*The TG 60 shoring frame described below is a product of the Wilhelm Layher GmbH & Co KG. The texts are taken from the technical information provided by Layher.

## Assessment

The TG60 is generally used as the sub-structure for classic wooden girder formwork. Unlike PASCHAL Deck slab formwork, yokes made of H20 beams are designed as double yokes. The cross and yoke beams as well as the tower dimensions are distributed based on static requirements. Depending on the case, different components of the shoring system may be relevant for dimensioning. Individual resistance values can be found in the type statics in the "Instructions for setting up and using the shoring tower TG 60" (see also "H20 beams" in the chapter on PASCHAL Deck).



Gare Pont Rouge, L- Luxembourg; Consortium „TRALUX and Lux TP S.A.“, L- Luxembourg



## Reinforcement scaffolding

B = 73 cm, can be handled by crane

26

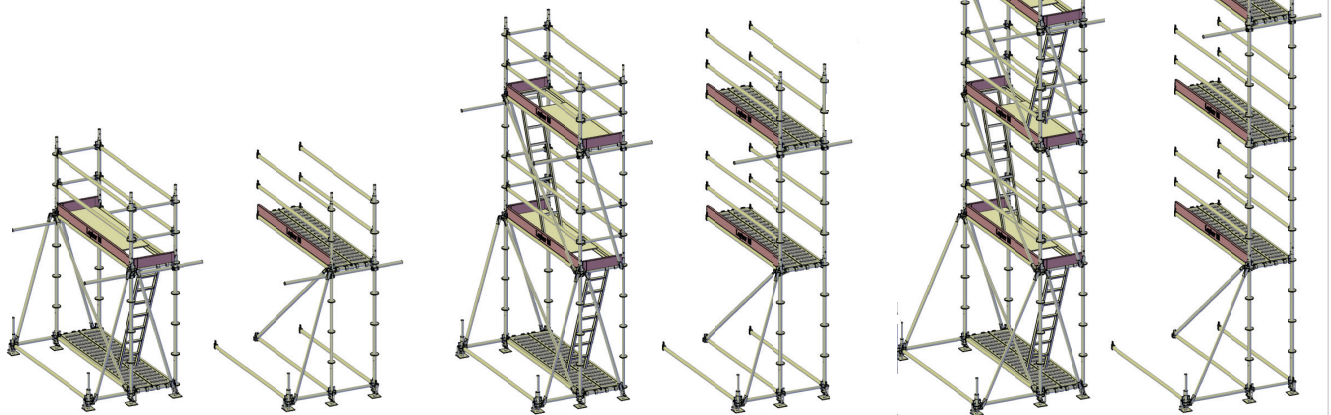

Basic module 73 x 257 cm  
1-ply  
W= 73, L=257, H~225 cm

Additional field 73x257 cm  
1-ply  
W= 73, L=257, H~225 cm

Basic module 73 x 257 cm  
2-ply  
W= 73, L=257, H~425 cm

Additional field 73x257 cm  
2-ply  
W= 73, L=257, H~425 cm

Basic module 73 x 257 cm  
3-ply  
W= 73, L=257, H~625 cm

Additional field 73x257 cm  
3-ply  
W= 73, L=257, H~625 cm



## Shoring TG 60

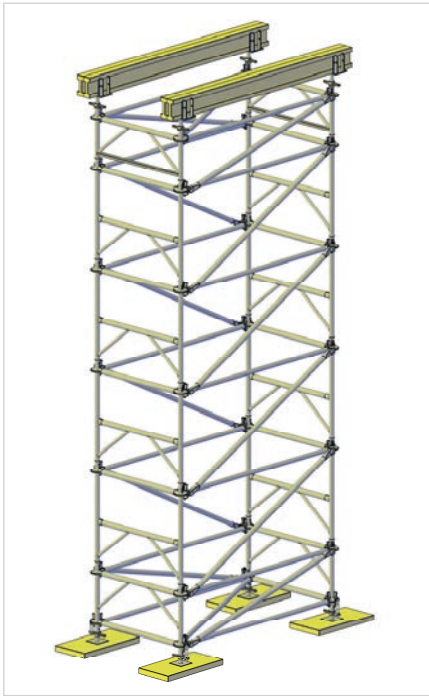

Shoring tower TG 60

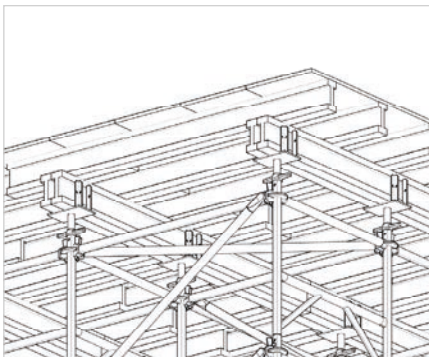

Support beam and cross-beam

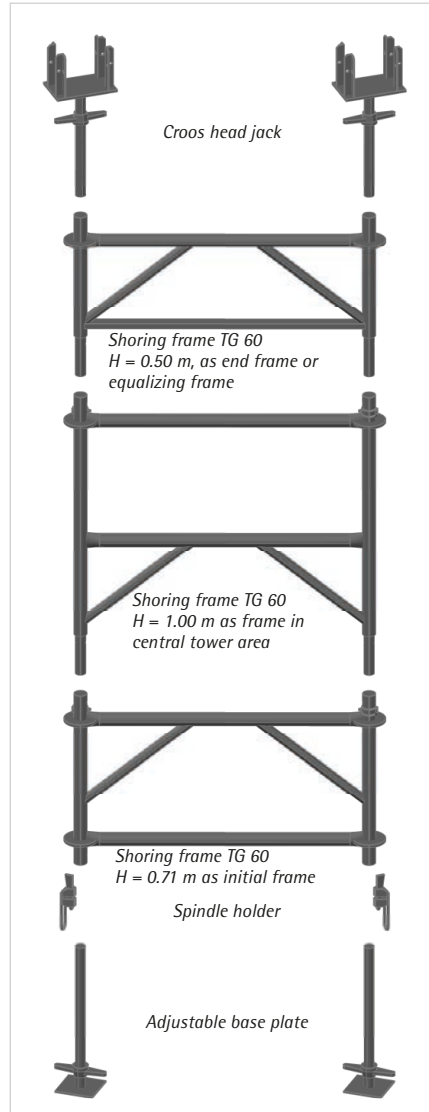

Basic components of the TG 60 shoring tower

The type-tested TG 60 shoring towers meet practically all the requirements placed on shoring towers at construction sites in the fields of civil engineering as well in the structural engineering and bridge-building sectors.

The TG 60 shoring towers were type-tested on the basis of DIN EN 12812:2008-12.

Rosettes integrated in the system permit the connection of modular Allround components. As a result, the TG 60 is an established part of the modular Allround construction kit. This combination with Allround components makes it possible to adapt the dimensions of the towers optimally in the light of the geometry and the structural requirements.

### Features of TG 60 shoring towers

- Integrated Allround rosettes.
- Lightweight individual parts, max. 18 kg, symmetrical frames.
- Assembly possible upright or on the ground.
- Frames can be combined in the case of load concentrations.
- Time-saving assembly without tubes and couplers.
- Only a hammer is required for assembly.
- No horizontal initial and end frames.
- Mobile with adaptable castors.
- Robust towers, wobble-free, no tilting pins.
- Suitable assembly decks.
- Safer assembly thanks to automatic and integrated advance guardrail.

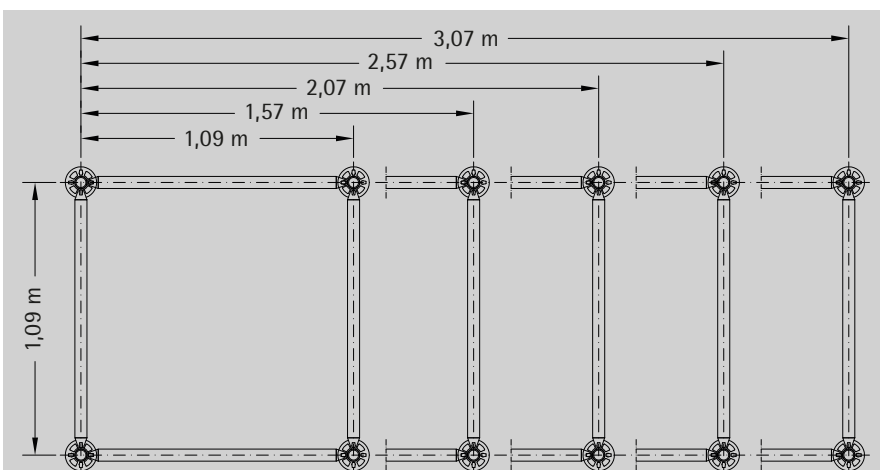

Shoring tower TG 60 - different base layouts

## Design of base and head

### Substructure of supports

One of the most important points when ensuring the stability of shoring and support scaffolding lies in the safer transmission of the loads into the ground surface. Up to a base support height of max. 40 cm, two or multi-layer squared-timber sections may be used without further verification provided that these are resistant to tilting and are arranged crosswise.

### Base plates and head jacks

The loads permitted at the base plates and head jacks depend on the height of the spindle extension and the horizontal loads. To achieve adequate spindle travel, spindles with a solid cross section are generally used for shoring structures. Swivelling head jacks ensure concentric load transmission with formwork inclined at an angle of up to 5 %.

In the case of crane movement, the base plates are prevented from falling out by spindle supports.



*Superstructure with spindle, support beam and cross-beam*



*Substructure of supports*



## Safe assembly and disassembly of the TG 60 shoring towers

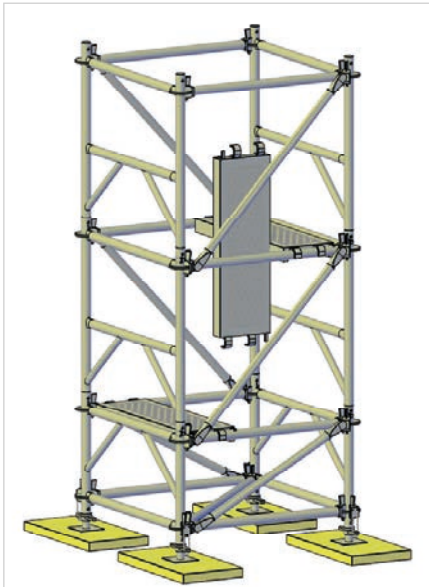

Repositioning the assembly decks

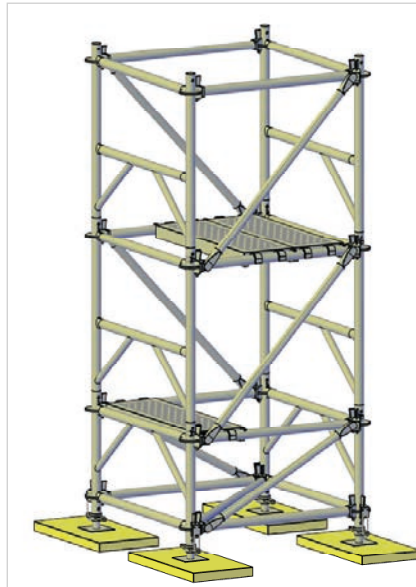

Ascent during assembly on the secured scaffolding level

The TG 60 shoring towers can be assembled either upright or on the ground. In all cases, the surface must be sufficiently stable and it may be necessary to use wooden boards to form a load-distributing base.

If assembled upright, the towers must be safeguarded against tilting and sliding during each successive assembly phase. They can be safeguarded against tilting in particular by the use of ballast, supports, anchoring or multiple securing sections. For more details on ballasting, please refer to the technical documents.

Besides the high level of stability, the safety of personnel when assembling and dismantling the shoring towers is of particular importance. Working in combination with the assembly decks, the erectors are protected against falls during every phase of the operation. Ascent and descent are only permitted on the inside of the towers.



Modularer Treppenturm

## Modular stair tower

The modular stair tower enables safe and comfortable access routes. It consists of modules, each 2.21 m high and with basic dimensions of 1.40 x 2.57 m (axle dimensions). The tower has a modular structure, i.e. each stair module can be mounted individually on the ground and lifted into place with the crane. This reduces assembly and dismantling work at greater heights to a minimum. The tower can be moved completely by crane by connecting the modules to each other with wire lock pins and the spindle holders from the TG60 range.

## Combining TG 60 frames

For very heavy loads, the shoring towers can be reinforced by the use of additional frames. The load capacity can be increased as required by combining frames. Depending on the structural requirements, additional frames can be connected to the end faces of the towers, e.g. using double wedge-head couplers.

Special attention must be paid to the question of load transmission when frames are combined. The overlying support construction must be designed in such a way that all the frame standards are subjected to approximately equal normal forces. The effect of this is similar to load centring. This can be achieved, for example, by using an extremely bending-resistant support beam mounted on relatively pliable cross-beams.



Combining TG 60 frames

## Mobile TG 60 shoring towers

If castors are mounted, then it is possible to create towers that can be moved on level and strong surfaces. The possibility of moving the towers from one position to another removes the need to repeat the time-consuming assembly and dismantling work.

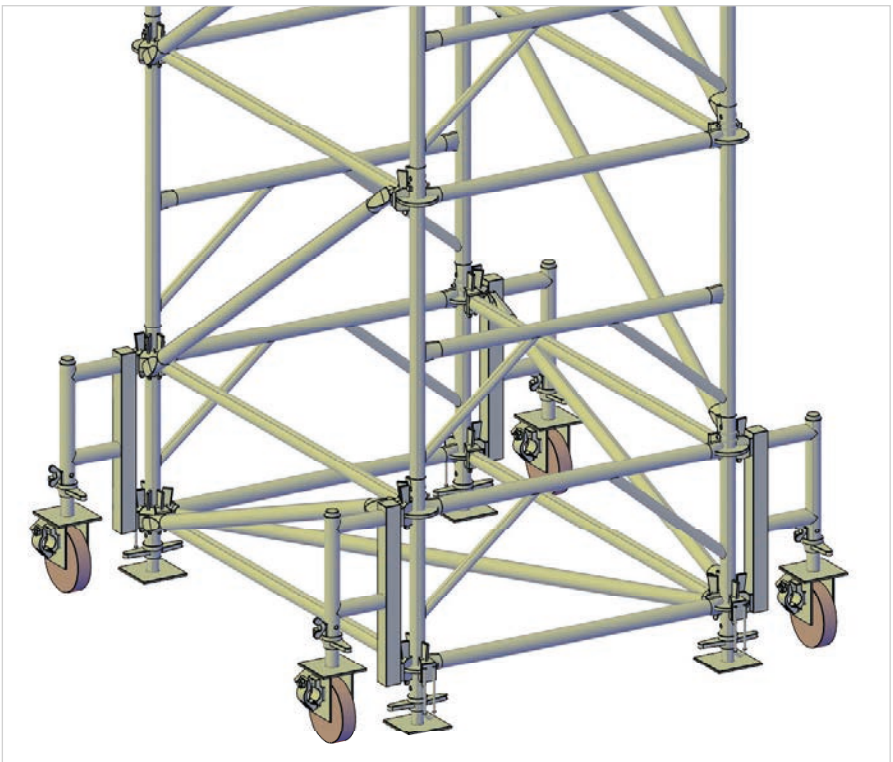

TG 60 tower with castors



## Class A

Class A covers simple structures in which the necessary stability can be obtained from knowledge, experience and proven procedures.

Class A can be assumed under the following conditions:

- Cross-sectional area of the top boarding max. 0.3 m<sup>2</sup> per metre of width.
- Cross-sectional area of a beam max. 0.5 m<sup>2</sup>.
- Free span of beams or top boarding max. 6.0 m.
- Clear height max. 3.5 m.

## Class B

In the case of class B shoring structures, a complete verification must be undertaken on the basis of the appropriate Eurocodes.

DIN EN 12812 defines additional boundary conditions and specifications for classes B1 and B2, and these must also be taken into account:

### Class B1

The assessment of the shoring structure must correspond to the relevant Eurocodes, i.e. every detail of the shoring structure must be assessed and documented. Detailed drawings that comply with the requirements placed on permanent structures must be available.

### Class B2

Although class B2 permits slightly simpler rating methods than class B1, it yields similar results since an additional safety factor of 1.15 must be incorporated on the resistance side. It is permissible to determine the support loads on the shoring structure in a simplified form from the load coverage areas.

## Assessment

The regulations applying to the assessment of shoring structures are set out in DIN EN 12812. Additional requirements relating to supporting towers made from prefabricated components can be found in DIN EN 12813.

Shoring structures must be dimensioned in such a way that all forces acting on them, both vertical and horizontal, can be transmitted into the surface of the ground or a strong and stable substructure.

Depending on the requirements and the assessment method used, DIN EN 12812 distinguishes between classes A and B, with class B being further subdivided into the subclasses B1 and B2. The engineer responsible for design must decide which class is to be used in each individual case.

The design and assessment work must be performed in a way that permits verification at the construction site.

## Logistics

Due to the high material requirements usually associated with the use of shoring, special pallets are available for storage, transport and provisioning of the construction site.

The TG 60 pallets are designed to accommodate 22 frames per layer. When full, they can hold a total of 44 standard frames (2 layers) or 88 equalizing frames (4 layers). The frames are arranged in three different intermeshed positions on the pallet. This maximizes the utilization of the storage space available on each pallet. The pallets can be used for all three types of TG 60 shoring frame and can be transported by crane and can be picked up from any side by a fork-lifter. They are optimized for transportation by truck – the width of 1.20 m means that two filled pallets can be placed side-by-side on the truck's loading surface. The units are stored upright on the pallets to prevent any water collecting in the tubes during bad weather.

When empty, a maximum of 18 pallets may be stacked on top of each other. Two full pallets can be stacked on top of another. For storage purposes, a sufficiently stable surface must be assured. The maximum permitted stack inclination of 2 % and the maximum permitted dynamic wind pressure of 0.2 kN/m<sup>2</sup> (corresponds to 64 km/h [40 mph] or wind strength 8) must be respected.

When transporting or storing shoring frames, the frames must be fixed on the pallet using tension straps or steel bands. To secure the items in position on tightening, it is necessary to use a securing profile.



Stacking of filled pallets



Filled pallet (with 22 standard frames)



Arrangement on the TG 60 pallets





## Risk assessment

### General risk assessment

During a general risk assessment, it is necessary to determine whether risks to personnel may arise due to the employed equipment and procedures or because of the working environment.

### Site-related risk assessment

A qualified person must ascertain whether the construction site exhibits hazards that are not covered by the general risk assessment.

### Assembly instructions

When shoring structures of class B1 and B2 are assembled, written assembly instructions must be provided by the company and contain all the necessary safety requirements. In the case of system scaffolding, these may also take the form of the scaffolding manufacturer's instructions for assembly and use.

Any divergences from the assembly instructions must be recorded in the conduct-of-works log together with the associated reasons.















Retention reservoir, D-Querfurt; Umwelttechnik und Wasserbau GmbH, D-Blankenburg



Gare Pont Rouge, L- Luxembourg; Consortium „TRALUX and Lux TP S.A.“, L- Luxembourg











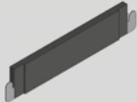

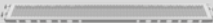
## Parts list

	Art.-N°	Item	kg
	N939.260.2036	Shoring frame TG60 0.50x1.09m 0.50m-spacer frame	13,00
	N939.260.2034	Shoring frame TG60 0.71x1.09m base frame	15,90
	N939.260.2035	Shoring frame TG60 1.00x1.09m 1.00m-standard frame	17,70
	N939.268.0109	Diagonal brace 1.09x0.50m	4,00
	N939.268.0157	Diagonal brace 1.57x0.50m	5,70
	N939.268.0207	Diagonal brace 2.07x0.50m	7,20
	N939.268.0257	Diagonal brace 2.57x0.50m	8,40
	N939.268.1109	Diagonal brace 1.09x1.00m	4,80
	N939.268.1157	Diagonal brace 1.57x1.00m	6,30
	N939.268.1207	Diagonal brace 2.07x1.00m	7,40
	N939.268.1257	Diagonal brace 2.57x1.00m	8,80
	N939.268.3073	Diagonal brace 0.73x2.00m	6,80
	N939.268.3109	Diagonal brace 1.09x2.00m	7,00
	N939.268.3140	Diagonal brace 1.40x2.00m	7,50
	N939.268.3157	Diagonal brace 1.57x2.00m	7,70
	N939.268.3207	Diagonal brace 2.07x2.00m	8,85
	N939.268.3257	Diagonal brace 2.57x2.00m	9,50
		N939.267.8109	h-d = horizontal diagonal brace O-Ledger 1.54 h-d 1.09x1.09m
N939.267.8158		O-Ledger 1.91 h-d 1.57x1.09m	6,70
N939.267.8209		O-Ledger 2.34 h-d 2.07x1.09m	8,40
	N939.531.4045	Head jack 45. solid. max. spindle travel 26cm GW 16cm	6,60
	N939.531.5045	Cross head jack 45. solid. max. spindle travel 26cm GW 8.5/17cm	6,90
	N939.560.2060	Base plate 60, solid, max. spindle travel 41cm	6,70







	Art.-N°	Item	kg
	N939.260.2000	Base collar	1,41
	N939.260.4050	Standard 0.50m without spigot	2,50
	N939.260.4100	Standard 1.00m without spigot	4,60
	N939.260.4116	Standard 1.17m with 3 rosette without spigot	6,10
	N939.261.7050	Standard 0.50m with pressed-in spigot	2,70
	N939.261.7100	Standard 1.00m with pressed-in spigot	4,90
	N939.261.7150	Standard 1.50m with pressed-in spigot	7,10
	N939.261.7200	Standard 2.00m with pressed-in spigot	9,30
	N939.261.7221	Initial standard 2.21m with pressed-in spigot	10,00
	N939.263.5257	O-Comfort stair 2.57x2.0x0.64m	29,20
	N939.175.2012	Internal stairway guardrail 1.50m T12 SW19	11,50
	N939.175.2007	Internal stairway guardrail 2.00m T12 SW19	13,50
	N939.175.2004	Stairway guardrail 1.0x0.5m SW19	6,20
	N939.263.8400	Stair guardrail post 1.3m for the stairwell at the top level	6,10
	N939.263.8401	O-Ledger 1.9m with wedge-head and U-fork for the stairwell at the top level	7,80
	N939.387.2257	O-Wood access deck L 2.57x0.61m incl. access ladder T9	26,50
	N939.387.4257	O-Alum. access deck L 2.57x0.61m incl. access ladder T9	26,50



## Parts list

	Art.-N°	Item	kg
	N939.264.2073	O-Toe board 0.73m	1,50
	N939.264.2109	O-Toe board 1.09m	2,50
	N939.264.2140	O-Toe board 1.40m	3,20
	N939.264.2257	O-Toe board 2.57m	5,70
	N939.260.1025	O-Ledger 0.25m	1,40
	N939.260.1045	O-Ledger 0.40m	2,10
	N939.260.1050	O-Ledger 0.50m	2,20
	N939.260.1073	O-Ledger 0.73m	2,90
	N939.260.1109	O-Ledger 1.09m	4,00
	N939.260.1140	O-Ledger 1.40m	5,00
	N939.260.1157	O-Ledger 1.57m	5,50
	N939.260.1207	O-Ledger 2.07m	7,00
	N939.260.1257	O-Ledger 2.57m	8,50
	N939.386.2140	O-Steel deck 1.40x0.32m T9	10,80
	N939.386.2109	O-Steel deck 1.09x0.32m T9	9,40
	N939.386.2157	O-Steel deck 1.57x0.32m T9	12,50
	N939.386.2207	O-Steel deck 2.07x0.32m T9	16,00
	N939.386.2257	O-Steel deck 2.57x0.32m T9	18,90
	N939.263.1109	O-Console bracket 1.09m	12,00
	N939.175.4175	Wall tie 1.75m	5,80
	N939.260.2019	Rosette clampable SW19mm	1,14
	N939.260.2032	Shoring spigot for base frame 0.71x1.09m	1,10
	N939.260.2033	Base support	0,80
	N939.260.2040	Castor adaptor	6,40
	N939.521.7200	Castor 1200 with half coupler permitted load: 12kN	12,00
	N939.262.9019	Wedge head swivel coupler SW19	1,50
	N939.473.8019	Reducing swivel coupler d.48 x33.7 SW19	1,60

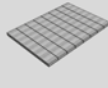
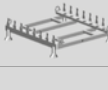
Subject to technical changes

	Art.-N°	Item	kg
	N939.490.5667	20pcs. Hinged pin D12	2,00
	N652.021.1000	Tube d.48.3x3.25x1000 EN39 galvanized	3,60
	N652.021.2000	Tube d.48.3x3.25x2000 EN39 galvanized	7,40
	N652.021.2500	Tube d.48.3x3.25x2500 EN39 galvanized	9,00
	N652.021.3000	Tube d.48.3x3.25x3000 EN39 galvanized	10,80
	N652.021.4000	Tube d.48.3x3.25x4000 EN39 galvanized	14,40
	N652.021.5000	Tube d.48.3x3.25x5000 EN39 galvanized	18,00
	N652.021.6000	Tube d.48.3x3.25x6000 EN39 galvanized	21,60
	N939.510.5085	Tube pallet 85	30,80
	N939.510.5125	Tube pallet 125	35,00
	N939.511.3000	Modular lattice box without bottom	61,80
	N939.649.4514	Timber base plate for lattice box	24,00
	N939.511.3003	Shoring frame pallet TG60	53,70
	N939.511.3004	Loading and stacking securing U-profile for frame pallet TG60 with spigots	3,90
	N939.511.3005	Loading and stacking securing L-profile for frame pallet TG60 without spigots	3,40

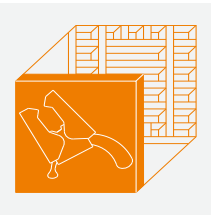

# Compatibility





## **All PASCHAL formwork systems are compatible with each other.**

Flexibility is a strength of PASCHAL.

All formwork systems are fully compatible. No more time-consuming and expensive on-site formwork additions!.

## Compatibility

Frequently different formwork systems have to be combined on a building site. This occurs quite obviously at the transition from a straight wall into a circular wall when the whole wall has to be formed in one phase. The PASCHAL systems are ideal for such special requirements, because all the various PASCHAL formwork systems are compatible with each other. This means that all systems can be joined directly or using connecting panels. This is uncomplicated because existing connecting pieces such as clamps or bolts are suitable for both direct connections and connecting panels.



Elevated tanks, D-Galgenberg; Wolf & Sofsky SF Tief- und Ingenieurbau GmbH, D-Zweibrücken



Connection Modular/NeoR



Connection TTR/NeoR

27

## Combi clamp

The quickest connection is assured by the combi clamp, which connects the LOGO formwork elements directly with the Modular elements or the segments of the Trapezoidal Girder Formwork.



Connection LOGO/TTR



Connection NeoR/LOGO



## Circular wall – straight wall



Parzival school, D- Karlsruhe; Weisenburger Bau GmbH

You can use all PASCHAL formwork systems to connect a straight wall to a circular wall. For example, GE panels, LOGO panels and Athlete panels fit onto the segments of the Trapezoidal Girder Formwork.

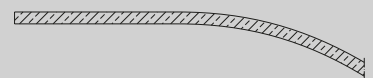
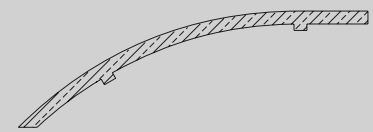
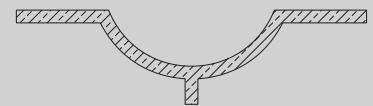

The combination of LOGO.3 panels and half circles of the Circular Column formwork produce a circular wall end.

The half circles can always be combined with all PASCHAL wall formwork systems.

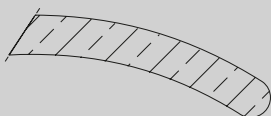

## Circular wall end

The advantages of the PASCHAL systems are quite obvious:

27

- All formwork systems can be combined without any problems, i.e. they are compatible. Even complicated combinations with artistic cross sections are possible.
- No time-consuming and expensive extra forming on site!
- No additional accessories required!



## Practical examples



Residential complex; JERO Ingenieurbau GmbH, D-Berlin





Gymnasium, F-Flaxlanden; Mader Entreprise Générale de Bâtiment Z.I., F-Guebwiller



Sewage plant, L-Grevenmacher ; Fa. OBG LUX S.A., L-Ellange

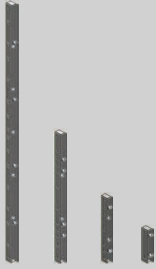

## Parts list

	Art.-N°	Item	kg
	N287.500.0026	Combi clamp LOGO-N/ TR/R	2,20
		<b>Connecting panel Circular column- Modular</b>	
	N180.002.0067	10x 75 cm without overlap	8,70
	N180.002.0068	10x 75 cm with overlap	8,80
	N180.002.0069	10x 125 cm without overlap	14,40
	N180.002.0070	10x 125 cm with overlap	14,50
	N180.002.0071	10x 150 cm without overlap	17,10
	N180.002.0072	10x 150 cm with overlap	17,20
	N180.002.0093	10x 275 cm without overlap	31,00
N180.002.0094	10x 275 cm with overlap	31,00	
		<b>TTK connecting panel to TTR cpl.</b>	
	N182.008.0010	6x 300 cm	31,80
	N182.008.0011	6x 150 cm	16,30
	N182.008.0012	6x 75 cm	8,50
N182.008.0013	6x 37,5 cm	4,50	

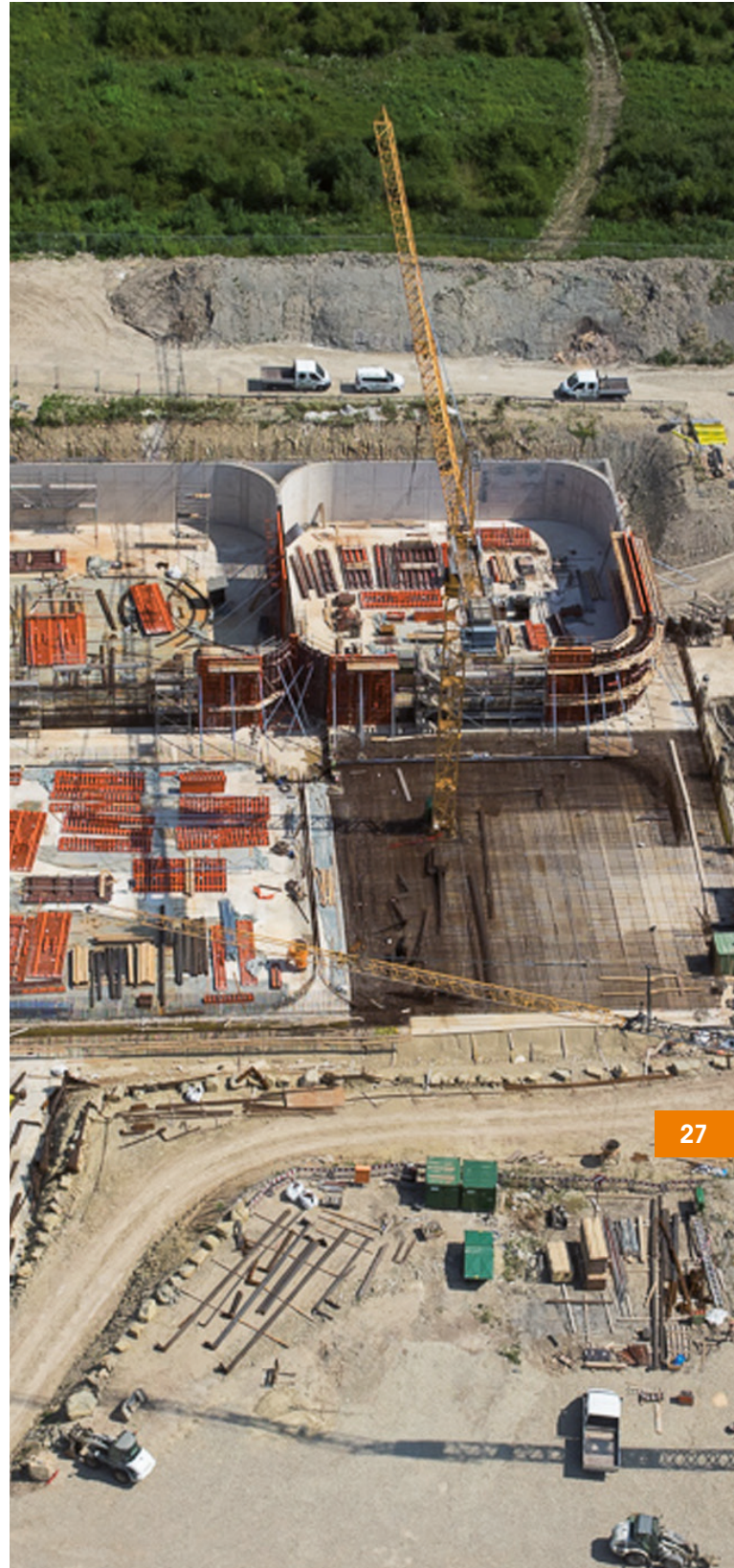

Sewage plant, L-Grevenmacher ; OBG LUX S.A., L-Ellange

Subject to technical changes



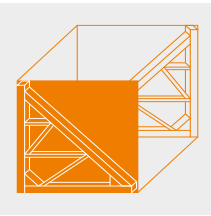

# Single-sided

Single-sided forming





## Single-sided forming

Regardless whether single-sided forming is to be used against existing buildings, rows of bored piles or sheet piling, the concrete pressures and lifting forces have to be discharged reliably into the ground (ground plate, foundation). This is why the anchoring of the formwork is particularly important. PASCHAL provides absolutely safe and economical tried and tested solutions for these tasks:

Supporting jacks in various sizes are simply ideal for these demands. They are designed in such a way that they reliably discharge all forces and can be assembled quickly to fixed points on the formwork panels.

## Single-sided forming Supporting jack

PASCHAL supplies supporting jacks for walls up to 6,00 m high. For greater pouring heights, additional supports are used in addition to the supporting jack.

Never take the risk of improvised supports, because it is easy to underestimate the concrete pressures and lifting forces!

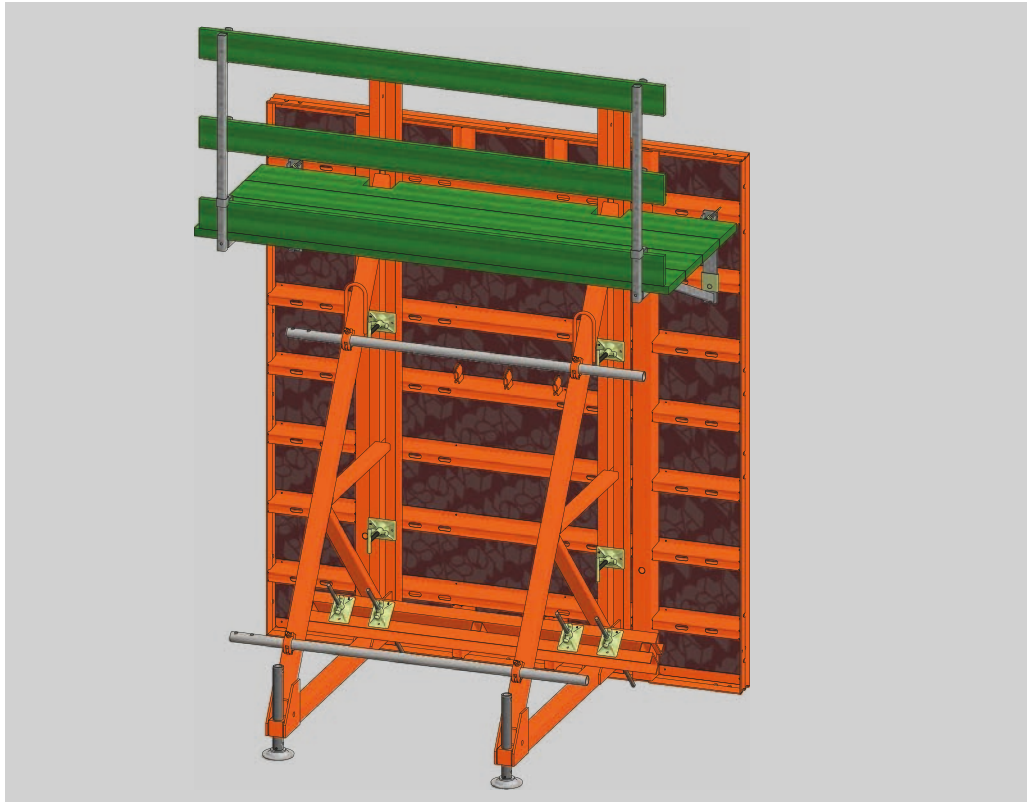

Supporting jack	1,50 m	3,00 m	4,00 m	6,00 m	8,00 m
Height	1,50 m	3,00 m	4,00 m	6,00 m	8,00 m
Depth	0,90 m	1,62 m	2,30 m	3,25 m	4,41 m
Pour height	up to 2,00 m	up to 3,50 m	up to 4,75 m	up to 6,00 m	up to 8,00 m

## Examples

PASCHAL supporting jacks are designed to be used with all formwork systems. Connections are available for rapid, uncomplicated assembly.

For large formwork heights, the supporting jack 4,00 m is supplemented by a base extension 2,00 m high (picture on the right) to build a supporting jack altogether 6,00 m high (picture middle).

With PASCHAL supporting jacks, you can:

- Reliably discharge all occurring forces
- Use all formwork systems
- Form all heights up to 6,00 m without additional supports
- Even form 90° corners economically with the corner waler



Fish ladder, F- Rohrschollen; GTM-HALLE, F-Schiltigheim

Supporting jack 6,00 m with LOGO.3 formwork.





Extension of tram line D, F-Strasbourg; EIFFAGE CONSTRUCTION, F-Strasbourg

## Pre-assembling

It is possible to economize on assembly times and crane workload if several pre-assembled formwork panels can be moved at once, for example forming step-by-step.

But how can we make this even more economical? This is easy: simply by pre-assembling the supporting jacks to the formwork panels. This large-size combination can be repeatedly moved without having to be dismantled. Every supporting jack has a crane lifting eye for transport.

Supporting jack 3,00m with LOGO.3 formwork

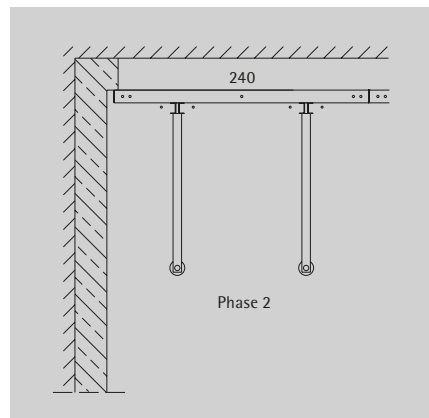
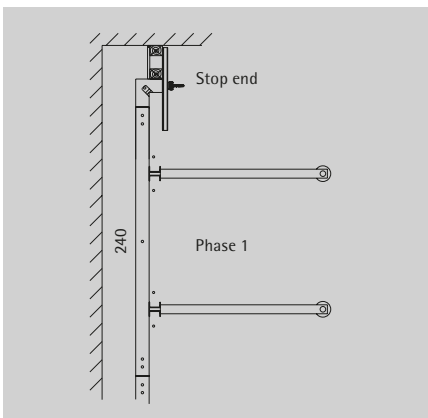

## Corner applications

### Version 1

There are two different possibilities to form a 90° corner single-sided. The simple solution is to form the two walls individually or one after the other (picture on the right).



Corner waler with supporting jack 3,00 m for 90° corners.

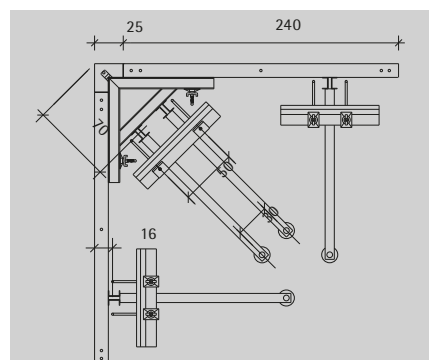

Main-line drawing for using the corner waler.

### Version 2

Forming a 90° corner in one single step is more difficult. Conventional supports do not have enough space, as they would overlap in the corner. The PASCHAL corner waler is used to couple the two supporting jacks needed in the corner and positioned at a 45° angle to the formwork (picture below). The corner waler can be used for all PASCHAL systems.



## Special uses for supporting jacks

*Why not a creative solution?*

*Here the 6,00m supporting jack was used lying down, not positioned standing on the ground but hanging from a vertical wall. It supports the formwork for the cantilever plate of a water tower. This solution is much more economical than a complete shoring system, with considerable savings in material and assembly times.*



Water tower, Lauterbach; Walter Bau AG, Kirkel-Limbach

28

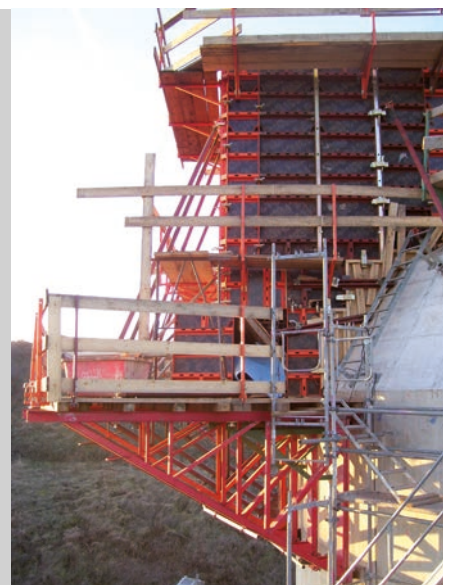
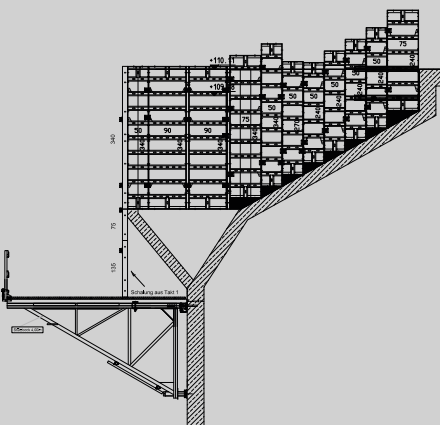

Sewage plant - Extension of the digestion tower, D-Rollsdorf; beton & rohrbau GmbH & Co.KG, D-Halle



Kombi V-guide DW15/DW20

V-guide DW26,5

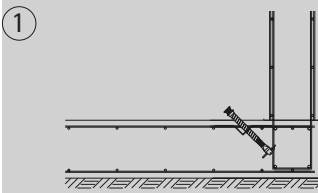

Fitting the kombi V-guide, concreting

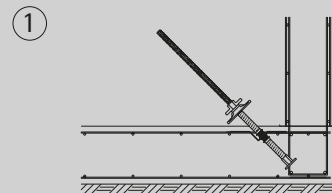

Fitting the V-guide DW26,5 with tie rod, concreting

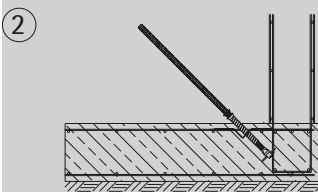

Screwing in the tie rod

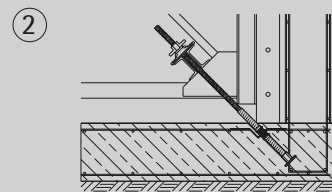

Assembling the formwork, supporting jack and waler

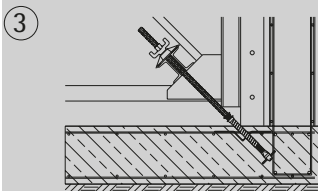

Assembling the formwork, supporting jack and waler



## Fitting anchors

An important phase when forming single-sided walls is fitting the necessary anchors. They must already be inserted in the reinforcement when this is applied so they remain immovable in the foundation which is being concreted. The supporting jacks are then fastened to the anchors later.

The spacing between the anchors is defined by the formwork panels. Foresighted planning can save on subsequent additional costs.

The pictures shown here explain the procedure for fitting the kombi V-guide DW15 (middle column) and the V-guide DW26,5 (right column). The anchors and tie rods are rated according to the resulting tensile forces. Two anchors are always provided for every supporting jack for statical reasons.







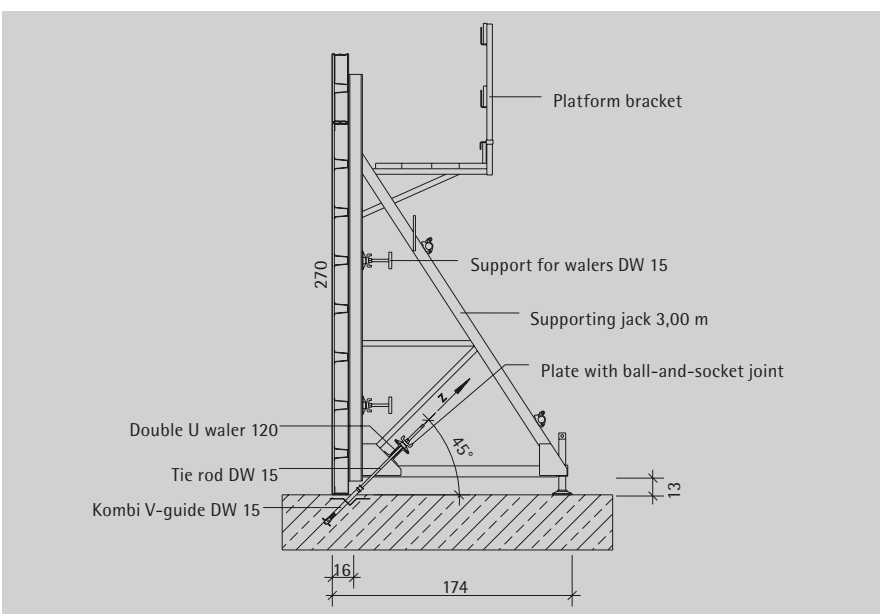

















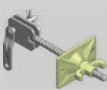
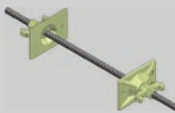

## Anchor clearance

The cross section of the complete structure for a piece of single-sided formwork shows all components used: a LOGO panel; the supporting jack 3,00 m; the complete anchoring; the connections of formwork to supporting jack; the platform bracket. All system dimensions are stated.

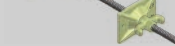
For further details, please refer to the "Technical Information" for the corresponding formwork systems.



## Parts list

	Art.-N°	Item	kg		Art.-N°	Item	kg
	N189.005.0048	Supporting jack 1,50 m	47,50		N181.000.0008	GE connecting piece cpl. for supporting jack (2 sets)	1,09
	N189.005.0056	Supporting jack 3,00 m	145,00		N181.000.0047	GE connecting piece cpl. for supporting jack 3,00 m	3,45
	N189.005.0054	Supporting jack 4,00 m bottom extension possible	320,00		N181.000.0018	GE connecting piece cpl. for supporting jack 4,00 m consisting of: 2 fittings 1 securing	5,60
	N189.005.0055	Base extension 2,00 m cpl. for supporting jack 4,00 m (to 6,0m)	240,08		N181.000.0022	GE connecting piece cpl. for supporting jack 6,00 m consisting of: 3 fittings 1 securing	7,70
	N189.005.0053	Supporting jack 6,00 m 2 pieces cpl.:	554,41		N187.500.0021	Connecting piece cpl. for supporting jack L/N/A	
		Supporting jack 4,00 m bottom extension possible			N187.500.0021	1,50 m (1 set)	1,95
		Base extension 2,00 m cpl. for supporting jack 4,00 m			N187.500.0035	3,00 m (2 sets)	3,90
	N289.005.0082	Base extension 2,00 m cpl. for supporting jack 6,00 m (to 8,0m)	510,00		N187.500.0036	4,00 m (3 sets)	5,85
	N189.005.0057	Waler for corners for supporting jack 3,00/4,00 m cpl.	56,84		N187.500.0037	6,00 m (4 sets)	7,80
		Modular connecting piece cpl. for supporting jack			N182.000.0091	Girder connecting piece cpl. for supporting jack	
	N180.000.0007	1,50 m (1 set)	2,34		N182.000.0091	3,00 m (2 sets)	6,96
	N180.000.0028	3,00 m (2 sets)	4,68		N182.000.0097	4,00 m (3 sets)	10,44
	N180.000.0032	4,00 m (3 sets)	7,02		N182.000.0098	6,00 m (4 sets)	13,92
	N180.000.0033	6,00 m (4 sets)	9,36		N189.001.0120	Double channel waler 120 for supporting jack 1,50/3,00/4,00 m	
					N189.001.0120	180 cm	50,50
					N189.001.0121	90 cm	25,00
					N189.001.0125	Double channel waler 160 for supporting jack 6,00 m	
					N189.001.0125	180 cm	70,00
					N189.001.0126	90 cm	35,50



## Parts list

	Art.-N°	Item	kg
	N940.014.0150	Combi V-guide DW15	0,59
	N940.014.0151	Combi V-guide DW20	1,04
	N189.001.0008	Hexagon nut DW 26,5 x 60 SW46	0,54
	N189.001.0062	Counter plate 12 x 12 x 2,0cm, ø 32 mm	2,20
	N189.007.1500	Tie rod DW 26,5 x 150cm working load 280KN	6,60
	N189.007.2000	Tie rod DW 26,5 x 200cm working load 280KN	8,80
	N189.012.2000	PVC-tube ø 32x200cm	0,64
	N189.014.0013	PVC-cover ø 32 mm	0,02
	N189.001.0025	Anchor plate DW26,5 for supporting jack	2,50
	N940.014.0162	Guide V DW26,5	0,42
	N941.015.0033	Open ended spanner SW46 DIN 894, phos- phated	0,75



Complete renovation of the downstream reser-voir on the Sösetalsperre dam;  
Umwelttechnik & Wasserbau GmbH, D-Blankenburg/Harz



Retaining wall, renovation of the Thale through road; Umwelttechnik & Wasserbau  
GmbH, D-Blankenburg/Harz

Subject to technical changes

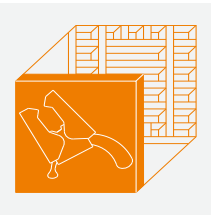

# Consumption

Supports and consumption material

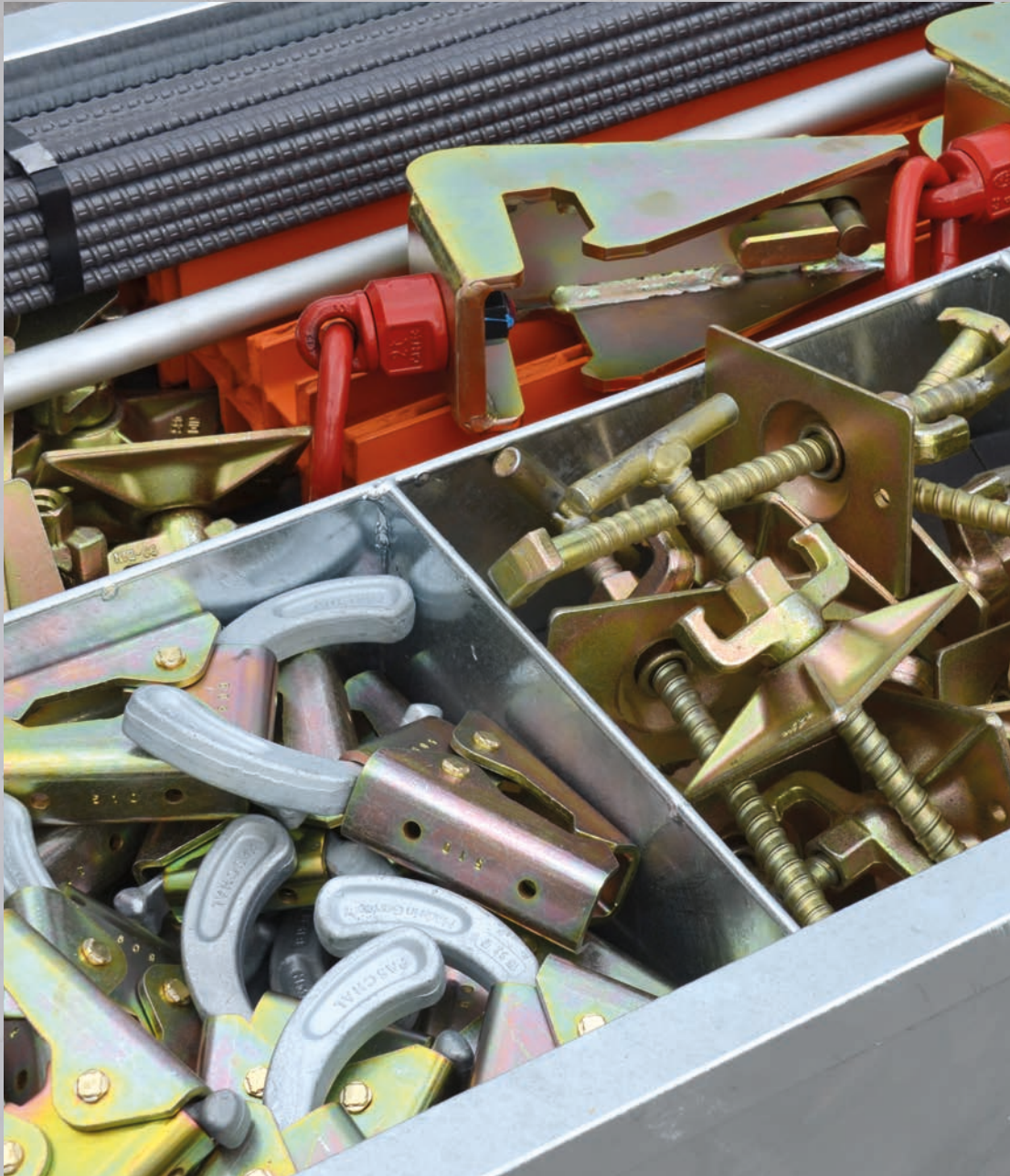





## Original accessories and consumables

The right formwork accessories & consumables for your PASCHAL quality formwork.

Whether you are looking for a base plate, a suspending piece for props, security bolts or consumables such as spacers, UNI concrete anchors, UNI concrete sleeves, formwork stops or chamfer angles of various sizes - you can buy all the accessories you need for your formwork operations from PASCHAL.













## Parts list

	Art.-N°	Item	kg		Art.-N°	Item	kg
	N189.005.0001	<b>Prop/Support</b> Support variable 105-150 cm	9,50		N180.000.0025	Suspending piece for props cpl. N/R	2,65
	N189.005.0006	Adjustable prop RS2 180-290 cm	11,00		N189.005.0028	Suspending piece for props cpl. with spring lock	3,00
	N189.005.0007	<b>Adjustable prop</b> RSK4 260-400 cm	20,00		N187.500.0003	Suspending piece for props cpl. L/N/A	2,00
	N189.005.0008	RSK6 460-600 cm	36,00				
	N189.005.0009	RSK8 620-760 cm	84,00				
	N189.005.0014	<b>Adjustable prop</b> 175-285 cm	18,20		N181.000.0004	Suspending piece GE for props and walers cpl.	4,30
	N189.005.0015	255-405 cm	33,50		N182.000.0096	Suspending piece for props Trapezoidal girder	3,00
	N189.005.0016	400-620 cm	54,50				
	N189.005.0017	620-1000 cm	110,00				
	N189.005.0010	<b>Adjustable prop BKS</b> BKS4 710-850 cm	165,20		N185.000.0039	Fixation of adjust. prop f. paperboard column ø 15 - 75 cm	2,00
N189.005.0060	BKS5 840-980 cm	187,20					
N189.005.0013	BKS6 970-1100 cm	209,00					
N189.005.0034	BKS7 1080-1220 cm	237,00					
N189.005.0058	BKS8 1210-1350 cm	259,20					
N189.005.0083	BKS9 1320-1460 cm	287,20					
N189.002.0004	<b>Stacking pallet</b> 165 x 110 cm hot-dip galvanized	59,00	N185.000.0037	Fastening part f. paperboard column ø 15 - 75 cm	1,40		
N189.002.0005	<b>Stacking pallet</b> 240 x 80 cm hot-dip galvanized	72,50					
N189.005.0023	<b>Foot plate 3 holes cpl.</b>	4,20	N185.000.0038	Suspending piece f. paperboard column ø 15 - 75 cm	0,60		
N189.005.0033	<b>End plate articulation for adjustable prop BKS</b>	7,20	N189.001.0069	Security bolt 130 cpl.	0,32		
N189.005.0045	<b>Articulation for prop (without security bolt 130)</b>	1,50	N189.001.0070	Security bolt 100 cpl.	0,29		
				N189.005.0041	Ground nail ø 20x 55 cm forged	1,70	
				N189.015.0000	<b>PVC chamfer angle</b> 2,3 x 250 cm	0,35	
			N189.015.0002				1,2 x 250 cm
				N949.000.0013	Sealing tape 12x3 mm 10m roll (10 pieces per box)	0,03	

Subject to technical changes



















## Parts list

	Art.-N°	Item	kg		Art.-N°	Item	kg				
		PVC tube ø 22 mm with covers length:			N189.012.2000	PVC-tube ø 32 mm standard length 200 cm	0,64				
	N189.011.0150	15,0 cm	4,40			N189.014.0013	PVC-cover ø 32 mm	1,70			
	N189.011.0175	17,5 cm	4,70				N189.014.0010	PVC-plug ø 32 mm	0,90		
	N189.011.0200	20,0 cm	5,20					Fibre-concrete tube for DW15 ø 22 mm			
	N189.011.0240	24,0 cm	5,90					wall thickness	tube length		
	N189.011.0250	25,0 cm	6,00					N189.016.0100	12,0	10,0	0,18
	N189.011.0300	30,0 cm	6,80					N189.016.0130	15,0	13,0	0,23
	N189.011.0350	35,0 cm	7,70					N189.016.0180	20,0	18,0	0,32
	N189.011.0365	36,5 cm	7,90					N189.016.0200	22,0	20,0	0,35
	N189.011.0400	40,0 cm	8,50					N189.016.0220	24,0	22,0	0,39
	N189.011.0450	45,0 cm	9,30					N189.016.0230	25,0	23,0	0,41
N189.011.0500	50,0 cm	10,20	N189.016.0280	30,0				28,0	0,50		
N189.010.3000	Standard length 300 cm without covers	0,50	N189.016.0330	35,0	33,0			0,58			
	N189.014.0001	PVC-covers ø 22 mm	1,10	N189.016.0345	36,5	34,5		0,61			
		N189.014.0009	PVC plug ø 22 mm	0,40	N189.016.0360	38,0	36,0	0,63			
		N189.018.0044	PVC interior plug ø 22 mm	1,00	N189.016.0380	40,0	38,0	0,67			
		PVC-tube ø 26 mm with covers length:			N189.016.1250	Standard length 125 cm	2,20				
	N189.042.0150	15,0 cm	5,00			Fibre-concrete tube for DW20 ø 27 mm					
	N189.042.0175	17,5 cm	5,50			wall thickness	tube length				
	N189.042.0200	20,0 cm	6,00			N189.043.0118	12,0	11,8	0,20		
	N189.042.0240	24,0 cm	7,10			N189.043.0138	14,0	13,8	0,23		
	N189.042.0250	25,0 cm	7,20			N189.043.0148	15,0	14,8	0,25		
	N189.042.0300	30,0 cm	8,80			N189.043.0158	16,0	15,8	0,27		
	N189.042.0350	35,0 cm	10,00			N189.043.0178	18,0	17,8	0,30		
	N189.042.0365	36,5 cm	10,40			N189.043.0198	20,0	19,8	0,34		
	N189.042.0400	40,0 cm	11,20			N189.043.0218	22,0	21,8	0,37		
	N189.042.0500	50,0 cm	13,60			N189.043.0228	23,0	22,8	0,39		
N189.041.2000	Standard length 200 cm without covers	0,41	N189.043.0238	24,0		23,8	0,40				
	N189.014.0015	PVC-cover ø 26 mm	1,30	N189.043.0248	25,0	24,8	0,42				
		N189.014.0016	PVC-plug ø 26 mm	0,60	N189.043.0278	28,0	27,8	0,47			
				N189.043.0298	30,0	29,8	0,51				
				N189.043.0328	33,0	32,8	0,56				
				N189.043.0338	34,0	33,8	0,57				
				N189.043.0348	35,0	34,8	0,59				

Subject to technical changes

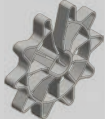

















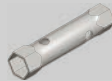





## Parts list

	Art.-N°	Item	kg		Art.-N°	Item	kg
	N189.043.0358	36,0 35,8	0,61				
	N189.043.0363	36,5 36,3	0,62				
	N189.043.0378	38,0 37,8	0,64				
	N189.043.0398	40,0 39,8	0,68				
	N189.043.1250	Standard length 125 cm	2,12				
	N189.014.0019	Cover ø 27 mm for fibre-concrete tube	% 3,92				
	N189.017.1250	Fibre-concrete tube ø 32 mm standard length 125cm	2,80				
	N189.014.0005	PVC-stick-on cone ø 32 mm for fibre-concrete tube	% 0,70				
	N189.018.0002	Mortar 3/25 for fibre-concrete tube	25,00				
	N189.018.0014	Injection pistol for mortar 3/25	1,00				
	N189.018.0003	Extension jet for injection pistol	0,03				
	N189.018.0001	Repoxal 2-component glue for fibre-concrete tube with hard.	1,00				
		Fibre-concrete plug length 2 cm					
	N189.018.0047	ø 22 cm	% 1,70				
	N189.018.0041	ø 27 cm	% 2,30				
	N189.018.0049	ø 32 cm	% 3,40				
	N680.000.0178	PVC-plug ø 23,5 + 24 mm for filler post L/N/R	% 0,25				
	N680.000.0083	PVC-plug ø 29,5 mm for Athlet panels	% 0,50				
	N680.000.0150	PVC-plug ø 21 mm sinkable PE-LD for panels L/N	% 0,20				
	N189.014.0023	PVC-plug gpn 300 v232 ø 25 mm for Girder Formwork	% 0,50				
	N189.014.0021	PVC-sealing plug ø 34 mm for Modular formwork	% 0,20				
		Spacer strip length 250cm concrete cover					
	N940.025.0002	20 mm (bundle = 40 pc)	0,12				
	N940.025.0003	25 mm (bundle = 40 pc)	0,16				
	N940.025.0001	30 mm (bundle = 40 pc)	0,20				
	N940.025.0004	35 mm (bundle = 20 pc)	0,24				
	N940.025.0005	40 mm (bundle = 20 pc)	0,28				
	N940.025.0006	50 mm (bundle = 20 pc)	0,29				
		Ring Ah					
	N940.000.0572	10/25 mm	% 0,60				
	N940.000.0570	10/30 mm	% 0,80				
	N940.000.0573	10/35 mm	% 1,20				
	N940.000.0575	10/40 mm	% 1,60				
	N940.000.0574	10/50 mm	% 1,90				
		Reinforcement spacer					
	N940.021.0001	distance 12-4/150/30	% 3,00				
	N940.021.0027	distance 12-4/175/30	% 3,00				
	N940.021.0002	distance 12-4/200/30	% 2,60				
	N940.021.0003	distance 12-4/240/30	% 2,80				
	N940.021.0004	distance 12-4/300/30	% 3,50				
	N940.021.0005	distance 12-4/360/30	% 4,00				
	N940.025.0020	Stop end 48 mm	0,03				

Subject to technical changes



## Parts list

	Art.-N°	Item	kg		Art.-N°	Item	kg
	N940.014.0005	Concrete anchor DW15 22.96-15	0,28		N187.500.0023	Uni carbide scraper LOGO 100x850 mm	1,20
	N940.014.0163	V2A Uni concrete anchor DW 15 cpl. w. cone peg and cap	0,17		N930.007.0023	Brush fillet for uni carbide scraper LOGO	0,17
	N940.014.0168	Uni concrete bush DW 15 cpl. w. cone peg and cap	0,07		N670.200.0050	Scraper blade for uni carbide scraper LOGO left	0,02
		PASCHAL-parting compound P 300			N670.200.0051	Scraper blade for uni carbide scraper LOGO middle	0,02
	N189.003.0011	200 ltrs. barrel	187,00		N670.200.0052	Scraper blade for uni carbide scraper LOGO right	0,02
	N189.003.0013	30 ltrs. can	25,00		N900.933.0001	Hexagonal screw M5x20 DIN933 8.8/galvanized	% 0,40
		PASCHAL-parting compound P 2000			N900.985.0005	Hexagon locknut M5 DIN985 galvanized	% 0,10
	N189.003.0018	200 ltrs. barrel	187,00		N941.015.0165	Hexagon socket wrench SW 36/41	3,70
	N189.003.0019	30 ltrs. can	25,00		N941.018.0051	Hammer no. 298/600 Picard	0,76
	N189.003.0009	Parting compound pistol 5 litres	4,30		N941.015.0033	Open ended spanner SW 46 DIN 894, phosphated	0,75
	N189.003.0008	Parting compound pistol 10 litres	5,75		N940.014.0165	Tie rod key DW15	1,00
		Uni carbide scraper 50 x 850 mm with 3 carbide turn plates	1,00		N940.014.0171	Tie rod key DW20	1,42
	N940.018.0003	Uni carbide scraper 50 x 850 mm with 3 carbide turn plates	1,00		N940.100.0000	Perforated foundation tie 50x2, roll at 25m perforation 20/22 each 5cm	15,70
	N940.018.0004	Uni carbide scraper 50 x 1300 mm with 3 carbide turn plates	1,10		N940.014.0007	Hexagon nut DW15x90 SW30 with middle pin	0,40
	N940.018.0001	Uni carbide scraper 100 x 850 mm with 6 carbide turn plates	1,20		N940.100.0156	Magnetic tape 50mm x 0,9mm x 30,5m for dismantling inside corner	5,60
	N940.018.0002	Uni carbide scraper 100 x 1300 mm with 6 carbide turn plates	1,30				
	N940.018.0005	Uni carbide scraper 175 x 850 mm with 10 carbide turn plates	1,40				
	N940.018.0006	Uni carbide scraper 175 x 1300 mm with 10 carbide turn plates	1,50				
	N940.018.0010	Replacement carbide turn plates 16,5x16,5mm with screws	0,02				
	N940.018.0011	Replacement blade inclined 50 mm	0,04				
	N940.018.0012	Replacement blade inclined 100 mm	0,07				
	N940.018.0013	Replacement blade inclined 175 mm	0,12				

Subject to technical changes

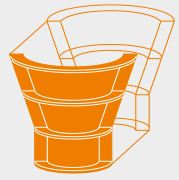

# Custom formwork





## Custom formwork

PASCHAL carries out custom formwork made of timber, steel, or combinations of materials in close collaboration with its customers for specialised areas of application.

Special formwork from PASCHAL is also used in concrete precast elements, where time and cost savings, shorter construction times and a high level of quality and precision are vital.

PASCHAL's building-specific formwork and its formwork for precast elements are designed according to customer requirements, refined with the client, and finally produced to very high quality standards in PASCHAL's own manufacturing department.

## Wood and steel Custom formwork

Modern formwork systems are capable of providing building contractors with rational formwork solutions consisting of system components for most concrete structures.

With its Universal Formwork System Modular/GE and Trapezoidal Girder System, with adjustable radii, PASCHAL has pushed the feasibility limits for system formwork out even further. But even so, there are still certain shapes and surfaces which cannot be produced with any system formwork. For example, whereas smaller fittings and inlays for system formworks or supplementary formwork can be used usually without any problems. To create or add special concrete surfaces on the job site, this is rarely the case and usually not the most economical solution where larger custom formwork is concerned.



*Vault formwork, F-Rougement; GTM, F-Les Magny*

### Wood and steel Custom formwork

Larger custom formwork of wood or steel needs meticulous preparation. Usually it is planned with modern CAD systems and created with corresponding workload in carpentry businesses or metal fitters, and erected for test purposes as required. This is usually not possible on the job sites where sufficient space, time, experts and necessary equipment are simply not available. Therefore fewer and fewer building contractors attempt to create such custom formwork themselves, but outsource such services to their formwork supplier who has the necessary prerequisites and vast experience with custom formwork.

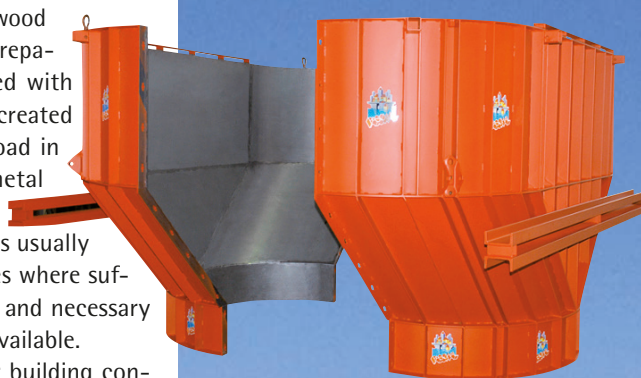

*Bridge pier Danube bridge Traismauer, Link Nord RFB; Co. Alpine Bau GmbH, A-Vienna*

PASCHAL's custom formwork department offers a professional all-in service for custom formwork.





*Formwork for liner segments – Linthal (Switzerland)*

As a rule, the crucial factors in deciding whether special formwork will be constructed in wood or steel are the frequency of use and the surface structure required of the concrete.

If a long service life, combined with frequent usage, is important, then the expensive solution of a steel construction is more cost-effective than a correspondingly cheaper wooden construction which would then, however, have to be remade a number of times.

This is why wood is still used when the formwork is only going to be used a limited number of times.

The use of wood and wooden sections often makes it easier to achieve a given surface structure, particularly when this is not flat, but moulded and contoured in different ways.

Wood and steel can still be used together when for example an existing steel-frame formwork element is used as a carrying frame for a wooden formwork insert.



*Pre-fabricated wall formwork*

*The Athlete formwork elements form the load-bearing scaffolding for the insert formwork of a pierhead with various wall thicknesses, slopes and necks.*



*Bypass road Hettstedt; Fa. Umwelttechnik u. Wasserbau, Emsleben*



## Shaft formwork

There are shafts, or shaft-like components in the most varied forms, dimensions and types. Lift shafts, stair-well cores, wet area rooms, small containers or separators are often constructed directly on site as a one-off or in small quantities in site-mixed concrete, while large numbers are frequently produced, often with special formwork, in a concrete pre-fabrication factory. PASCHAL can develop suggestions for formwork according to project and put them forward to minimise work involved in assembly, erection and dismantling formwork, and thus saving time. Particular requirements in respect of surface quality, or the number and positioning of ties will naturally be taken into account. This task is specially interesting when it comes to shuttering several similar building components at the same time with adjustable or kit-built formwork. It is often possible to use system parts in conditions like these, with the addition of special parts.



*The manual dismantling mechanism can be actuated via a spindle system.*



*Tieless steel formwork for shafts and light wells with top and bottom shape as extension.*



*Two corner pieces of a column formwork unit are connected to each other with a hinge.*



*Several different sizes are constructed with one single formwork unit.*



## Special column sections



Special column forms with various cross-sections for PREbeton Zrt., HUN-Erdőtelek



Circular columns with conical shape; mounted working platforms with ladders as access serve for security during forming, dismantling and pouring concrete. Hotel „Bell Rock“ Europa-Park Rust; Implenia Bau GmbH, D-Rümmingen



Hexagonal columns – bridge construction Moscow; LLC TransKapStroy, Moscow



Leg with recess





## Tunnels and domes

In some cases, just a few custom parts are needed to turn system components into custom formwork. Short tunnels and all different radii of domes can be produced using the standard panels of the Trapezoidal Girder Formwork. The supporting structure consists of aluminium shoring system components from PASCHAL. Your advantage here: all standard parts are also available for rent. PASCHAL's custom formwork department proceeds with planning and pre-assembly. Trained fitters are then available on request on the job site for rapid, trouble-free operations.



*Euro Industrial Park, Munich; L. Moll, Munich*

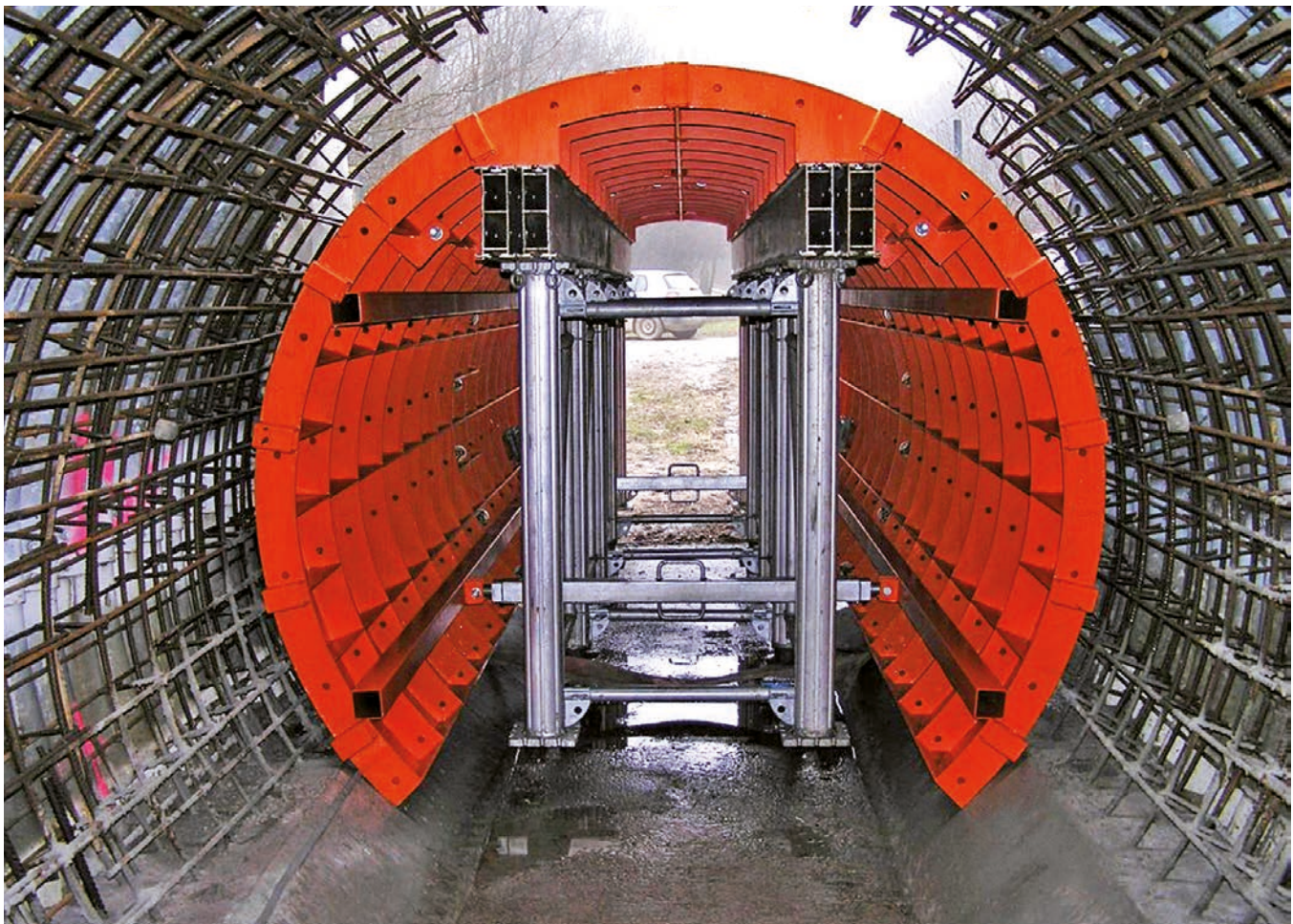

*Formwork carriage – foldable formwork with GASS shoring system*





Construction of new terminal, Frankfurt Airport; Adolf Lupp GmbH & Co. KG AV/BL

CAD-assisted planning, precise-fit production, easy-to-transport pre-assembly and punctual delivery – you can rely on all these advantages with the PASCHAL custom formwork department. And on request, PASCHAL can also delegate its fitters for rapid, troublefree procedures on the building site.



Mushroom head formwork – National theatre Darmstadt (white concrete)



# PASCHAL Maturix





## Intelligent concrete monitoring in real time

During the concreting process, the involved parties are confronted with many challenges: A lack of real-time insight into the concrete maturity status, time-consuming data acquisition and processing as well as error-specimens prevent a swift and smooth concreting process.

PASCHAL Maturix is the solution for this!

An analysis of the concrete strength is carried out by means of intelligent, wireless radio transmitters – this allows both improved planning and real-time monitoring independent of location and time.

## PASCHAL Maturix

### Intelligent concrete monitoring in real-time

Thanks to real-time monitoring, PASCHAL Maturix facilitates the efficient concreting process and, at the same time, provides well-founded evaluations.

### Save time, reduce costs

Based on the real-time analysis of the concrete strength, the optimal time for dismantling is determined. As a result, the number of defects due to early dismantling is reduced on the one hand, and, on the other hand, there are no unnecessary waiting times during the concrete maturity phase.

The user receives a convenient notification as soon as the target value has been reached or if there is too much difference in the internal temperature.

In order to guarantee the best possible concrete quality, the concrete temperature can be controlled and adjusted from any location by means of heating and cooling systems.

### Increased production output

The transmission of the required curing time of the monitored concrete allows for better planning and optimal use of capacity.



*The sensor cable is attached directly to the reinforcement and connected to the radio transmitter.*



*The sensor sends the measurement data via the Sigfox network using wireless technology.*

31

Have you already seen it?



In our application video we present all product highlights of PASCHAL Maturix. It's worth taking a look!



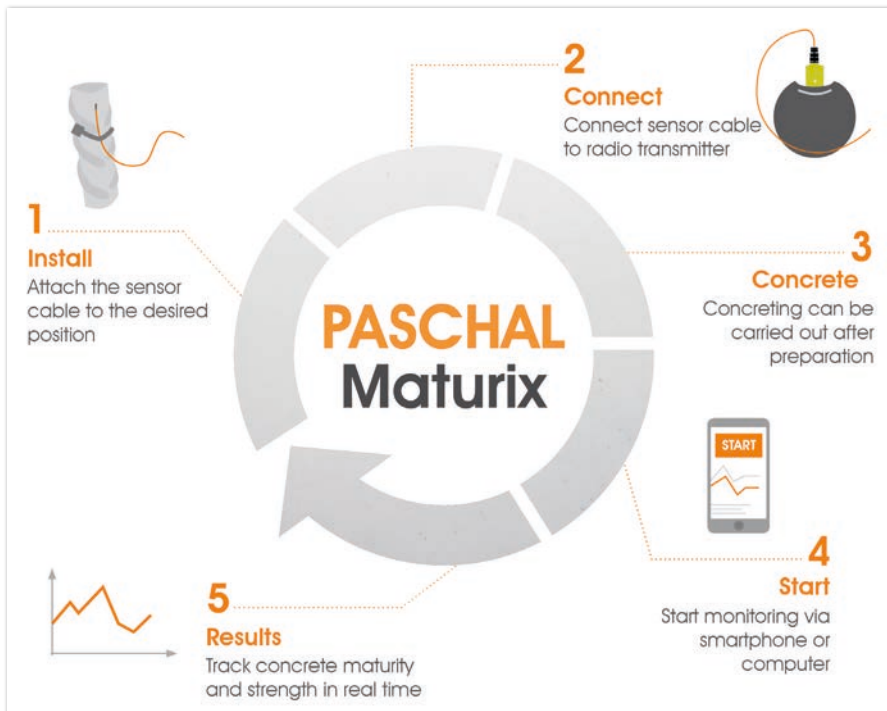

## All advantages of PASCHAL Maturix at a glance

- **Save time** - no unnecessary waiting times during the concrete maturity phase
- **Reduce costs** - Reducing the number of defects due to early dismantling
- **Increased production output** - better planning and optimal use of capacity due to transmission of the required concrete curing time
- **Real-time analysis of the concrete maturity status**
- **Simple evaluation of measurement data** - digital evaluation via the user-friendly, web-based Maturix software



Monitoring in real time via a PC or smartphone using Maturix software.

## Simple evaluation of measurement data

The Maturix software is a user-friendly web-based application that can be accessed from anywhere. Thanks to the analyses and the recorded digital documentation of measurement results, the administrative effort is significantly reduced. The well-founded data also provide the basis for decisions and serve to verify quality.

- **Workflow optimization with notifications**
- **Overview of current and completed concreting**
- **PDF downloads for documentation purposes**
- **Integration of local weather data**
- **Unlimited reports and user accounts**
- **No program installation needed (runs in browser)**



# Software

PASCHAL-Plan light + PASCHAL-Plan Pro  
planitec AR app · ERPental · checkinsite





## **Software for formwork planning:** Comfort combined with planning dependability

Planning dependability and predictable, transparent processes are indispensable for successful construction processes. The IT-specialist planitec is a member of the PASCHAL-Group who has developed modern, easy-to-use software systems for these fields of application which encompass all functions necessary for the perfect planning and organization of building processes: Starting off with automated formwork planning using PASCHAL-Plan light and continuing with differentiated AutoCAD formwork planning with PASCHAL-Plan pro, right up to using the RFID (Radio Frequency Identification) process with PASCHAL Ident for the organization and administration of modern formwork parks. PASCHAL supports its customers with PASCHAL Maturix for intelligent concrete strength monitoring in real-time.

## PASCHAL-Plan light 12.0 - Planning Software

From experts for users, from planning and construction through to completion

With IFC4 interface and complete warehouse management

The formwork planning and warehouse management software PASCHAL-Plan light (abbreviated to PPL) supports every architect, project manager, building contractor or planning engineer in large building firms so that the use of formwork can be planned to the very best and the site can be supplied in due time with the necessary and available equipment in the warehouse.

The latest version PPL 12.0 now possesses three important interfaces for importing and exporting of data: DXF, DWG and IFC4. The reading in of 3D model data and fully automatic formwork planning with all PASCHAL formwork systems is now a reality and this represents a new feature in terms of formwork software.

- JAVA-technology
- Platform independent
- Simple application
- Fully automatic formwork planning with the possibility of individual adaptation
- Up to 50,000 formwork elements can be represented in detail in one model
- Integrated data interfaces for importing and exporting: DXF, DWG and IFC
- Manufacturer-independent formwork planning
- Mobile data use
- Optimised slab module in accordance with DIN EN 1065
- Interface to the planitec AR app
- Complete warehouse management (formwork, building devices, building machines, accessories, etc.)
- Clear site management (delivery, return, stock controlling)
- As standard available in the German and English languages

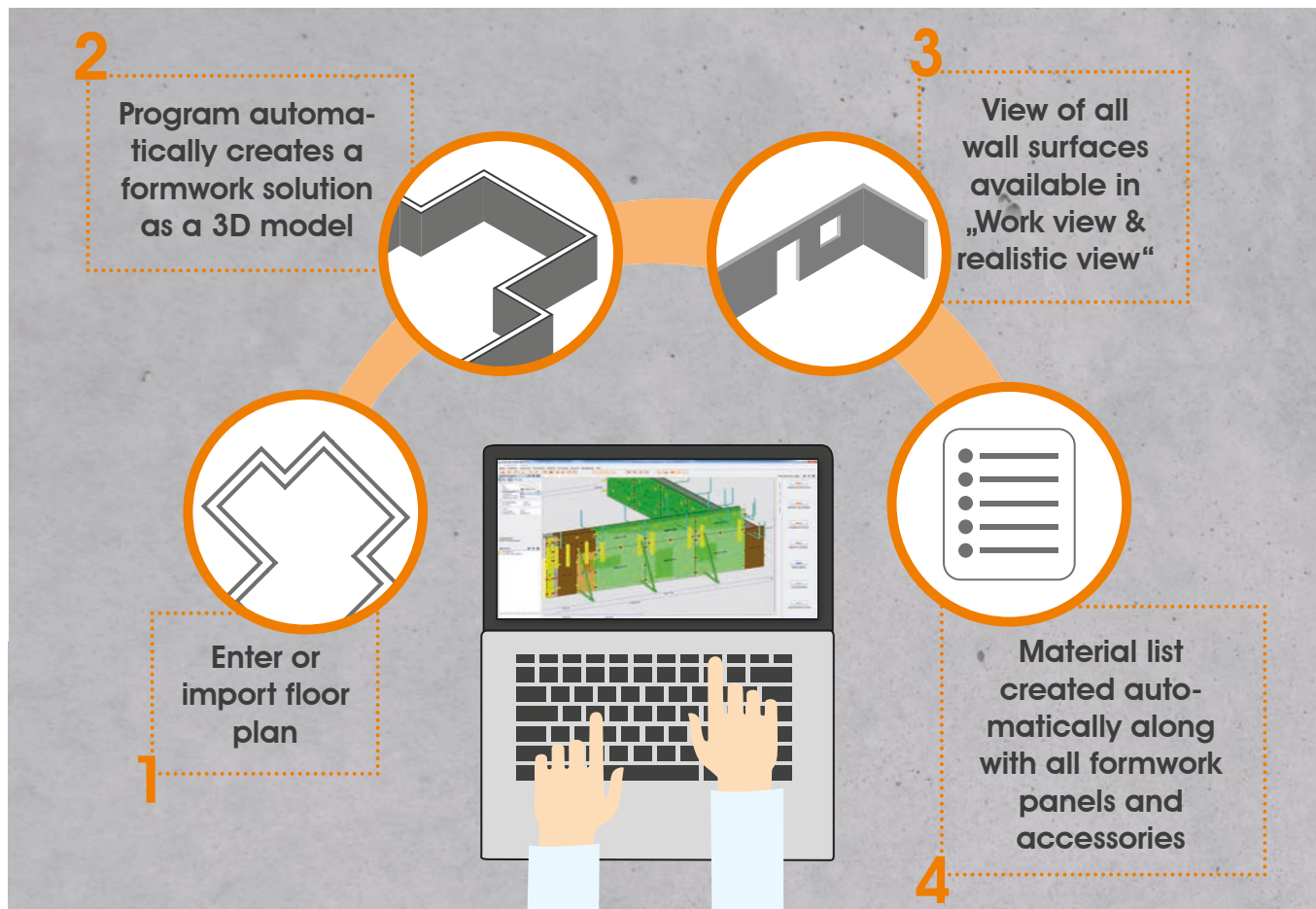



# Complete formwork planning and warehouse management with

## PASCHAL-Plan light

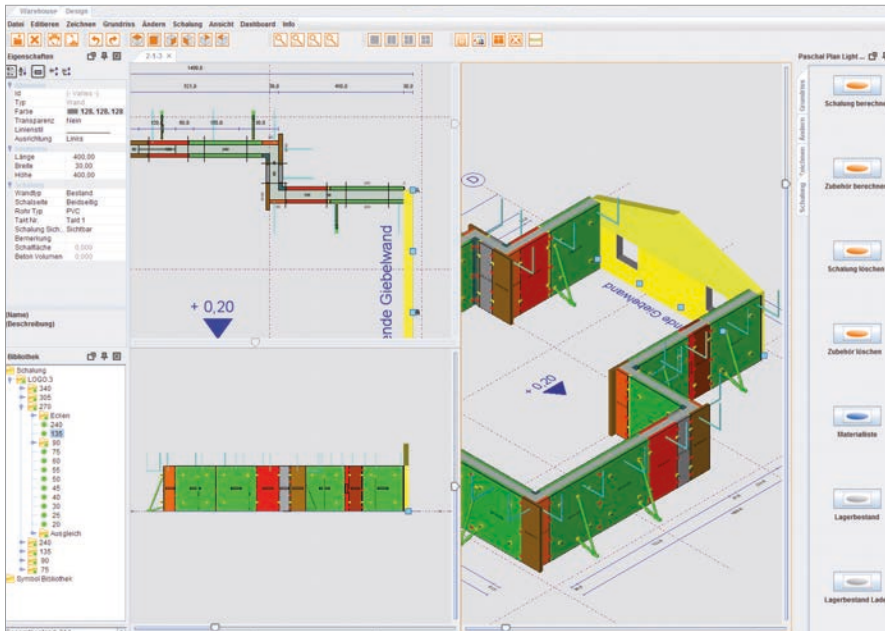

The more challenging a building project, the more challenging the necessary work planning. PASCHAL-Plan light is the perfect tool for that. Exact, clearly organized formwork drawings and an optimal material planning help making the work on your building site more reliably and quickly. You save time and money.

### Simple layout input

No knowledge in CAD is necessary. Many functions are practically self-explanatory. You can design your first simple object with just a few clicks. Of course automatically in 3D! Even complex layouts will soon hold no secret for you. Created or provided layouts or models can be quickly imported and exported via the integrated interface. This saves time and avoids potential errors.

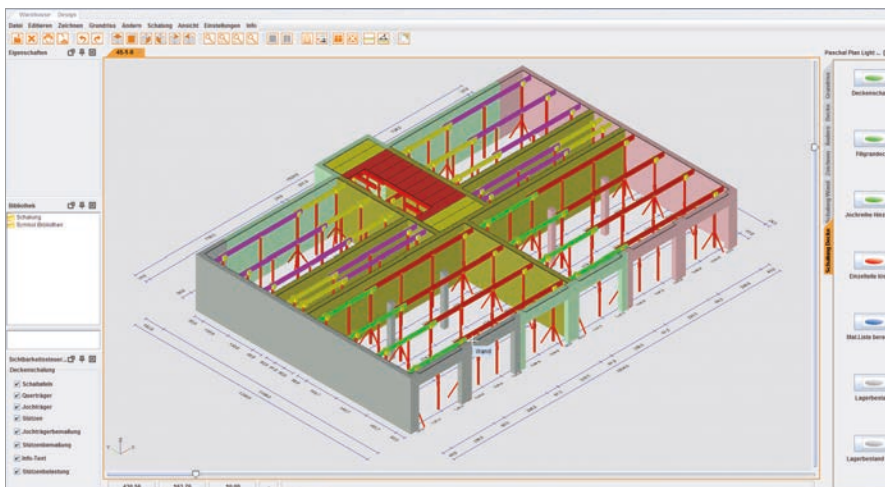

### Material lists

After you have entered the layout and selected the formwork system, PPL calculates the optimum positioning of formwork panels for your project and draws up a complete list of all necessary materials. Also for different formwork phases or the whole building.

### Concreting phase information

On the basis of the so-called concreting phase information, PPL calculates important data that you need such as formwork surface, formwork weight, concrete volumes, forming times, for all as well as ceilings.

### Manual editing

You can edit automatically created formwork plans at any time. PPL 12.0 allows manual editing of formwork elements and accessory parts.

PASCHAL-PLAN light 10.0 / (Server:localhost)

Warehouse Design

Projekt: Planen | Listen | Lagerbestand

Zielen pro Seite: 418 | Seite 1 von 1 Seiten (86) | Seite

Artikel	Bezeichnung	Verhaltung	Takt1	Takt2	Takt3	Takt4	Takt5	Takt6	Takt7	Takt8
176.001.0200	Logo-3 Element 20x270cm	4	2	2	2	0	2	2	0	0
176.001.0250	Logo-3 Element 25x270cm	4	4	0	2	0	2	0	0	0
176.001.0300	Logo-3 Element 30x270cm	3	2	0	0	2	0	2	0	0
176.001.0400	Logo-3 Element 40x270cm	4	2	0	4	2	0	0	0	0
176.001.0450	Logo-3 Element 45x270cm	2	0	2	0	0	0	2	0	0
176.001.0500	Logo-3 Element 50x270cm	6	2	3	6	3	0	0	0	0
176.001.0550	Logo-3 Element 55x270cm	4	4	0	0	0	2	2	0	0
176.001.0600	Logo-3 Element 60x270cm	4	0	2	4	2	0	2	0	0
176.001.0750	Logo-3 Element 75x270cm	6	2	3	6	2	2	3	0	0
176.001.0900	Logo-3 Element 90x270cm	6	4	2	2	0	0	0	0	0
176.001.1350	Logo-3 Mallelement 135x270cm	10	8	8	6	4	0	10	0	0
176.001.2400	Logo-3 GE Element 240x270cm	24	24	12	22	16	22	18	0	0
176.004.0900	Logo-Mallelement 90x270cm	18	2	1	16	15	8	0	0	1
176.005.0250	Logo-Innesecke 25x25x270cm	7	7	2	4	3	0	2	0	0
176.005.0251	Logo-Auensecke 25x25x270cm	4	0	4	0	0	0	0	0	0
176.007.0001	Logo-Scharnerecke 12,5x12,5x270cm	1	1	0	0	0	1	1	0	0
176.007.0002	Logo-Scharnerecke 30x30x270cm	5	1	0	0	0	1	1	0	0
176.011.1010	Kunststoffriegel 1x270cm	8	7	5	8	4	0	1	0	0
176.011.1020	Kunststoffriegel 2x270cm	4	2	2	0	0	2	1	0	0
176.011.1030	Kunststoffriegel 3x270cm	3	1	0	2	1	0	0	0	0

## 3D models for BIM

The PPL 12.0 version makes it possible to read complete IFC models. The placement of formwork elements and accessory parts occurs automatically in 3D. Thus you can view current projects spatially from all sides. The option to edit the building structure was implemented specifically for this purpose.

## BIM-compatible

With PPL, you can exchange all the relevant geometric and formwork information with BIM programs.

## Manufacturer-independent formwork software

In addition, two panel formwork families (type 1 and type 2 system) have been implemented in the new "60/120" module. For the users of PPL 12.0 this has the unique benefit that PPL 12.0 can be used to carry out all formwork planning for all projects, meaning that only one formwork software program has to be acquired and learnt, even if using formwork systems from various manufacturers.

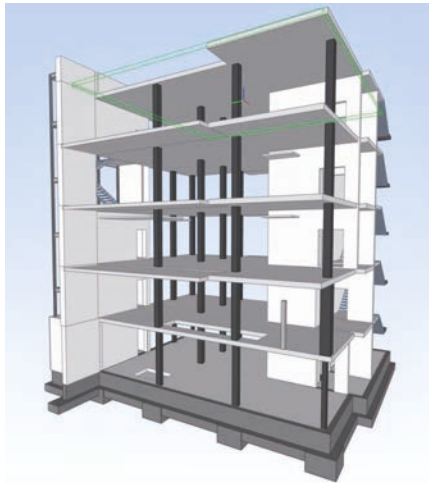

The fully automatic PPL 12.0 formwork software reads in the BIM data via the integrated IFC interface and generates the ideal formwork complete planning from the data.

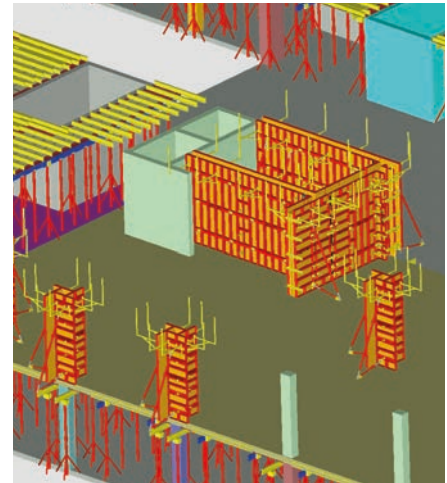

The formwork planning can be displayed, issued, calculated and kept track of section by section and in phases. In this way, work scheduling and construction management always have an overview of the construction project.

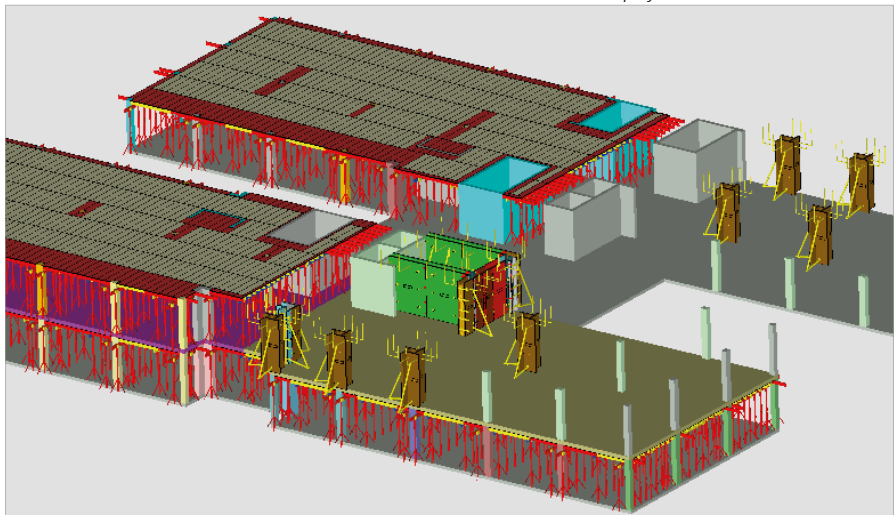

## Construction yard and site management

PPL 12.0 includes a component known as the "Warehouse" module. This module, which can also be used separately, boasts the functionality of a complete multi-warehouse management system. It enables the clear management of all construction materials, construction devices and machinery at the construction yard warehouse and at current sites.

The materials required for current projects can be compiled with just a few clicks and then delivered either fully or in part to the relevant sites.

With the same ease as delivery to the construction site, the "Warehouse" module

also enables the quick return of materials or machines to the construction yard warehouse. Simple, quick, precise.

Comprehensive reporting provides a constant overview of material stocks.

The inventory posting enables a complete inventory to be carried out at any time, including the determination of inventory differences and the valuation of stocks in the construction yard warehouse and on the construction sites.

The Warehouse module can be quickly and easily added to any existing ERP system.

Warehouse Design  
 Datei Viewer Hilfe  
 Lager Lagerbestand Lagerbewegung

Lagerart:  Adresse:   
 Name (\*):  Ort (\*):   
 Zusatz:  Strasse:   
 Land (\*):   
 Kontakt:  Telefon:   
 Email:  Mobil:   
 Bemerkung:  Fax:

1000 Zeilen pro Seite  
 Inventur

Artikelnummer	Bezeichnung
173.001.0200	Logo.3 Element 20x90cm
173.001.0250	Logo.3 Element 25x90cm
173.001.0300	Logo.3 Element 30x90cm
173.001.0400	Logo.3 Element 40x90cm
173.001.0450	Logo.3 Element 45x90cm
173.001.0500	Logo.3 Element 50x90cm
173.001.0550	Logo.3 Element 55x90cm
173.001.0600	Logo.3 Element 60x90cm



## planitec AR app

### Ideas and plans become reality with the planitec AR app

- Mobile use of digital models
- Can be used to illustrate product and user training session
- Makes optimal use of the PASCHAL products and increased safety on the construction site possible
- Available for iOS and Android

The planitec AR app makes it possible to present the planned formwork solution in original size on an area in real surroundings by means of a smartphone or tablet.

#### Mobile use of digital models

The planitec AR interface integrated in PPL 12.0 makes everything totally consistent from the 3D formwork model across all process steps through to the construction site. The result in the AR app shows the respective current state of planning – this makes formwork even easier and verifiable for the construction management team according to the current planning.

#### Mobile communication

Thanks to the integrated chat function, any questions about the formwork can be clarified directly with a PASCHAL formwork expert using the graphic display if a data connection is available.

#### For the optimal use of formwork

Thanks to the detailed visualisation, the planitec AR app can therefore also be used to illustrate product and user training sessions. It also makes optimal use of the PASCHAL products and increased safety on the construction site possible.

The PASCHAL AR app is available in the Apple AppStore and the Google Play-Store.

The planitec IT team are on hand to answer your questions on application and use.

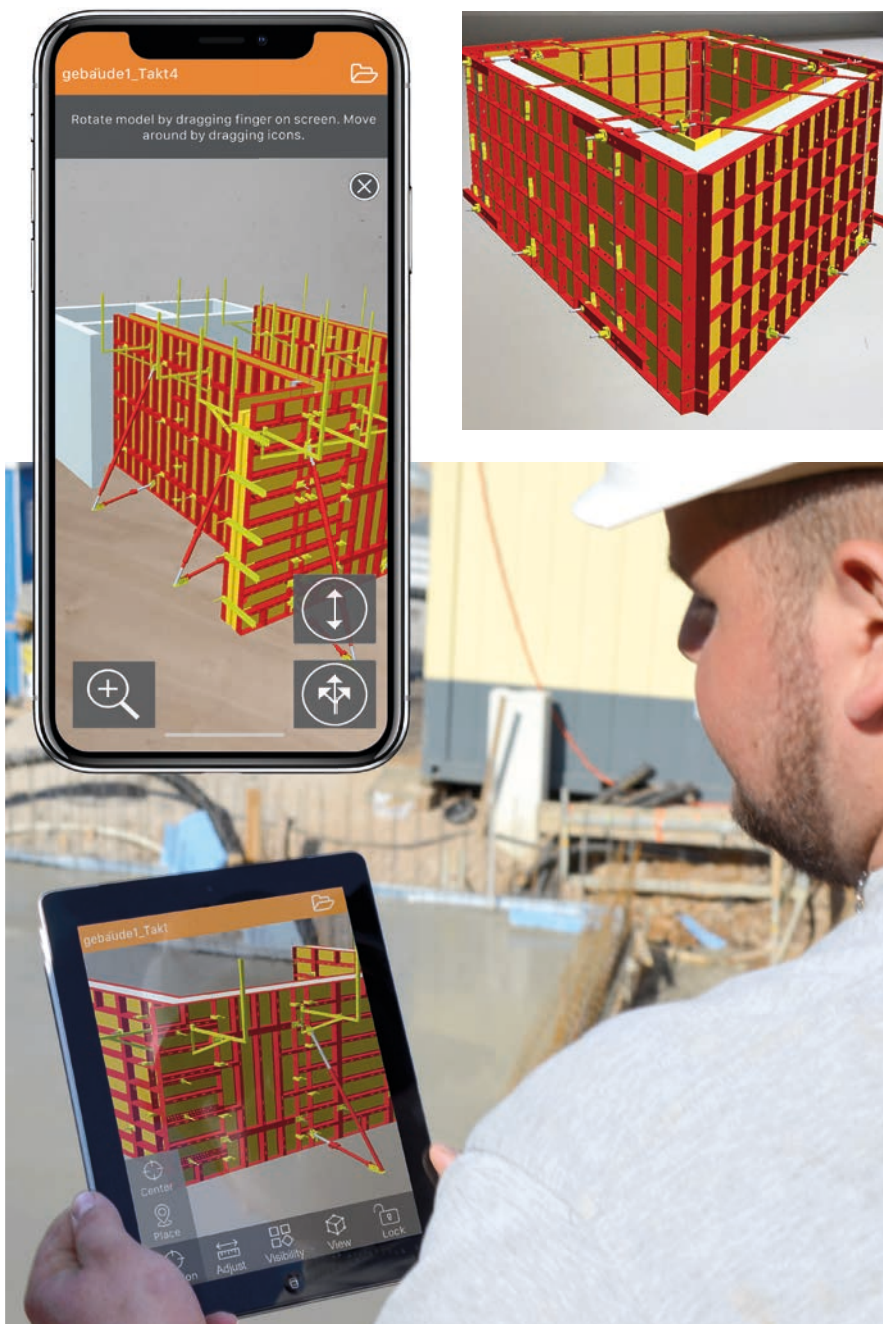

Formwork plans from PPL 12.0 can be presented as a 3D model in original size using the PASCHAL AR app.

## PASCHAL-Plan Pro - PPPro

CAD software for preparing civil engineering work

- Formwork planning
- Calculation
- Logistics
- Communication

Even an advanced formwork program like PPL is not always sufficient for problematical tasks going over and beyond normal applications. In this case application and planning engineers often work with CAD. On the basis of the architecture version of AutoCAD PASCHAL developed an application which can solve even the most difficult special cases. The program developed for this is called PASCHAL-Plan Pro.

### Compiling formwork drawings

With PASCHAL-Plan Pro you can simply adopt and edit formwork drawings which have been created in PPL; or you put the formwork together manually. You have access to all panels and can move formwork panels and all accessory parts as required. Formwork elements and accessories can only be placed in the proper positions: the „intelligent“ system is interactive, and only offers you correct solutions. This helps you to avoid errors and increases your productivity. Problems when assembling the formwork on the building site can thus be prevented. This is all made perfectly clear in the collision tests, which automatically prevent two formwork panels from overlapping, for example. Using the CAD application you can therefore move the formwork panels as on the building site and simulate the erection process. In spite of these aids, it is still important for you to have basic know-how about the formwork system being used. Building-oriented CAD works like the formwork planning engineer thinks.

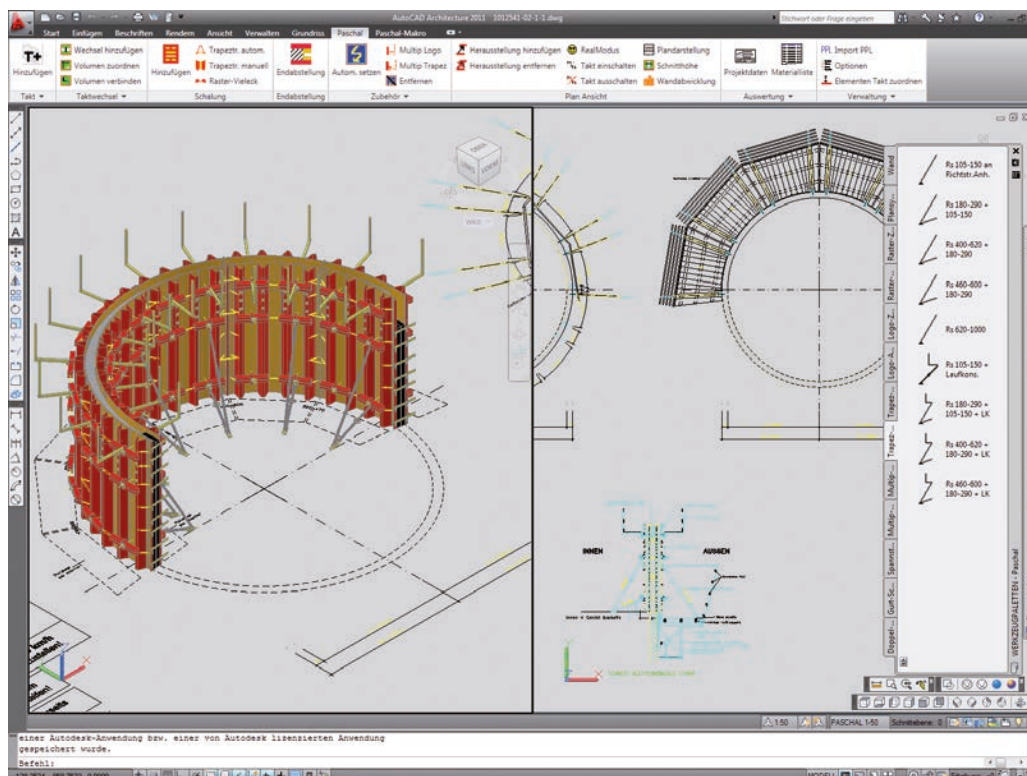
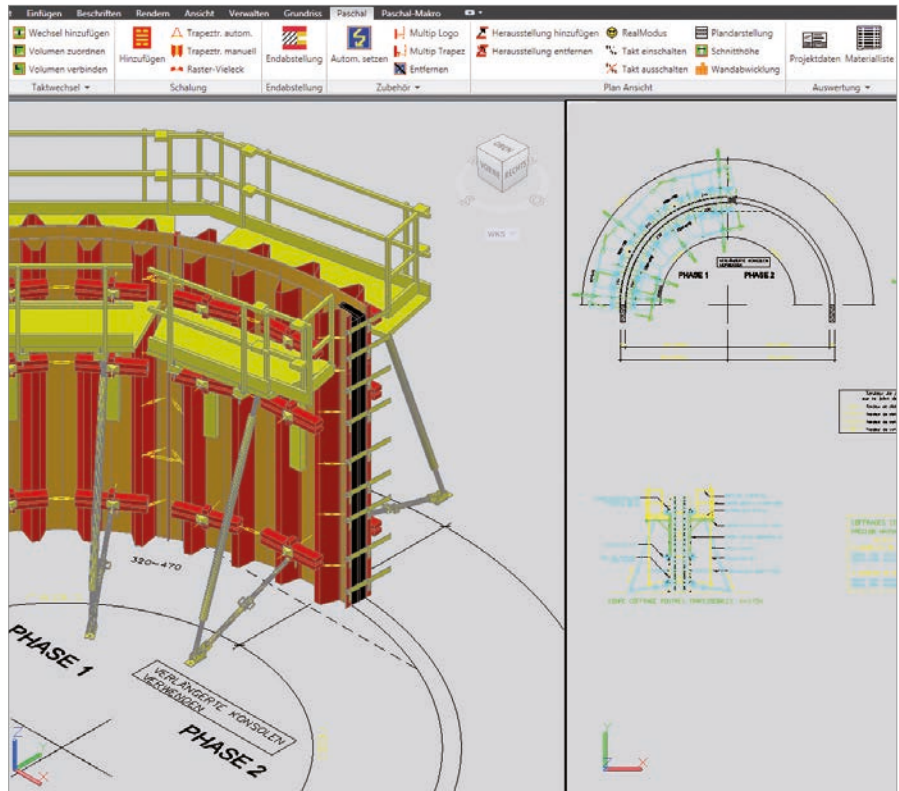



## When do you need PASCHAL-Plan pro?

Are you working on complicated building projects where you have to combine several formwork systems or with other difficult uses of formwork? Using PASCHAL-Plan pro, you can deal with such complicated structures as motorway exits, fun baths, tunnels, reservoir dams or other interesting engineering projects. On your PC you can do everything you couldn't manage with a „normal“ formwork program, including special formwork solutions. Even the supports and shoring systems are included in the object library.

## Handling

In architecture and building planning, it is normal practice to work in the layout. Users of PASCHAL-Plan pro can do this too, but also use all other views, e.g. isometry. The versatile functions of PASCHAL-Plan pro can be easily explained to the experienced AutoCAD user.

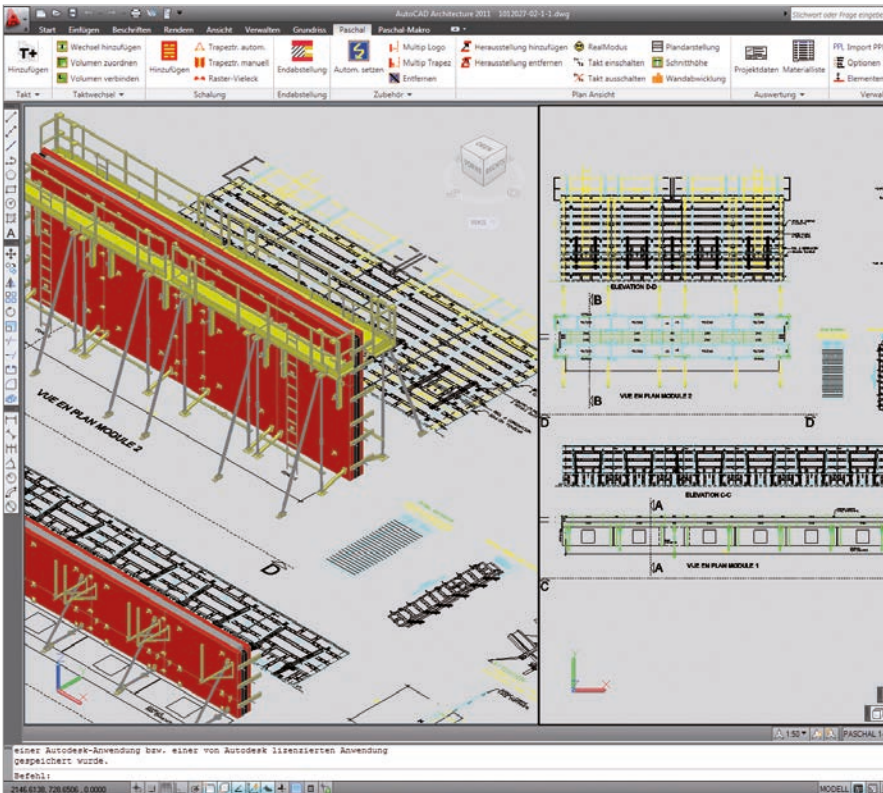

## Presentation

The best presentation for every purpose: for the building site you can create simplified, clearly organized 2D drawings which just contain the most important information for erecting the formwork. Detailed drawings in 3D for example can accurately show where an accessory part is to be fitted. PASCHAL-Plan pro can also be used to create and print coloured graphical elements for presentation purposes to create an impressive visual image of your projects.

## Interfaces

PASCHAL-Plan pro supports the main formats such as DWG, DXF and the ICF interface.

Like PPL, PASCHAL-Plan Pro of course is BIM-able too.

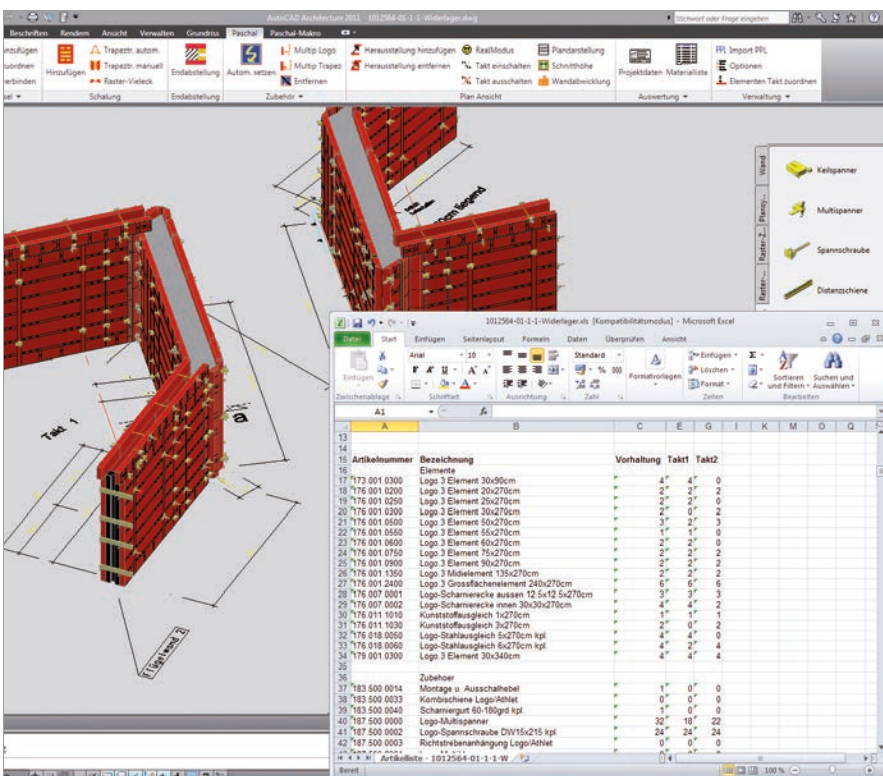

## ERPrental

### Rental software for formwork, site equipment and construction machinery

ERPrental is a module for rental of formwork, site equipment and construction machinery based on the widely used INFOR administration software.

Rental processes in these areas are growing in scope. The ERPrental software accommodates this by supporting rental processes and procedures.

The usual requirements in this sector are calculations of:

- rental at percentage rate per month
- rental per piece
- flat rate rental
- rental rate per square metre

ERPrental is designed for the manufacturer-independent management of formwork, construction site accessories, construction machinery and comparable material for companies with at least 20 employees.

The machinery module allows clear arranged administration and scheduling of construction machinery of all kinds. Furthermore operating data for machines equipped with the GPS location system "trackunit" can be fed into the machinery module in real time and called up and processed whenever required. Other positioning systems can also be integrated into ERPrental.

ERPrental can be set to German, English and French. Custom software extensions are available on request.

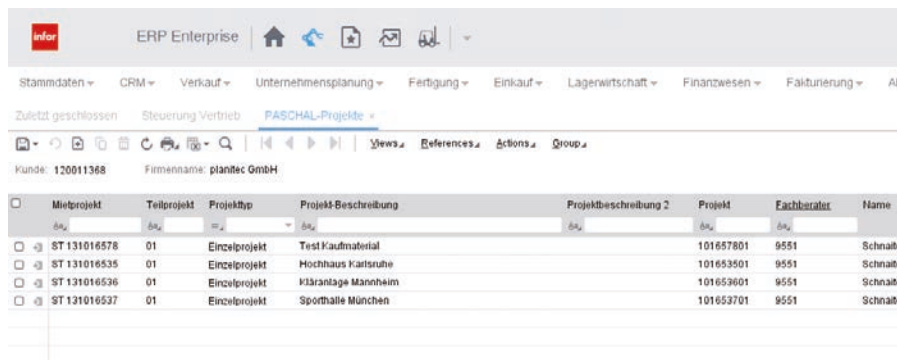
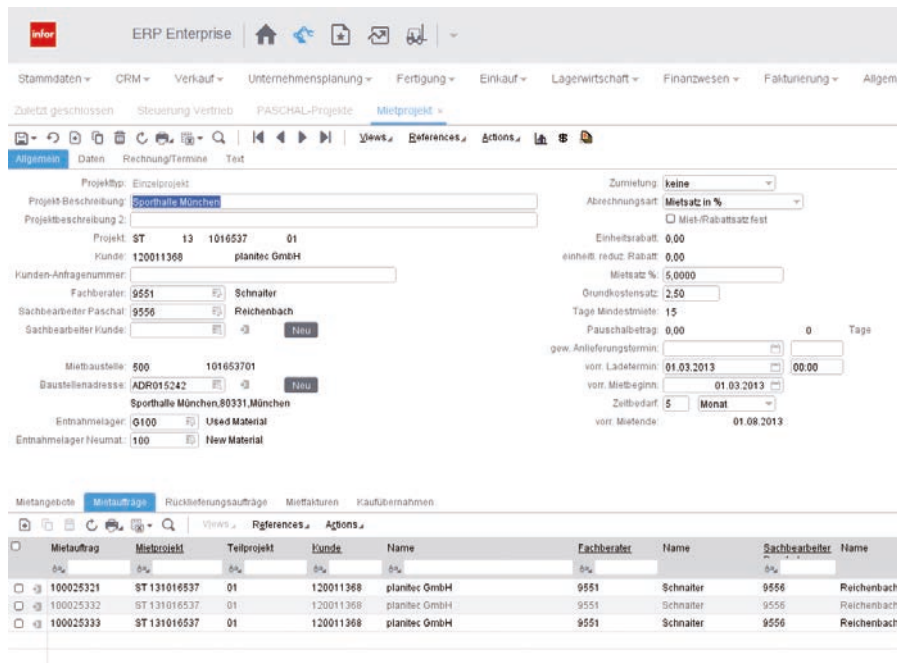

ERPrental has proven to be very flexible for the following reasons:

- At any time, customers can obtain an overview of all their materials and at which location (on what site) their inventory is currently located under what conditions.
- It is also possible to schedule several orders simultaneously. Suitable standby levels may be specified to ensure that critical inventory situations are flagged immediately.
- Missing items from returns are detected at once.
- Variations in the transactions, such as buy out of rental, are also possible without any problems; and rental fees already invoiced can also be taken into consideration.
- One main project can be broken down into several subprojects which can each be invoiced differently



# PASCHAL checkinsite

## The Online Customer Portal

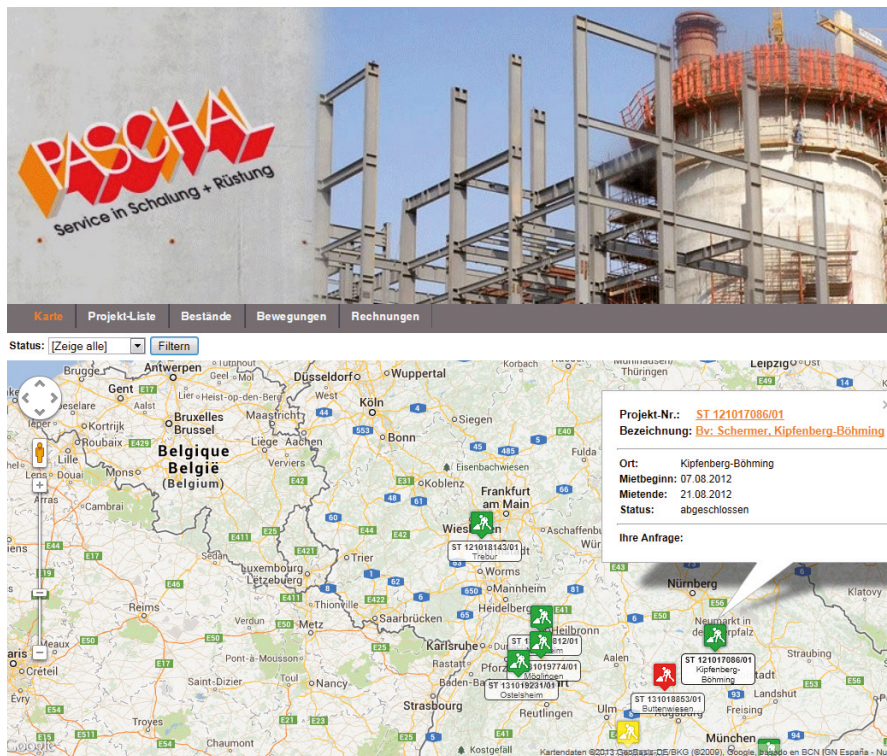

Clear access to shipping documents and daily updated overview of your construction site: The online customer portal „checkinsite“ from PASCHAL makes it possible.

### Always up-to-date

Access to up-to-date site related shipping documents and inventory.

### Archive of active and completed construction sites

With time, this creates an indispensable archive with a reporting capability for active and completed construction sites by referencing the ordered goods, while also providing up-to-date real-time documentation, flow of materials and materials lists.

### Clear history of each construction site

Providing a real-time and up-to-date comprehensible overview of the site organization, cost structure and the equipment in use.



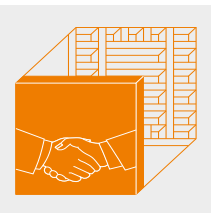

# PASCHAL Ident

Personalised Formwork





## Comfort combined with planning dependability

The PASCHAL Ident-Technology has become a world-wide success: it assigns formwork modules a discrete electronic Identification number which makes the tagged item identifiable – this is a process made possible by modern transponder technology for the first time in the field of formwork modules. PASCHAL's software provides previously unattainable planning dependability and ease of administration: these advantages are also available as an added benefit for the product lines NeoR, Modular, LOGO.3 and LOGO.pro.

PASCHAL Ident offers added benefit when it comes to financing details: transponder-tagged formwork modules may be offered as collateral to Finance Institutions for the financing of "Formwork systems including accessories".

## Benefits

### Personalised formwork

With PASCHAL Ident, each individual formwork panel is uniquely identified with its own electronic number, which is as unmissable as a human fingerprint. Absolute and accurate identification of each component is now guaranteed.

### Security

Thanks to PASCHAL Ident the formwork industry is now finally able to take advantage of benefits that were hit to only open to other industrial sectors:

- The seller is now able to offer a distinctive top product.
- The buyer is informed as to the origin and provenance of his original goods.
- The proprietor is able to clearly identify each of the panels
- The investor can effect depreciation of the formwork material for each project
- Creditors can enjoy absolute security for loans and leases
- Product liability and traceability considerably improved in line with EN ISO 9001
- The site manager is able to prove to the construction supervisor at all times that he is using the highest quality building materials
- Product fakes can be detected immediately



The reading device reading out data from the panel

### Logistics

The process of entering information is quick, uncomplicated, and unambiguous. The reading device is simply moved along the formwork panel and the relevant data is transmitted via an interface to the administrative software.

Artikel ID	Artikel Bezeichnung 1	Menge	Tatsächliche Menge	Benutzer	Datum	Gelöscht	Importiert
SS.22	<< >>	SS.22	SS.22	SS.22	SS.22	SS.22	SS.22
N179.001.0200	Logo-3 Element 20x340cm	8	3	Import	09.04.2018	No	Yes
N179.001.0400	Logo-3 Element 40x340cm	4	3	Import	09.04.2018	No	Yes
N179.001.0450	Logo-3 Element 45x340cm	8	3	Import	09.04.2018	No	Yes
N179.001.0500	Logo-3 Element 50x340cm	4	1	Import	09.04.2018	No	Yes
N179.001.0550	Logo-3 Element 55x340cm	8	6	Import	09.04.2018	No	Yes
N179.001.0750	Logo-3 Element 75x340cm	6	6	Import	09.04.2018	No	Yes
N179.001.0900	Logo-3 Element 90x340cm	4	3	Import	09.04.2018	No	Yes
N179.001.2400	Logo-3 Grossflächenelement 240x340cm	18	9	Import	09.04.2018	No	Yes
N179.005.0250	Logo-Innencke 25x25x340cm	6	6	Import	09.04.2018	No	Yes
N179.008.0001	Logo-Außencke 340cm	4	2	Import	09.04.2018	No	Yes
N179.018.0050	Logo-Stahlschleife 50x340cm	6	6	Import	09.04.2018	No	Yes
N187.500.0002	Logo-Spannschraube Ø115x215 kpl.	50	0	Import	09.04.2018	No	Yes
N187.500.0004	Logo-Verstellhammer Ø-12cm	25	0	Import	09.04.2018	No	Yes
N187.500.0005	Logo-Lau-Rolle	20	0	Import	09.04.2018	No	Yes
N187.500.0008	Logo-Überspannbügel	100	0	Import	09.04.2018	No	Yes

Database screen view – data can be put out in all standard formats (e.g. Excel)

- The data formats used are compatible for all standard applications (Excel, Access, etc.) and no expensive additional programmes are required.
- Inventories and other processes are expedited.
- For the first time, background data, such as the number of uses, can be used to obtain informative and product-relevant – not to mention profit maximising – statistics.



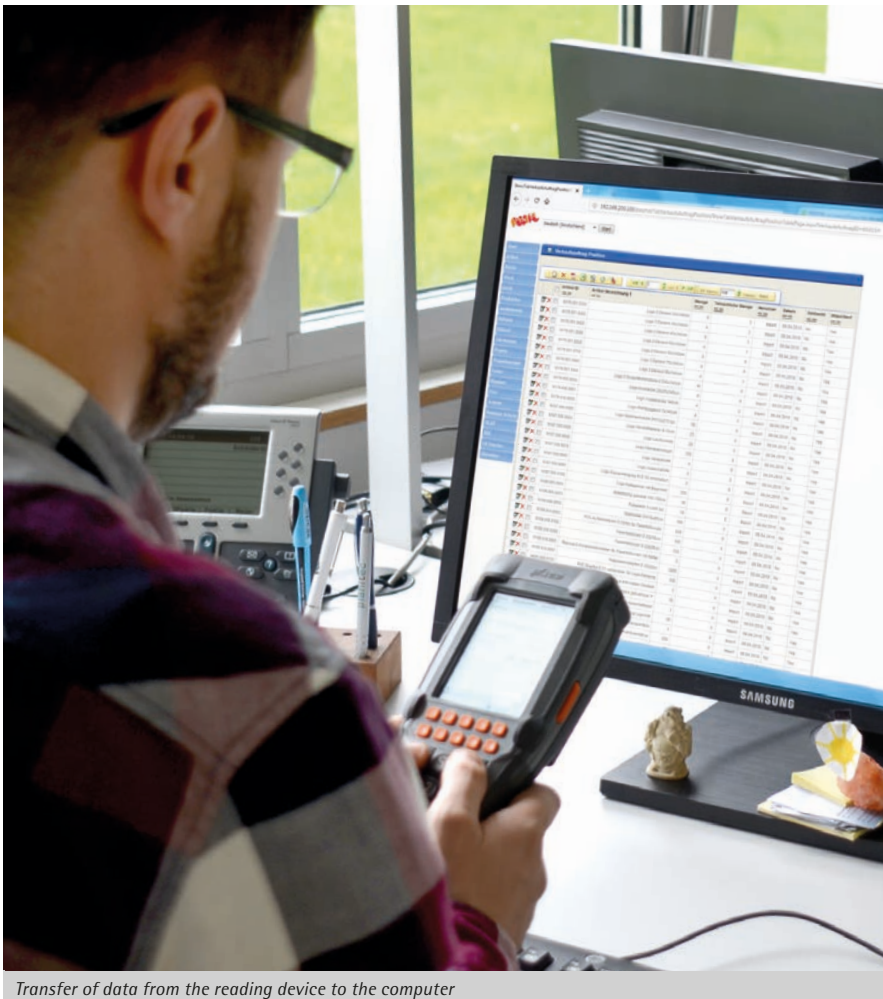

Transfer of data from the reading device to the computer

## Procedure

### A Leap in technology

The research department at PASCHAL has succeeded in creating the first ever integration of RFID technology in formwork panels. The abbreviation RFID stands for 'radio frequency identification'. The task facing the design engineers was to find a way of incorporating the sensitive electronic data storage medium in the formwork material that would enable it to withstand the everyday conditions of a building site.

### Transponder technology for the twenty-first century

The RFID technology is based on three components: the information chip integrated in the formwork-panel, the reading device, and the associated software. The combination of a chip and its special housing is known as a transponder.

It is the combination of these three components that allows to identify without physical contact, and to manage the data in whichever way it is needed. It is like each separate formwork panel has its own CV, not only comprising its name, place of production, age, and weight, but also including any other information deemed important, such as the number of uses, the technical state, and the current value of the panel.

		Produktionsauftrag externe ID	Artikelnummer	Artikel Bezeichnung 1
Seriennummer	Drucken	999999987	N679.101.0001	Seilenteil 135cm ohne Auskl. mit Transponder
Seriennummer	Drucken	999999986	N101.001.1000	Rasterelement 100x75cm
Seriennummer	Drucken	987654321	N609.102.1500	Seilenteil 150cm rechts mit Transponder
Seriennummer	Drucken	100106030	N504.009.0002	Eckelement 45grd rechts 150cm geschweisst
Seriennummer	Drucken	100106029	N504.009.0001	Eckelement 45grd links 150cm geschweisst
Seriennummer	Drucken	100106027	N104.009.0002	Eckelement 45grd rechts 150cm für Ausschalelement 20x150cm
Seriennummer	Drucken	100106026	N104.009.0001	Eckelement 45grd links 150cm für Ausschalelement 20x150cm
Seriennummer	Drucken	100106025	N104.008.0200	Ausschalelement 20x150cm
Seriennummer	Drucken	100106010	N104.001.0250	Rasterelement 25x150cm
Seriennummer	Drucken	100105963	N579.005.0250	Logo-Innenecke 25x25x340cm geschweisst

Software

### How the RFID system works

The transponders are addressed by induction (no batteries are needed). This is sufficient for it to transmit its data to the reading device. The unique identification system is cheap and absolutely accurate. And not only that, but unlike bar codes, colour spots or other similar methods, this integrated solution is resistant to building site conditions and secure against forgery.

## Positioning the transponders

- The transponders are integrated in the frame of the formwork panels
- Each panel has two integrated transponders
- The transponders are recognisable from the circular depression in the outer frame

LOGO.3 / LOGO.pro



Modular/GE / NeoR



## Advantages of using RFID technology

For the customer, RFID technology provides improved stock management, more transparency in production, lower storage costs, and simplified administration of plants.

- With the help of RFID you can automatically monitor your plants and stocks of goods. That saves time and personnel-intensive counting. RFID can also be used to make goods secure, and this way help companies even more to protect themselves against loss and waste as well as depreciations.
- Using RFID transponders simplifies the maintenance and management of plants. They make maintenance processes more transparent, reduce servicing costs, and raise plant reliability. Also, legal requirements and conditions as well as maintenance cycles can be better complied with.
- Each individual object that is given an RFID transponder has a unique identity. This makes it possible to secure and optimize the tracing of goods throughout the entire delivery chain. Legal requirements can be complied with.

## Support for management processes

- Exact stock evaluation will be possible
- Optimize the processing of returns and stocktaking
- Product traceability will be possible in case of product liability



## Leasing PASCHAL formwork



Tailor-made solutions for PASCHAL customers from leasing companies:

- Leasing secures and improves assets
- Improves the balance sheet
- Leasing simplifies ongoing rationalisation
- Leasing can be financed from the revenues of the leased goods
- Leasing supports a property-related credit assessment
- Leasing provides a safe basis for calculation
- Leasing enables individual solutions for a particular case

We are working together with financing companies to achieve this. The process is quick and easy: Your specialist takes the request for financing and passes it on to the financing company. The financing company then checks the credit rating and works out a model calculation. The contract is then concluded with the financing company.

The following contract variants may be used here:

### Full amortisation contract:

- 100% amortisation during the entire contractual period (no residual value)
- The contractual period is between 40% and 90% of the tax depreciation for wear period
- Possible options at the end of the contract:
  - You can buy the leased object at market value
  - You can extend the leasing contract
  - You can return the leased object – the leasing company shall assume the recycling

### Partial amortisation contract:

- No full amortisation during the contractual period – contract with "residual value"
- The object is accounted for by the lessor
- The contractual period is between 40% and 90% of the tax depreciation for wear period
- Example: Tax depreciation for wear period 96 months: Contract period of min. 39 months and max. 86 months
- Possible options at the end of the contract:
  - Right to offer for the leasing company
  - Extension of the leasing contract

## Modular/GE



### Modular/GE Universal Formwork

Universal formwork for foundations, walls, supports, beams, shafts, round solutions (polygons), gardening and landscape construction, precast elements.

- Designed for hand-set applications as well as crane dependant large-size formwork
- Modular design principle and well-balanced panel selection make gang-forming possible even for complicated layout plans
- Flat steel frame for guaranteed sturdiness and a long product life cycle
- Compatible with all PASCHAL systems
- Keybolt as a universal means of connection for all panels and accessories

#### Technical data

##### Panel widths [cm]

Modular: 100/75/60/50/45/43/40/37/35/33/30/25/24/20/15/12/10/6/5; GE: 200/150

##### Panel heights [cm]

Modular: 150/125/75/62,5; GE: 275/250/150/125

##### Frame depth [cm]

Modular 7,5; GE 19,5 (7,5 + 12 Girder)

##### Plywood

15 mm thick, 11-ply Finnish birch plywood

##### Max. concrete pressure

Modular: 35 kN/m<sup>2</sup> according DIN 18218  
GE: 60 kN/m<sup>2</sup> according DIN 18218

##### Tolerances of deflection

Modular: According DIN 18202, table 3, line 6  
GE: According DIN 18202, table 3, line 7

## NeoR



### NeoR Lightweight formwork

Due to the low weight (30 kg/m<sup>2</sup>), the NeoR can be moved easily by hand. Universal fields of application: Foundations, columns, beams, walls.

- Height offset of the panels can be performed via oblong holes in the panel frame
- Keybolts as lightweight, friction-locked and cost-effective connecting pieces
- Easy attachment of accessories using the hook head principle
- The structural height is just 7.5 cm → low storage and transport volume
- The flat steel frame guarantees robustness and durability

#### Technical data

##### Panel widths [cm]

90 / 75 / 60 / 45 / 30 / 15

##### Panel heights [cm]

150 / 90

##### Large-size panel [cm]

180 x 300

##### Frame depth [cm]

7,5 cm

##### Plywood

12 mm Birkenperrholz

##### Max. concrete pressure

50 kN/m<sup>2</sup> according DIN 18218

##### Tolerances of deflection

According DIN 18202, table 3, line 6

## LOGO.3



### Wall Formwork LOGO.3

Large-size system for residential and commercial buildings, industrial construction, civil engineering, reservoir construction.

- Small number of ties (0.62 ties/m<sup>2</sup>)
- Quick panel connection with wedge clamps (only 1.8 kg in weight)
- Profiled flat steel frame for guaranteed sturdiness and long product life span
- Quick accessory fastening on multi-functional cross profiles
- Vertical or horizontal deployment for all panels
- Multi-purpose panel for corners, columns, stop ends
- Well-balanced panel selection

#### Technical data

##### Panel widths [cm]

340/240/135/90/75/60/55/50/45/40/30/25/20

##### Panel heights [cm]

340/305/270/240/135/90/75

##### Frame depth [cm]

12

##### Plywood

16 mm thick, 11-ply Finnish birch plywood

##### Max. concrete pressure

70 kN/m<sup>2</sup> according DIN 18218

##### Tolerances of deflection

According DIN 18202, table 3, line 6



## LOGO.alu



Wall Formwork LOGO.alu

Light-weight formwork for construction sites without cranes and fully compatible to LOGO.3 with steel frame.

- Quick panel connection with wedge clamps (only 1.8 kg in weight)
- Solid frame profile for guaranteed sturdiness and longevity
- Panel 90 x 270 cm = only 60 kg weight and 2 ties for that height
- Quick accessory fastening on multi-functional cross profiles
- Compatible with LOGO.3 with steel frame
- Multi-purpose panel for corners, columns, stop ends

### Technical data

**Panel widths [cm]**  
90/75/60/55/50/45/40/30

**Panel heights [cm]**  
270/135

**Frame depth [cm]**  
12

**Plywood**  
16 mm thick, 11-ply Finnish birch plywood

**Max. concrete pressure**  
60 kN/m<sup>2</sup> according DIN 18218

**Tolerances of deflection**  
According DIN 18202, table 3, line 6

## LOGO.pro



Wall Formwork LOGO.pro

The innovative formwork solution LOGO.pro can be anchored either from just one side or in the conventional manner.

- Tie-points can be operated by one person/fully operable from one side
- Time and cost savings
- Use of standard tie rods and therefore no expensive special tension bars required
- Tubes are freely selectable
- No time-consuming staking of the anchor bars
- Compatible with LOGO.3 and LOGO.alu
- Orderly joints and anchors with visually appealing concrete surfaces

### Technical data

**Panel widths [cm]**  
240/90/60/45/30

**Panel heights [cm]**  
vorerst 270

**Frame depth [cm]**  
12

**Plywood**  
16 mm finnisheses Birkensperrholz, 12-schichtig

**Max. concrete pressure**  
70 kN/m<sup>2</sup> according DIN 18218

**Tolerances of deflection**  
According DIN 18202, table 3, line 6

## LOGO.S



Wall Formwork LOGO.S with steel facing

Large-size system for residential and commercial buildings, industrial construction, civil engineering, reservoir construction.

- Panels with foldable, integrated working platforms and accessories → time-saving during assembly
- Inside corner post 25 x 25 x 270 cm to form rectangular wall constructions
- Walls up to 265 cm height with only 0,3 ties/m<sup>2</sup> in concrete, due to tie point at edge of the panel frame
- No impressions of bolts or rivet heads (perfect concrete finish)
- Stepless height offset of panels is possible easily due to clamp connection
- Completely compatible with LOGO.3

### Technical data

**Panel widths [cm]**  
240/135/90

**Panel height [cm]**  
270

**Frame depth [cm]**  
35,5 (incl. folded platform)

**Steel sheet**  
5 mm steel or magnetic stainless steel sheet

**Max. concrete pressure**  
100 kN/m<sup>2</sup> according DIN 18218

**Tolerances of deflection**  
According to DIN 18202, table 3, line 6

## TTR



Trapezoidal Girder Formwork with plywood  
Circular Formwork with adjustable radii for waste water treatment plants, container construction, water parks, towers, stairwells, garage entrances, gardening and landscaping.

- Infinitely adjustable for diameters from 2 - 5 meters, and 5 meters to infinite
- Only 0.28 - 0.55 ties/m<sup>2</sup>
- Delivered ready to use to the construction site
- Perfectly round and with exact dimensions
- System solutions for haunch girders and uneven surfaces
- Compatible with all PASCHAL systems

### Technical data

#### Segment widths [cm]

125,5/110,5; 62,5/55,5 (ø 2 - 5 m)  
240/230 (222); 120/115; 60/57,5 (ø 5 - ∞)

#### Segment heights [cm]

300/150/75/37,5

#### Frame depth [cm]

40 (straight condition)

#### Plywood

18 mm (ø 2-5 m); 21 mm (ø 5-∞)

#### Max. concrete pressure

60 kN/m<sup>2</sup> according DIN 18218

#### Tolerances of deflection

According DIN 18202, table 3, line 7

## TTK



Trapezoidal Girder Formwork with clamp connection  
Circular Formwork with adjustable radii for waste water treatment plants, container construction, water parks, towers, stairwells, garage entrances and landscaping.

#### Advantages of clamp connection:

- Less connecting pieces
- Fast segment connection
- Clamps can be "stored" at the segment
- Stepless segment positioning with height offset

### Technical data

#### Segment widths [cm]

240/230; 120/115; 60/57,5 (ø 5 - ∞)

#### Segment heights [cm]

300/150/75/37,5

#### Frame depth [cm]

40 (straight condition)

#### Plywood

21 mm (ø 5-∞)

#### Max. concrete pressure

60 kN/m<sup>2</sup> according DIN 18218

#### Tolerances of deflection

According DIN 18202, table 3, line 7

## TTS



Trapezoidal Girder Formwork with steel facing  
Circular Formwork with adjustable radii for waste water treatment plants, container construction, water parks, towers, stairwells, garage entrances, gardening and landscaping.

- For fair-faced concrete - perfect concrete finish (no bolt impressions)
- Infinitely adjustable for diameters from 5 meters to infinite
- Only 0.28 - 0.55 ties/m<sup>2</sup>
- Delivered ready to use to the construction site
- Integrated crane lifting clamps
- Perfectly round and with exact dimensions
- System solutions for haunch girders and uneven surfaces

### Technical data

#### Segment widths [cm]

240/230; 120/115; 60/57,5

#### Segment heights [cm]

300/150/75

#### Frame depth [cm]

40 (straight condition)

#### Steel sheet

#### Max. concrete pressure

80 kN/m<sup>2</sup> according DIN 18218

#### Tolerances of deflection

According DIN 18202, table 3, line 7



## Grip



**Adjustable columns formwork Grip**  
Adjustable column formwork with excellent forming times for highest quality fair-faced concrete formwork.

- Setting and stripping of formwork requires only the the fastening and then unfastening of ties at one corner
- Relocation via a single crane lift (folding mechanism)
- Easy installation of concreting platform and push-pull props
- Low transport volume due to foldable mechanism

### Technical data

**Panel heights [cm]**  
340/300/150/90

**Adjustable range**  
20-60 cm, in 5 cm steps

**Plywood**  
21 mm plastic covered birch plywood

**Max. concrete pressure**  
80 kN/m<sup>2</sup> according DIN 18218

## Circular

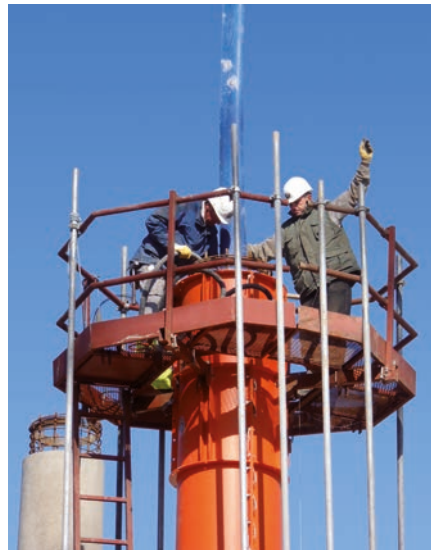

**Circular column formwork**  
Steel formwork for round and oval shaped columns.

- Leakage free panels joints due to overlapping formwork lining
- Oval columns and rounded stopends by be using the Modular connection panel
- Complete with work platform for safe concreting
- Many deployments, no disposal costs
- No limits to concreting speed at small diameters

### Technical data

**Panel heights [cm]**  
300/275/150/125/75

**Diameter [cm]**  
100/90/80/70/60/50/45/40/35/30/25

**Plywood**  
3 mm steel sheet

**Max. concrete pressure**  
85 kN/m<sup>2</sup> according DIN 18218 (ø 100 cm)  
335 kN/m<sup>2</sup> according DIN 18218 (ø 25 cm)

## Modular column formwork



**Modular column formwork adjustable**  
The adjustable modular column formwork by PASCHAL is a steel frame formwork whose elements are assembled according to the so-called windmill principle.

- With four elements each square and rectangular column cross-sections can be formed in the adjustment range of 20 cm to 50 cm in increments of 5 cm.
- Mounting options for accessories such as props, platform brackets or crane lifting clamps are available in the elements.
- With increased demands on the concrete surface (edges) at the panel joints, a glazing tape or chamfer strip can be mounted.

### Technical data

**Panel width [cm]**  
60

**Panel heights [cm]**  
150/125/100

**Frame depth [cm]**  
7,5

**Plywood**  
15 mm, phenolic resin coated plywood

**Max. concrete pressure**  
60 kN/m<sup>2</sup> according to DIN 18218

## PASCHAL Deck



Slab formwork

Versatile slab formwork for ceilings in residential and industrial buildings.

- Small number of individual parts
- Optimised material deployment
- For any slab thickness
- Length adjustment through overlapping of girders
- Light-weight individual parts
- Optimised adjustment to any layout
- Any formwork covering selectable

### Technical data

**Girder length [cm]**  
600/490/390/360/330/290/245

**Girder height [cm]**  
20

**Maximum load of the H20 girder**  
Max. shear force 11 kN  
Max. bending moment 5 kNm

## Climbing system 240



Climbing system

It supports the efficiency and cost effectiveness of climbing systems in adjusting flexibly to the structure geometry and in permitting larger formwork units.

- Can be adjusted up to +/- 15 degrees on the geometry of the structure
- High load-bearing capacity
- Saving of time and costs by transposing of larger formwork units
- Long service life and functionality by hot-dip galvanizing as surface protection
- High degree of safety at work by working space in front of and behind the formwork
- Little transport volume by modular construction
- General Construction Supervisory Approval (called abZ) from the DIBt for the anchor

### Technical data

**Bracket depth**  
2,40 m

**Live loads**  
Working platform: 4,5/3,0 kN/m<sup>2</sup>  
Concrete platform: 1,5 kN/m<sup>2</sup>  
Suspended scaffold: 1,0 kN/m<sup>2</sup>

**Inclination**  
+ / - 15°

## Climbing system 200



Climbing system

A versatile system for safe and economical climbing.

- Compatible with all Paschal formwork systems
- Climbing unit with large formwork areas can be moved in one piece
- General Construction Supervisory Approval (called abZ) from the DIBt for the anchor

### Technical data

**Climbing bracket**  
2,00 m

**Live loads**  
Working platform: 3,0 kN/m<sup>2</sup>  
Suspended scaffold: 1,0 kN/m<sup>2</sup>

**Working heights**  
up to 100 m above ground level

**Formwork heights**  
up to 5,60 m

**Anchoring**  
Clevis shoe M30 with anchor cone M30

**Accessories**  
Panel supports and height adjustment units for all PASCHAL formwork systems  
Tension anchoring for wind loads  
Traps



## KBK 180



**Climbing platform KBK 180**  
Work and jacking scaffold, which comes fully assembled and ready to use on-site.

- Compatible with all PASCHAL formwork systems
- Platform folds up for low transport volume
- General Construction Supervisory Approval (called abZ) from the DIBt for the anchor

### Technical data

**Platform width**  
180 cm

**Platform length**  
295 cm; corner platforms: 390 cm

**Bracket spacing**  
200 cm

**Maximum loads**  
3 kN/m<sup>2</sup> as climbing platform carrying formwork  
4,5 kN/m<sup>2</sup> as working platform without formwork  
2 kN/m<sup>2</sup> as working and safety platform with drop-in loop according to DIN 4420

**Anchoring**  
Clevis shoe M30 with screw anchor M24 or anchor cone M30  
Drop-in loops according to DIN 4420

**Accessories**  
Corner platforms, single brackets, connection part for drop-in loops, clevis shoe M30, bracket extensions, railing posts for lateral protection, suspended scaffold, traps, Drop-in loops as per DIN 4420

## Secuset



**Reliable lateral protection according to safety standard EN 13374**

A key element is the railing post lateral protection, which can be used for a range of applications when combined with various connecting parts. Thanks to the flexible application of the lateral protection system, you will save on investment and storage costs.

- For a variety of applications (wall formwork, slab formwork, window and door openings, concrete slabs and exposed slab edges and upper wall edges)
- Quick, easy assembly
- According to safety standard EN 13374
- Use with a protection fence or wooden planks is possible

### Technical data

**Connecting parts for PASCHAL formwork systems**  
Support LOGO / NeoR / Modular / GE for Secuset

**Other fastenings**  
Fastening plate Secuset, Clamping piece Secuset

**Dimensions lateral protection fence [cm]**  
260 x 118 / 230 x 80 / 130 x 80

**Platform brackets**  
Platform bracket Secuset LOGO / NeoR / Modular

## Multip



**Multi-functional working platform Multip**  
The multi-functional working platform with highest safety standards.

- Formwork and scaffolding is delivered to site preassembled
- No additional installation of individual service-brackets, covers and guard rails
- Time saving due to folding mechanism
- Full compliance with all building code requirements (BGR 187)
- Safe workplaces allow quicker operation of accessory parts, like connection parts and ties
- Significantly longer lifespan, than traditional wood covering

### Technical data

**Platform width**  
LOGO.3 and Athlete 72 cm;  
Trapezoidal girder formwork 85 cm

**Platform length**  
LOGO.3 and Athlete 240 / 135 cm;  
Trapezoidal girder formwork external 238 cm, internal 210 cm, (D ≥ 7,00 m)

**Adm. load**  
2,0 kN/m<sup>2</sup>

## Custom Formwork



Custom formworks for construction components, where system formwork can only be utilised partially, or not at all.

- Any geometry or surface can be formed
- Made for highest quality standards
- Shaft formwork
- Special column sections
- Tunnels and domes
- Wood and steel custom formwork

## GASS



Aluminium shoring system GASS

Alu shoring system for the distribution of weight from great heights in all areas of construction.

- Shoring system, climbing scaffolding, stacking tower, individual column
- Light-weight components
- Only one support up to a height of 6.5 m
- Highly flexible due to 8 connection points on supports
- Quick splined connection for frame/support
- Frame height 1 m usable as security railing at full area live load of 1.5 kN/m<sup>2</sup>
- Can be used as slab table with crane
- General Construction Supervisory Approval (called abZ) from the DIBt

### Technical data

#### Dimension

Support lengths: 467 / 358 / 249 / 140 cm  
Frame widths: 120 / 180 / 240 / 300 cm

#### Max. load

Max. load per leg 140 kN

## PASCHAL TG 60



Shoring Tower TG 60

The shoring frames TG 60 are made of steel tube of higher strength and are stiffened with 2 small diagonal braces.

- Use as shoring system, stacking tower and slab table
- Low weight of individual parts
- Saving in time during assembly and dismantling thanks to bolt-free connection technology
- Safe and simple assembly via integrated access
- Tried and proven range of parts and accessories
- Convincing economic and versatile design
- As unit movable by crane and castors
- General Construction Supervisory Approval with structural calculations proven by DIBt

### Technical data

#### Dimension

Support lengths: 50 / 71 / 100 cm  
Frame width: 109 cm  
O-ledge lengths: 109 / 157 / 207 / 257 / 307 cm

#### Max. load

Max. load per leg: 60 kN



## PASCHAL Maturix



Smart concrete monitoring in real-time

Thanks to real-time monitoring, PASCHAL Maturix facilitates the efficient concreting process and, at the same time, provides well-founded evaluations.

- Save time, reduce costs
- Earlier dismantling by determining the optimal point of time
- Control and adjust the concrete temperature from any location
- Increased production output
- Real-time insight into the concrete maturity status

## PPL 12.0

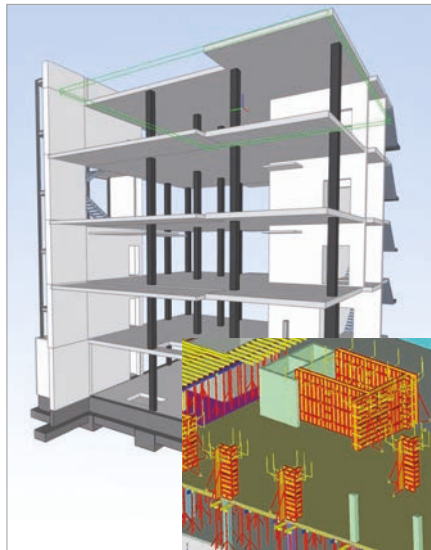

PPL 12.0 PASCHAL-Plan light

By BIM experts for BIM users. With PPL 12.0, using the digital 3D models for work preparation, cycles and automatic formwork planning with material lists for scheduling and managing the formwork is made a reality across the board. The interface to the planitec AR app makes it possible to use in mobile form on the construction site.

- IFC interface for importing and exporting data
- Module 60/120 for manufacturer-independent formwork planning
- Fully automatic formwork planning with the possibility of individual adaptation
- Warehouse module for material transparency
- Interface to the planitec AR app

## planitec AR-App

The planitec AR app makes it possible to present the planned formwork solution in original size on an area in real surroundings by means of a smartphone or tablet.

- Mobile use of digital models
- For the optimal use of formwork

## PPPPro

PPPPro PASCHAL-Plan Pro software

CAD 3D-Software for planning of sophisticated projects.

- Formwork planning
- Calculation
- Logistics
- Communication
- AutoCAD formwork application

## PASCHAL Ident

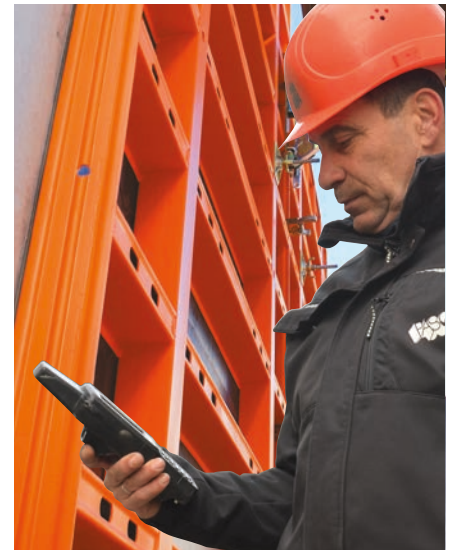

RFID technology optimized software PASCHAL Ident

The PASCHAL Ident Technology gives uniqueness to any equipped formwork panel\*. The herewith guaranteed clear unmistakable identification is the imperative precondition for leasing.

Advantages of the use of RFID technology

- Support of business processes
- Permanent inventory
- Simplified investment management
- Improved traceability

Refitting of construction equipment with RFID technology is possible

Product advantages finance leasing:

- No activation in the balances required (German accounting)
- No immediate outflow of liquidity by the acquisition and payment of the entire purchase price
- Financing by the "Pay-as-you-earn"-principle is possible
- Planning safety through fixed compensation fee and fixed utilisation time
- The use and market suitability of the leasing product is kept by the further utilisation of the investment object after termination of the leasing contract

\* All formwork panels of the LOGO.3 and the Modular Universal Formwork are equipped with RFID technology as standard.



# Concrete

Fresh concrete pressure





## Calculation for concrete pressure

Calculation of the fresh concrete pressure with the concrete pressure calculator:

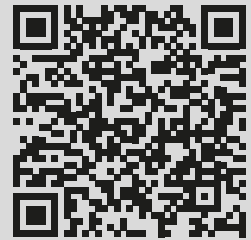

## Fresh concrete pressure on vertical formwork

When concreting vertical walls, the individual formwork elements and their anchors are loaded horizontally by the fresh concrete pressure. The size of the fresh concrete pressure to be applied is regulated in DIN 18218, issue 2010-01 for various parameters.

In Figure 1, the distribution of fresh concrete pressure is presented for the concrete height  $H$ . Starting from the concrete surface, the fresh concrete pressure increases evenly downwards to the hydrostatic pressure height  $h_s$ . The hydrostatic pressure height  $h_s$  can be determined with the maximum fresh concrete pressure  $\sigma_{hk,max}$  and the specific weight  $\gamma_c$  of the fresh concrete to  $= \sigma_{hk,max} / \gamma_c$ . For the difference between the hydrostatic pressure height and the height of the concrete after reaching the end of setting  $h_E$ , a constant pressure course is assumed. If the total height of the concrete  $H$  is greater than  $h_E$ , the fresh concrete pressure develops into a moving load for the formwork height.

The hydrostatic fresh concrete pressure  $\sigma_{hk,max,hydr} = \gamma_c \cdot H$  is, when pouring in the concrete against the direction of rise (from above), the highest possible value of the fresh concrete pressure. Even if, due to unfavourable influences, a higher value subsequently results for the fresh concrete pressure, it prevails as the upper limit.

In DIN 18218, the fresh concrete pressure is stated as a characteristic value of the influence  $\sigma_{hk}$ . The design value  $\sigma_{hd} = \gamma_F \cdot \sigma_{hk}$  is to be applied for the design of the formwork and scaffolding including anchors. The partial safety factor  $\gamma_F$  for proof in ultimate limit state is 1.5 in the case of an unfavourable influence. In the case of a favourable influence, the partial safety factor of the fresh concrete pressure  $\gamma_F = 1.0$  is to be applied.

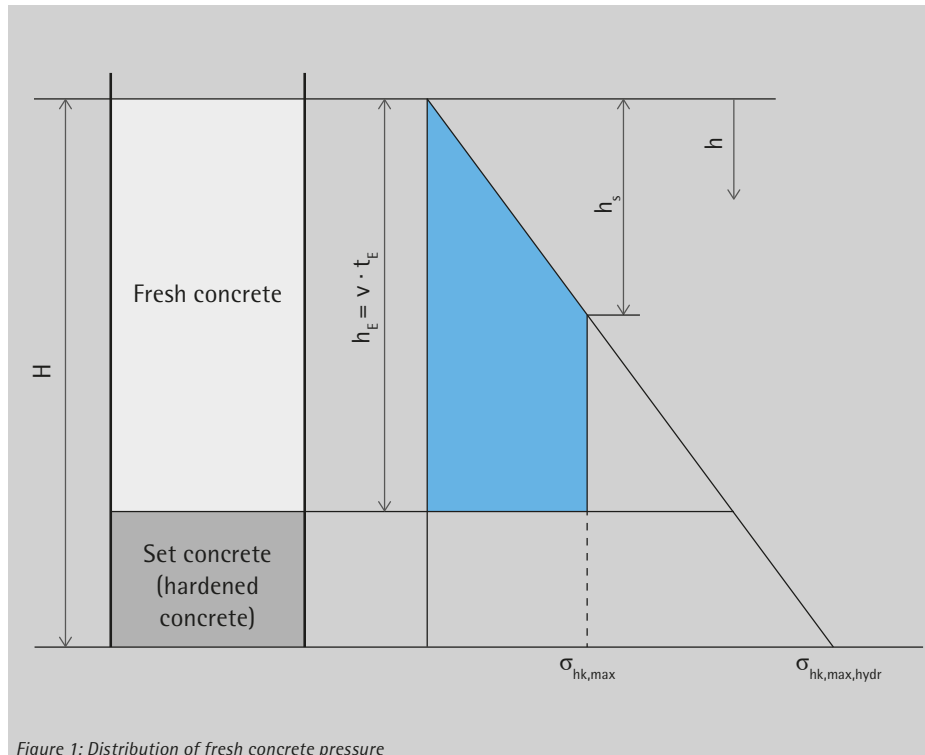

Figure 1: Distribution of fresh concrete pressure



Vineyard Franz Keller, D- Oberbergen; Implen Bau GmbH, D-Rümmingen



Concrete is divided into seven classes according to its consistency in line with DIN EN 206-1, DIN 1045-2 and DAFStb guidelines.

Consistency class	Flow diameter [mm]
F1 - hard (KS, K1)	≤ 340
F2 - plastic (KP, K2)	350 - 410
F3 - soft (KR, K3)	420 - 480
F4 - very soft (KF)	490 - 550
F5 - flowable	550 - 620
F6 - very flowable	≥ 630
SCC - self-compacting	≥ 700

*Table 1: Consistency classes flow diameter*

The characteristic values of the lateral fresh concrete pressure  $\sigma_{hk,max}$  can be calculated for the various consistency classes according to *Table 2* depending on the rate of rise.

Consistency class	Maximum fresh concrete pressure when poured in opposite direction to the rise in level (from above) $\sigma_{hk,max}$ [kN/m <sup>2</sup> ]
F1	$(5 \cdot v + 21) \cdot K1 \geq 25$
F2	$(10 \cdot v + 19) \cdot K1 \geq 25$
F3	$(14 \cdot v + 18) \cdot K1 \geq 25$
F4	$(17 \cdot v + 17) \cdot K1 \geq 25$
F5	$25 + 30 \cdot v \cdot K1 \geq 30$
F6	$25 + 38 \cdot v \cdot K1 \geq 30$
SCC	$25 + 33 \cdot v \cdot K1 \geq 30$

v pouring rate [m/h]  
K1 Factor for considering the setting behaviour according to *Table 3*

*Table 2: Characteristic values of maximum lateral fresh concrete pressure*

The influence of the setting behaviour on the fresh concrete pressure is taken into consideration by the factor K1 according to *Table 3*.

Consistency class	Factor K1			
	End of setting $t_E = 5$ h	End of setting $t_E = 10$ h	End of setting $t_E = 20$ h	General <sup>b</sup>
F1 <sup>a</sup>	1,0	1,15	1,45	$1 + 0,03 \cdot (t_E - 5)$
F2 <sup>a</sup>	1,0	1,25	1,80	$1 + 0,053 \cdot (t_E - 5)$
F3 <sup>a</sup>	1,0	1,40	2,15	$1 + 0,077 \cdot (t_E - 5)$
F4 <sup>a</sup>	1,0	1,70	3,10	$1 + 0,14 \cdot (t_E - 5)$
F5, F6, SCC	1,0	2,00	4,00	$t_E / 5$

<sup>a</sup> applies for concrete sections with a height H of up to 10 m

<sup>b</sup> applies for  $5 \text{ h} \leq t_E \leq 20 \text{ h}$ ;  $t_E$  in h

*Table 3: Factors K1 for considering the setting behaviour*





The end of setting  $t_e$  of fresh concrete is determined by its compound and temperature conditions and must be determined at the first examination. For concrete with strength class of at least C20/25 and without using retarders, the setting times can be estimated from the following empirical values:

#### Estimation of the end of setting

##### $t_e = 5$ hours for concrete

- with "fast" strength development according to DIN EN 206-1 and concrete temperatures of more than +15°C
- with "average" strength development and concrete temperatures of more than +20°C

##### $t_e = 7$ hours for concrete

- with "fast" strength development according to DIN EN 206-1 and concrete temperatures of more than +10°C
- with "average" strength development and concrete temperatures of more than +15°C
- with "slow" strength development and concrete temperatures of more than +20°C

The equations in *Table 2* take the following assumptions as a basis:

- The gross weight of the fresh concrete is  $\gamma_c = 25 \text{ kN/m}^3$ .
- The actual end of setting of the fresh concrete poured into the formwork does not exceed  $t_e$ .
- The fresh concrete of consistency classes F1 ÷ F6 is compacted with internal vibrators.
- The formwork is leak proof.
- The average rate of rise  $v$  at every point is 7,0m/h at the most when using concrete of consistency classes F1 ÷ F4.
- The concrete is poured against the direction of rise (from above).

If the fresh concrete gross weight deviates from  $\gamma_c = 25 \text{ kN/m}^3$ , the determined fresh concrete pressure  $\sigma_{hk,max}$  must be multiplied by factor  $K_2 = \gamma_c / 25$ .

$\gamma_c$ [kN/m <sup>3</sup> ]	K2
10	0,40
15	0,60
20	0,80
25	1,00
30	1,20
35	1,40
40	1,60

*Table 4: Factor K2 for converting the fresh concrete gross weight deviating from 25kN/m<sup>3</sup>*





Gare Pont Rouge, L- Luxembourg; Consortium „TRALUX and Lux TP S.A.“, L- Luxembourg



„Betoanose“ leisure and youth centre, D-Berlin-Friedrichsfelde; E & W BauTec Gbr; Photo: Alexander Blumhoff, alexander-blumhoff.com

If the fresh concrete temperature  $T_{c,placing}$  does not correlate with the reference temperature  $T_{c,Ref}$ , which forms the basis of determining the end of setting  $t_E$ , the fresh concrete pressure must be adapted. In doing so, the fresh concrete temperature may not deviate from the reference temperature in the case of concrete of the consistency classes F1 to F4 by more than 10 K and in the case of F5, F6 and SCC, by no more than 5 K.

If the fresh concrete temperature exceeds the reference temperature  $\sigma_{hk,max}$  when pouring in the concrete  $T_{c,placing}$ , the fresh concrete pressure may be reduced by 3% per 1K temperature difference, by 30%, however, at the most.

If the fresh concrete temperature is lower than the reference temperature  $T_{c,Ref}$  when pouring in the concrete  $T_{c,placing}$ , or if a higher fresh concrete temperature than  $T_{c,Ref}$  cannot be maintained, the fresh concrete pressure  $\sigma_{hk,max}$  must be increased by 3% per 1 K temperature difference in the case of consistency classes F1 to F4 and by 5% per 1K temperature difference in the case of consistency classes F5,F6 and SCC.

If the concrete is inserted from below, at least the hydrostatic fresh concrete pressure in relation to the filler must be applied for the concrete pressure  $\sigma_{hk,max}$  and not exceed the concrete level of 3.5 m.

For the exact determination of the available fresh concrete pressure or the tensile force on the tie rod, pressure measuring devices can be assembled at the tie point between the formwork element and the plate with ball and socket joint.

The value to be read corresponds with the available tensile force on the tie rod. This can be compared the tensile force permitted on the tie rod.

The actual available fresh concrete pressure can be calculated from the available tensile force and the area of influence impacting the tie point.

## Example calculations

In order to demonstrate the procedure for determining the fresh concrete pressure and the effects of deviating influencing factors, three examples are shown here.

Standards	Concrete height/wall height: $H = 4,0\text{m}$ Consistency: F3 Rate of rise: $v = 3,0\text{m/h}$ End of setting: $t_E = 5\text{h}$ $T_{c,placing} = T_{c,Ref}$ Fresh concrete gross weight $\gamma_c = 25\text{kN/m}^3$	Concrete height/wall height: $H = 4,0\text{m}$ Consistency: F4 Rate of rise: $v = 3,0\text{m/h}$ End of setting: $t_E = 5\text{h}$ $T_{c,placing} = 20^\circ\text{C}; T_{c,Ref} = 25^\circ\text{C}$ Fresh concrete gross weight $\gamma_c = 25\text{kN/m}^3$	Concrete height/wall height: $H = 2,5\text{m}$ Consistency: F3 Rate of rise: $v = 4,0\text{m/h}$ End of setting: $t_E = 10\text{h}$ $T_{c,placing} = T_{c,Ref}$ Fresh concrete gross weight $\gamma_c = 25\text{kN/m}^3$
	$K1 = 1,0$ $\sigma_{hk,max} = (14 \cdot v + 18) \cdot K1 \geq 25$ $\sigma_{hk,max} = (14 \cdot 3,0 + 18) \cdot 1,0 = 60\text{kN/m}^2$ $h_s = 60 / 25 = 2,4\text{m}$ $h_s \leq H \checkmark$	$K1 = 1,0$ $\sigma_{hk,max} = (17 \cdot v + 17) \cdot K1 \geq 25$ $\sigma_{hk,max} = (17 \cdot 3,0 + 17) \cdot 1 = 68\text{kN/m}^2$ $\Delta T = 20 - 25 = 5\text{K}$ Increase by $5 \cdot 3\% = 15\%$ $\sigma_{hk,max} = 68 \cdot 1,15 \approx 78\text{kN/m}^2$ $h_s = 78 / 25 = 3,12\text{m}$ $h_s \leq H \checkmark$	$K1 = 1,4$ $\sigma_{hk,max} = (14 \cdot v + 18) \cdot K1 \geq 25$ $\sigma_{hk,max} = (14 \cdot 4,0 + 18) \cdot 1,4 \approx 104\text{kN/m}^2$ $h_s = 104 / 25 = 4,16\text{m}$ $h_s \geq H \rightarrow \sigma_{hk,max,hydr}$ is decisive $\sigma_{hk,max,hydr} = \gamma_c \cdot H$ $\sigma_{hk,max,hydr} = 25 \cdot 2,5 = 62,5\text{kN/m}^2$

The attachment to DIN 18218 contains diagrams for various ends of setting  $t_E$  from which the highest values of the fresh concrete pressure can be read. Here, the procedure is shown based on example 1.

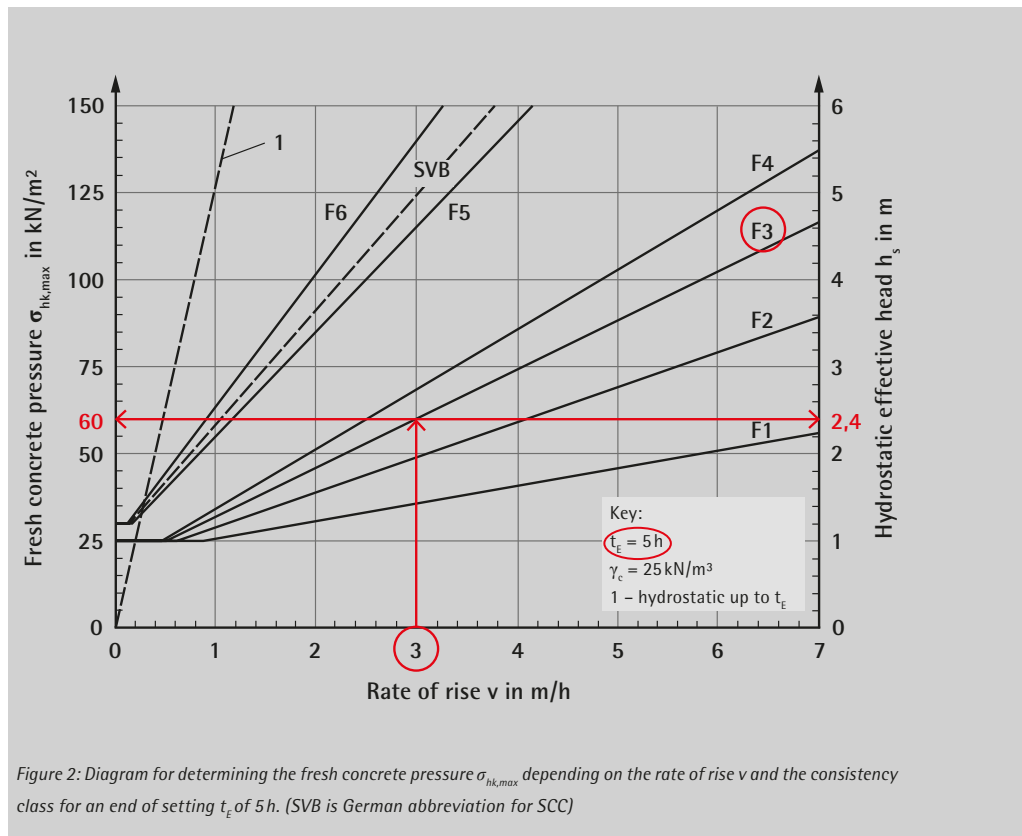







# Sales

Sales organisation





## **Products, Advice and Service: Readily available for effective construction work**

Effective construction work relies on "intelligent" components and tools. They must be easy to ship, be on site quickly and ready for use in no time. PASCHAL offers its clients immediate availability on an international scale: this includes consulting and customer services. All activities are coordinated from the HQ of PASCHAL-Werk G.Maier GmbH, which is located in Steinach, Southern Germany. The PASCHAL group has several branch offices in Germany, international subsidiaries, Representative offices and numerous Trade Partners. This represents a well-organized service network covering all aspects of concrete construction:

First of all competent consultants and well-founded product concepts, Trade Partners in your local region offering dependable supply service and reliable on-site staff briefing. But for your special convenience, PASCHAL can always be accessed by clients and partners via a clearly defined contact person. This PASCHAL consultant organizes everything needed around the PASCHAL products.



## International

### A Germany

PASCHAL-Werk G. Maier GmbH  
Stammwerk Steinach  
Kreuzbühlstraße 5  
D-77790 Steinach  
Phone: +49 78 32 71 0  
Fax: +49 78 32 71 209  
www.paschal.com  
service@paschal.com

### B Denmark

PASCHAL-Danmark A/S  
Bredskriftsvej 24  
DK-8210 Århus  
Phone: +45 86 24 45 00  
Fax: +45 86 24 56 01  
www.paschal.dk  
info@paschal.dk

PASCHAL-Danmark A/S  
Ejby Industrivej 122  
DK-2600 Glostrup  
Phone: +45 44 84 46 00  
Fax: +45 44 84 46 66  
www.paschal.dk  
info@paschal.dk

### C France

PASCHAL SARL  
70, Avenue Albert Einstein  
Z.I. de Château d'Eau  
F-77554 Moissy Cramayel Cedex  
Phone: +33 1 64 13 11 11  
Fax: +33 1 64 13 11 00  
www.paschal.fr  
commercial@paschal.fr

### D Czech Republic

PASCHAL s.r.o.  
Vyšehradská 23  
CZ-128 00 Praha 2  
Phone: +420 221 594 594  
Fax: +420 221 594 592  
www.paschal.cz  
info@paschal.cz

PASCHAL s.r.o.  
Sklad Beroun  
Lidická ulice 869  
CZ-226 01 Beroun  
Phone/Fax: +420 311 626 623  
www.paschal.cz  
beroun@paschal.cz

PASCHAL s.r.o.  
Sklad Olomouc  
U Panelárny 1  
CZ-772 00 Olomouc  
Phone/Fax: +420 585 313 476  
www.paschal.cz  
olomouc@paschal.cz

### E Switzerland

PASCHAL AG  
Leuholz 21  
CH-8855 Wangen / SZ  
Phone: +41 55 440 80 87  
Fax: +41 55 440 80 71  
www.paschal.ch  
info@paschal.ch

### F Bahrain

PASCHAL Concrete Forms Co. W.L.L.  
Bahrain International Investment Park  
P.O. Box 50510, Hidd  
Hidd 115, Avenue 19, Bldg. 96  
Kingdom of Bahrain  
Phone: +973 17 67 25 80  
Fax: +973 17 67 25 70  
www.paschal.com  
paschal@batelco.com.bh





**G Dubai**

PASCHAL EMIRATES Co. L.L.C.  
 Formwork and Scaffolding  
 P.O.Box 638  
 Marrakesh Street  
 Umm Ramool/Rashidiya  
 Dubai, U.A.E.  
 Phone: +971 4 286 11 39  
 Fax: +971 4 286 11 49  
 www.paschal.com  
 paschal@emirates.net.ae

**H India**

PASCHAL Form Work (India) Pvt. Ltd.  
 Application & Sales Center  
 Plot 67, Prasuna House - 1st floor,  
 Opp: D'Mart Super Market  
 Kavuri Hills, Madhapur  
 Hyderabad - 500033, India  
 Phone: +91 40 48526336  
 www.paschalindia.com  
 service@paschalindia.com

PASCHAL Form Work (India) Pvt. Ltd.  
 Registered Office  
 Sy.No.208-1&2, Bayyavaram (Village)  
 Kasimkota (Mandal), Anakapalli  
 Visakhapatnam Dist. 531031  
 Andhra Pradesh, India  
 Phone: +91 89 24 30 52 22  
 www.paschalindia.com  
 service@paschalindia.com

**1 Albania**

KONTAKT Sh.p.k.  
Rr. Frosina Plaku Nr. 40  
AL-1023 Tirana  
Phone: +355 42 225 338  
www.kontakt.al  
info@kontakt.al

**2 Belgium**

DBS bekisting nv  
Industriepark zone II  
Zevensterrestraat 13  
B-9240 Zele  
Phone: +32 52 45 82 80  
Fax: +32 52 45 82 85  
www.dbs-bekisting.be  
info@dbs-bekisting.be

**3 Bolivia**

ARMAQ LTDA  
Av. El Trompillo No. 660  
BO-Santa Cruz  
Phone: +591 3 3584203  
www.armaq.com.bo  
info@armaq.com.bo

**4 Lithuania**

Prorentus Ltd.  
Pramonės str.23  
LT-35114 Panevežys  
Phone: +370 45 40 10 46  
Fax: +370 45 40 10 47  
www.prorentus.lt  
info@prorentus.lt

**5 Martinique**

LOCAPRESS SAS  
Bois Rouge  
MQ-97224 Ducos  
Phone: +596 42 01 01  
Fax: +596 42 01 10  
www.locapresssas.wixsite.com/  
locapress-ducos-972  
ymt@mtd-mq.fr

**6 New Caledonia**

Coffrapac Nouvelle  
B.P. 1379  
Quartier Latin Dock Ducos  
NC-98845 Noumea Nelle Caledonie  
Phone: +687 76 69 99  
Fax: +687 25 43 21  
coffrapac@lagoon.nc

**7 Netherlands**

De Hon Bekistingstechniek B.V.  
De Steven 47  
NL-9206 AX Drachten  
Phone: +31 512 551 000  
www.de-hon.nl  
info@de-hon.nl

**8 Poland**

PALISANDER Sp.z.o.o  
ul. Zaczerlańska 17  
PL-16-070 Choroszcz  
Phone: +48 85 67 68 159  
Fax: +48 85 67 68 160  
www.palisander.com.pl  
biuro@palisander.com.pl

PALISANDER Sp.z.o.o  
Świerkówki 26A  
PL-64-605 Świerkówki  
Phone: +48 61 63 90 180  
Fax: +48 60 58 24 111  
www.palisander.com.pl  
zachod@palisander.com.pl

PALISANDER Sp.z.o.o  
ul. Rozwojowa 25  
PL-41-103 Siemianowice Śląskie  
Tel.: +48 32 35 30 629  
Fax: +48 66 56 00 003  
www.palisander.com.pl  
poludnie@palisander.com.pl

PALISANDER Sp.z.o.o  
ul. Dekarska 56  
PL-83-031 Rusocin  
Phone: +48 58 58 04 849  
Fax: +48 601 266 102  
www.palisander.com.pl  
polnoc@palisander.com.pl



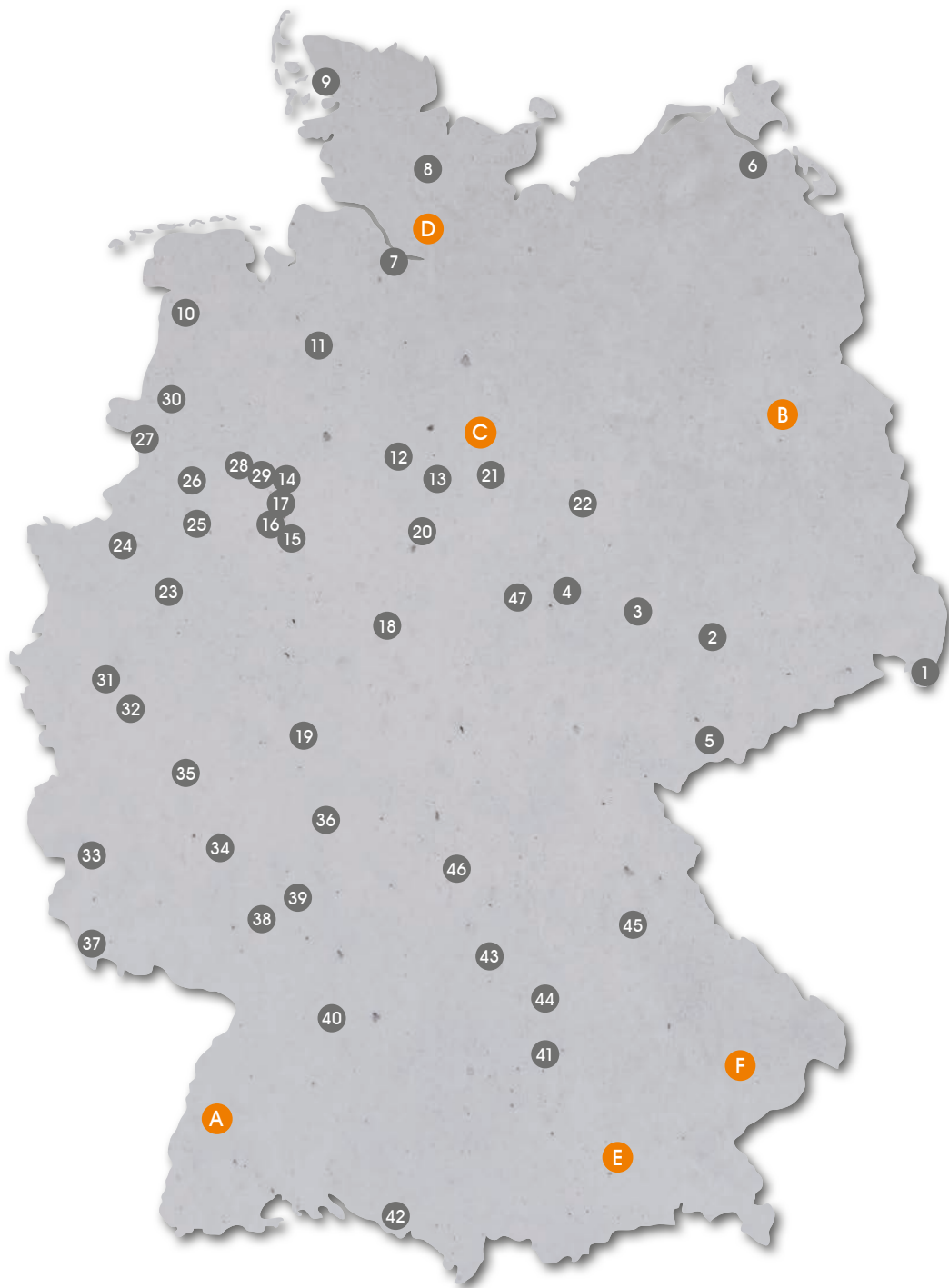

## Germany

### A Steinach

PASCHAL-Werk G. Maier GmbH · Stammwerk Steinach  
 Kreuzbühlstraße 5 · 77790 Steinach  
 Phone: +49 7832 71-0 · Fax: +49 7832 71-209  
 www.paschal.com · service@paschal.com

### D Hamburg

PASCHAL-Werk G. Maier GmbH · Service-Center Hamburg  
 Max-Weber-Straße 27-31 · 25451 Quickborn  
 Phone: +49 4106 73065 · Fax: +49 4106 75415  
 www.paschal.com · service-hamburg@paschal.de

### B Berlin

PASCHAL-Werk G. Maier GmbH · Niederlassung Berlin  
 Grenzgrabenstraße 13 · 13053 Berlin  
 Phone: +49 30 981957-0 · Fax: +49 30 981957-23  
 www.paschal.com · service-berlin@paschal.de

### E Munich

PASCHAL-Werk G. Maier GmbH · Niederlassung München  
 Grafinger Straße 29 · 85567 Taglaching b. München  
 Phone: +49 8092 868298-5 · Fax: +49 8092 868298-7  
 www.paschal.com · service-muenchen@paschal.de

### C Gifhorn

PASCHAL-Werk G. Maier GmbH · Niederlassung Gifhorn  
 Nordhoffstraße 2 · 38518 Gifhorn  
 Phone: +49 5371 58898-0 · Fax: +49 5371 58898-25  
 www.paschal.com · service-gifhorn@paschal.de

### F Arnstorf

PASCHAL-Werk G. Maier GmbH · Niederlassung Niederbayern  
 Eggenfeldener Straße 38 a · 94424 Arnstorf  
 Phone: +49 8723 1440 · Fax: +49 8723 3568  
 www.paschal.com · service-arnstorf@paschal.de

- 1** Rumpf + Schuppe GmbH  
Hirschfelder Ring 10  
02763 Zittau  
Phone: +49 3583 7751-0  
Fax: +49 3583 7751-13  
www.rumpf-schuppe.de  
info@rumpf-schuppe.de
- 2** B.B.F. Baumaschinen, Bauser-  
vice und Fahrzeuge Handels- und  
Vermietungs-GmbH  
Lausicker Straße 3  
04668 Grimma  
Phone: +49 3437 995-3  
Fax: +49 3437 995-419  
www.bbf-bauservice.de  
info@bbf-bauservice.de
- 3** Odenwälder  
Baumaschinen GmbH & Co. KG  
Weißenfeler Straße 72b  
06217 Merseburg  
Phone: +49 3461 82602-1  
Fax: +49 3461 82602-0  
www.baugeraetecenter.de  
miete.mq@baugeraetecenter.de
- 4** Kurt König  
Baumaschinen GmbH  
Oststraße 3  
06526 Sangerhausen  
Phone: +49 3464 574859  
Fax: +49 3464 574244  
www.kurt-koenig.de  
info@kurt-koenig.de
- 5** B.B.F. Baumaschinen, Bauser-  
vice und Fahrzeuge Handels- und  
Vermietungs-GmbH  
Karlsbader Straße 1  
08321 Zschorlau  
Phone: +49 3771 4101-0.  
Fax: +49 3771 4101-20  
www.bbf-bauservice.de  
zschorlau@bbf-bauservice.de
- 6** BAUFA Nord-Ost GmbH  
Baumaschinen und  
Servicegesellschaft mbH  
Helmshäger Straße 3+8  
17489 Greifswald  
Phone: +49 3834 5855-0  
Fax: +49 3834 5855-55  
www.baufa-nord-ost.de  
info@baufa-nord-ost.de
- 7** Krause Baumaschinen -  
Baugeräte GmbH  
Rüstjer Weg 2  
21739 Dollern  
Phone: +49 4163 3911  
Fax: +49 4163 2889  
info@krause-baumaschinen.de
- 8** MK Baubedarf Nord GmbH  
Oderstraße 52  
24539 Neumünster  
Phone: +49 4321 8091  
Fax: +49 4321 84299  
www.mk-baubedarf.de  
info@mk-baubedarf.de
- 9** Heinrich Jensen e.K.  
Baumaschinen - Baugeräte  
Gress-Straße 12  
25821 Bredstedt  
Phone: +49 4671 2920  
Fax: +49 4671 2262  
baumaschinen-jensen@t-online.de
- 10** Vernhold GmbH  
Baumaschinen - Baugeräte  
Kupferstraße 1  
26789 Leer  
Phone: +49 491 7028  
Fax: +49 491 72062  
www.vernhold-baumaschinen.de  
info@vernhold-baumaschinen.de
- 11** Stelster GmbH  
Bautechnik  
Senator-Allenheiligen-Straße 1  
28197 Bremen  
Phone: +49 421 527166-0  
Fax: +49 421 527166-99  
www.stelster-bautechnik.de  
mail@stelster-bautechnik.de
- 12** Kurt König  
Baumaschinen GmbH  
Nemndorfer Straße 2  
30952 Ronnenberg OT Empelde  
Phone: +49 511 9463970  
Fax: +49 511 461924  
www.kurt-koenig.de  
info@kurt-koenig.de
- 13** Kurt König  
Baumaschinen GmbH  
Porschestraße 27  
31135 Hildesheim  
Phone: +49 5121 697724-0  
Fax: +49 5121 697724-9  
www.kurt-koenig.de  
info@kurt-koenig.de
- 14** Heinrich Grotemeier GmbH  
& Co. KG  
Teichstraße 29  
32257 Bünde  
Phone: +49 5223 1660  
Fax: +49 5223 166227  
www.grotemeier.de  
info@grotemeier.de
- 15** Heinrich Grotemeier GmbH  
& Co. KG  
Rudolf-Diesel-Straße 19  
33178 Borcheln  
Phone: +49 5251 398800-4  
Fax: +49 5251 398800-5  
www.grotemeier.de  
paderborn@grotemeier.de
- 16** Stelster GmbH  
Bautechnik  
Schinkenstraße 2  
33415 Verl / Sürenheide  
Phone: +49 5246 50307-0  
Fax: +49 5246 50307-199  
www.stelster-bautechnik.de  
mail@stelster-bautechnik.de
- 17** Heinrich Grotemeier GmbH  
& Co. KG  
Ziegelstraße 90 A  
33609 Bielefeld  
Phone: +49 521 287195  
Fax: +49 521 27996  
www.grotemeier.de  
bielefeld@grotemeier.de
- 18** Kurt König  
Baumaschinen GmbH  
Söhrestraße 9  
34123 Kassel  
Phone: +49 561 57986-0  
Fax: +49 561 57986-79  
www.kurt-koenig.de  
info@kurt-koenig.de
- 19** Kurt König  
Baumaschinen GmbH  
Grüner Weg 1  
35418 Buseck  
Phone: +49 6408 5007-0  
Fax: +49 6408 5007-79  
www.kurt-koenig.de  
info@kurt-koenig.de
- 20** Kurt König  
Baumaschinen GmbH  
Grimselstraße 25  
37574 Einbeck  
Phone: +49 5561 7901-0  
Fax: +49 5561 7901-99  
www.kurt-koenig.de  
info@kurt-koenig.de
- 21** Kurt König  
Baumaschinen GmbH  
Kreuztor 9  
38126 Braunschweig  
Phone: +49 531 26474-0  
Fax: +49 531 26474-74  
www.kurt-koenig.de  
info@kurt-koenig.de
- 22** Kurt König  
Baumaschinen GmbH  
Königweg 1  
39171 Sülzetal  
Phone: +49 391 62512-0  
Fax: +49 391 62512-99  
www.kurt-koenig.de  
info@kurt-koenig.de
- 23** Elvermann GmbH  
Schaltechnik  
Kleyer Weg 37  
44149 Dortmund  
Phone: +49 231 6180499-0  
Fax: +49 231 6180499-1  
www.elvermann.de  
info@elvermann.de
- 24** Elvermann GmbH  
Schaltechnik  
Zur Reithalle 72-76  
46286 Dorsten-Lembeck  
Phone: +49 2369 9891-0  
Fax: +49 2369 9891-95  
www.elvermann.de  
info@elvermann.de
- 25** Vernhold GmbH  
Baumaschinen - Baugeräte  
Fuggerstraße 24  
48165 Münster  
Phone: +49 2501 92261-0  
Fax: +49 2501 92261-29  
www.vernhold-baumaschinen.de  
info@vernhold-baumaschinen.de
- 26** Hoffschulte-Kassens  
GmbH & Co. KG  
Hollefeldstraße 36  
48282 Emsdetten  
Phone: +49 2572 95304-7  
Fax: +49 2572 95304-8  
www.hoffschulte-kassens.de  
info@hoffschulte-kassens.de
- 27** Vernhold GmbH  
Baumaschinen - Baugeräte  
Katharinenstraße 7  
48529 Nordhorn  
Phone: +49 5921 16656  
Fax: +49 5921 73078  
www.vernhold-baumaschinen.de  
info@vernhold-baumaschinen.de
- 28** Vernhold GmbH  
Baumaschinen - Baugeräte  
Rheinstraße 113-115  
49032 Osnabrück  
Phone: +49 541 669050  
Fax: +49 541 682139  
www.vernhold-baumaschinen.de  
info@vernhold-baumaschinen.de
- 29** Heinrich Grotemeier GmbH  
& Co. KG  
Gut Stockum 23  
49143 Bissendorf  
Phone: +49 5402 641489-0  
Fax: +49 5402 641489-5  
www.grotemeier.de  
osnabrueck@grotemeier.de
- 30** Hoffschulte-Kassens  
GmbH & Co. KG  
Dieselstraße 37 - 39  
49716 Meppen/Ems  
Phone: +49 5931 803-0  
Fax: +49 5931 803-40  
www.hoffschulte-kassens.de  
info@hoffschulte-kassens.de



**31** P. HAHN GmbH & Co. KG  
Hermann-Seger-Straße 6-8  
50226 Frechen  
Phone: +49 2234 56061  
Fax: +49 2234 14988  
www.hahn-schalung.eu  
info@hahn-schalung.eu

**32** FUCHS Baumaschinen -  
Baugeräte GmbH  
Am Schützenhof 1  
53119 Bonn  
Phone: +49 228 661046  
Fax: +49 228 664433  
www.fuchs-baumaschinen.de  
service@fuchs-baumaschinen.de

**33** HSB Handels- und Servicege-  
sellschaft für Baumaschinen mbH  
Schweicher Str. 51  
54338 Schweich-Issel  
Phone: +49 6502 7520  
Fax: +49 6502 7420  
www.hsb-baumaschinen.de  
info@hsb-baumaschinen.de

**34** Troglauer GmbH  
Saarlandstraße 379a  
55411 Bingen-Dietersheim  
Phone: +49 6721 9736-0  
Fax: +49 6721 9736-50  
www.troglauer.net  
info@troglauer.net

**35** Helmut Jost GmbH  
Bautechnik  
In der Pützgewann 20  
56218 Mülheim-Kärlich  
Phone: +49 2630 96517-0  
Fax: +49 2630 96517-60  
www.jost-bautechnik.de  
info@jost-bautechnik.de

**36** Lothar Herrmann  
Baumaschinen GmbH  
Benzstraße 15  
63457 Hanau  
Phone: +49 6181 9573-0  
Fax: +49 6181 9573-25  
www.herrmann-baumaschinen.de  
info@herrmann-baumaschinen.de

**37** HSB Handels- und Servicege-  
sellschaft für Baumaschinen mbH  
Matthias-Erzberger Straße 9-11  
66806 Ensdorf  
Phone: +49 6831 9567-0  
Fax: +49 6831 9567-30  
www.hsb-baumaschinen.de  
info@hsb-baumaschinen.de

**38** Odenwälder Baumaschinen  
und Baugeräte GmbH  
Industriestraße 59  
67063 Ludwigshafen  
Phone: +49 621 67020-30  
Fax: +49 621 67020-50  
www.baugeraetecenter.de  
miete.lu@baugeraetecenter.de

**39** Odenwälder  
Baumaschinen GmbH  
Weinheimer Straße 58-60  
69509 Mörlenbach  
Phone: +49 6209 7181-22  
Fax: +49 6209 7181-00  
www.baugeraetecenter.de  
miete.mo@baugeraetecenter.de

**40** Elvermann GmbH  
Schaltechnik  
Im Sträßle 18  
71706 Markgröningen  
Phone: +49 7145 93600-0  
Fax: +49 7145 93600-1  
www.elvermann.de  
info@elvermann.de

**41** Mack GmbH  
Baumaschinen Baugeräte Bauelemente  
Schnödhofweg 27  
86666 Burgheim  
Phone: +49 8432 9485-0  
Fax: +49 8432 9485-10  
www.mack-baugeraete.de  
info@mack-baugeraete.de

**42** LECHLER | Heber  
Baubedarf - Schalungstechnik  
Waldesch 33  
88069 Tettngang  
Phone: +49 7542 52060  
Fax: +49 7542 53515  
www.lechler-augsburg.de  
info@heber-schalungstechnik.de

**43** BGU Baugeräte-Union GmbH  
& Co. Maschinenhandels KG  
Hardtstraße 9  
91522 Ansbach  
Phone: +49 981 96930-10  
Fax: +49 981 96930-30  
www.bgu.de  
info@bgu.de

**44** BGU Baugeräte-Union GmbH  
& Co. Maschinenhandels KG  
Dettenheimer Straße 1  
91781 Weißenburg  
Phone: +49 9141 8601-0  
Fax: +49 9141 8601-30  
www.bgu.de  
info@bgu.de

**45** Nonner & Weiß GmbH  
Schalungen - Baugeräte  
Max-Planck-Straße 3  
92224 Amberg  
Phone: +49 9621 6713-0  
Fax: +49 9621 6713-30  
www.nonner-weiss.de  
mail@nonner-weiss.de

**46** Odenwälder Handels GmbH  
Am Wachtelberg 28  
97273 Kürnach  
Phone: +49 9367 98850-0  
Fax: +49 9367 98850-10  
www.baugeraetecenter.de  
miete.ku@baugeraetecenter.de

**47** Kurt König  
Baumaschinen GmbH  
Friedrich-List-Straße 9  
99734 Nordhausen  
Phone: +49 3631 4765-0  
Fax: +49 3631 4765-79  
www.kurt-koenig.de  
info@kurt-koenig.de



# Register





**A**

Access hatch 172  
 Adjustable prop 57, 151, 214  
 Alu and steel wall Formwork LOGO combined 82  
**Alu-shoring-system GASS (see GASS too)** 176 ff., 224, 252  
**Alu Wall Formwork LOGO (see LOGO too)** 80 ff.  
 Application engineers 13, 15  
 AutoCAD (ATD) 8, 231, 237, 253

**B**

Baths and swimming pools 107  
 Beams 24, 31, 40, 42, 62, 143, 156, 183, 188, 192

**C**

CAD 8, 15, 231, 233, 236 f., 253  
 Certification 11  
 Chip 253  
 Circular column 32, 125, 130 ff., 201, 203, 223, 249  
**Circular column Formwork** 32, 130 ff., 201, 249  
 Circular Formwork with adjustable radii  
     (see Trapezoidal Girder Formwork) 96 ff., 248  
 Circular wall end 130 f., 201  
 Circular walls 30, 106  
 Civil engineering 29, 67, 94, 189, 236, 246 f.  
 Cleaning 14, 17  
 Climbing 8, 148 ff., 250 ff.  
**Climbing and Platforms** 8, 148 ff., 250 ff.  
     Carriage 151, 154, 158  
     Clevis shoe 151 ff., 159, 250 f.  
     Climbing brackets 149, 151  
     Climbing cone 149  
     **Climbing platform KBK 180** 149, 152, 158 f., 251  
     **Climbing system 200** 149, 151, 158, 250  
     **Climbing system 240** 149, 150, 157, 250  
     Climbing unit 150 f., 156, 250  
     Dam bracket SPK 270 154, 159  
     Klik-klak-beam 156  
     Lifting platforms 149, 156, 160  
     Parts list 160 f.  
     Protection and safety scaffold 152  
     Suspended scaffold 150 ff., 154, 156, 159  
     Trap 151 f., 158, 161  
     Working platform 150, 151, 152, 154, 156  
     Working scaffold 151  
 Climbing platform KBK 180 149, 152, 158 f., 251  
 Climbing platforms 150, 152  
 Clothoids 30

**Column Formwork** 32, 63, 124 ff., 223, 249  
     Circular column Formwork 130 ff., 249  
     Grip 126 ff., 249  
     with LOGO panels 137  
     with Modular panels 136  
 Columns 24, 28, 32, 40, 42, 60, 66, 124 ff., 249  
 Combi clamp 23, 43, 47, 49, 77, 81, 97, 200, 203  
 Combine 29, 42, 43, 56, 68, 107, 149, 164, 170, 200  
 Company history 7 f.  
**Compatibility** 200 ff.  
**Concrete pressure** 25, 40, 43, 50, 82, 87, 89, 101, 118, 126, 134, 206, 246 ff., 254 ff.  
 Concrete pressure DIN 18218 23, 39, 49, 81, 85, 93, 97, 117, 246 ff., 254 ff.  
 Concrete pressure SCC 257, 259, 260  
 Connection LOGO/Modular 200  
 Connection LOGO/Trapezoidal Girder Formwork 200  
 Connection panel 32, 133, 249  
 Consultant 9, 14 f., 263  
**Consumption material** 212 ff.  
 Cross girders 140 f.  
**Custom Formwork** 218 ff.  
 Custom Formwork Construction 23 f., 218 ff., 252

**D**

**Dam bracket SPK 270** 154 ff.  
 Dam Formwork 154 f.  
 DIN 18202 23, 39, 49, 81, 85, 93, 97, 117, 139, 246 ff.  
 DIN 18218 23, 39, 49, 81, 85, 93, 97, 117, 246 ff., 254 ff.  
 DIN EN ISO 11  
 DWG-Interface 232, 237  
 DXF-Interface 232, 237

**E**

Egg shape 30  
 Ellipses 30, 108

**F**

Fitter (see Formwork fitter) 13, 15, 107, 220, 224 f.  
 Folding mechanism 126 f., 173, 249, 251  
 Formwork drawing 15, 233, 236  
 Formwork fitter 13, 15, 107, 220, 224 f.  
 Formwork planning 8, 14, 231 ff., 253  
 Formwork technology 11  
 Foundation Formwork 23, 26, 40, 62  
 Foundation strap 23, 26, 37, 47, 62, 78  
 Full Service 14

**G**

Gardening and landscaping 248  
**GASS Aluminium shoring system** 176 ff., 252  
 Cantilever brackets 183  
 Ledger frames 180  
 Legs 180, 182, 183  
 Load carrying capacity 178  
 Main beam 183  
 Parts list 184 f.  
 Rocking base/head plate 185  
 Saddle beam 183, 185  
 Short link 182, 185  
 Technical Data 177  
 General overhaul 14, 17  
**Grip** 124 ff.  
 Folding mechanism 126, 127  
 Parts list 128 f.  
 Plastic coated plywood 125, 249  
 Guided factory tours 19

**H**

Half circular wall end 131, 201  
 Haunch girder 97, 105, 248  
 Hired equipment service 14, 16  
 Hiring logistics 16  
 Hook headed bolt 78, 180  
 Housing projects 28, 64  
 Hydrostatic pressure height 256

**I**

IFC-Inter face 232, 234, 253  
 Industrial construction 29, 66, 94, 246 f.  
 Isometry 237

**J**

Josef Maier 7

**L**

Large-size Formwork 24 f., 48 ff., 172, 246  
 Lift shafts 27, 66, 222  
**Lifting platforms** 156 ff.  
**Lightweight formwork NeoR** 38 ff.  
 Logistics 14, 16, 194, 236, 242  
**LOGO.3 + alu wall Formwork** 48 ff.  
 Alu + steel combined 82  
 Alu panels 58, 82 ff.  
 Climbing 49  
 Columns 60, 66, 137  
 Combination rail 57, 67  
 Concreting platform 68

Connecting pieces 116  
 Crane lifting clamp 71, 78  
 Foundation Formwork 62  
 Housing projects 64  
 Industrial construction 66  
 Locking screw 70, 72  
 LOGO.alu 80 ff.  
 Max. concrete pressure 49, 81  
 Midi-Panel 61  
 Multi clamp 58  
 Panel heights 49, 81  
 Panel widths 49, 81  
 Parts list 72 ff., 83  
 Plywood 49, 50, 55, 67, 81  
 Stop end 49, 59, 60, 62  
 Supporting/Brackets 55, 57,  
 Technical data 49, 81  
 Tolerances of deflection 49, 50, 81  
 Wedge clamp 58

**M**

Maier Josef 7  
 Main girder 140 ff.  
 Material list 15, 232 f., 253  
**Max. concrete pressure** 23, 39, 49, 81, 85, 93, 97, 117, 246 ff.,  
 254 ff.  
**Modular/GE Universal Formwork** 22 ff.  
 Beams 31  
 Columns 32, 136  
 Foundations 26  
 GE-clamp 25  
 Housing projects 28  
 Industrial construction 29  
 Keybolt 25  
 Max. concrete pressure 23  
 Panel connections 25  
 Panel heights 23, 246  
 Panel widths 23, 246  
 Panels 23, 246  
 Parts list 33 ff.  
 Plywood 23, 246  
 Round solutions 30  
 Shafts 28  
 Technical data 23, 246  
 Tolerances of deflection 23, 246  
**Modular column formwork adjustable** 134 ff.  
**Multiple Multi-functional working-platform** 168 ff.  
 Admissible load 169  
 Assembly 171  
 Compensations 173



Efficiency 170  
 Large-size Formwork 172  
 Parts list 174 ff.  
 Safety at work 170  
 Technical data 169  
 Trap 169, 172

## O

Oval columns 32, 130, 131, 249

## P

Partnership 9

### Parts List

Alu-shoring-system GASS 184 f.  
 Circular column Formwork 132 f.  
 Climbing and Platforms 157 ff.  
 Column Formwork Grip 128 f.  
 Compatibility 203  
 LOGO.3 72 ff.  
 LOGO.alu 83  
 Modular/GE 33 ff.  
 Multip Multi-functional working-platform 174 f.  
 PASCHAL Deck 145  
 Single sided Forming 210 f.  
 Slab edge brackets 147  
 Supports and consumables 214 ff.  
 Trapezoidal Girder Formwork TTR 109 ff.  
 Trapezoidal Girder Formwork TTK 114 f.  
 Trapezoidal Girder Formwork TTS 122 f.

### PASCHAL Deck Slab Formwork 140 ff., 250

Beams 143  
 Cross girders 140, 141  
 Main girder 140, 141  
 Parts list 145  
 Slab props 140, 144  
 Technical data 139  
 Wooden Girder H 20 140 ff., 250

### PASCHAL Ident 240 ff.

### PASCHAL Maturix 226 ff.

### PASCHAL-Plan 232 ff., 236 f.

### PASCHAL-Plan light 232 ff.

3D 232, 233, 234  
 Design module 232  
 DXF-Interface 232  
 Formwork planning 232, 233, 234  
 Manual editing 233  
 Material list 233  
 Phase 233  
 Planning 232, 233, 234  
 Warehouse management 232, 233, 234

Warehouse module 234

### PASCHAL-Plan pro 236 f.

2D 237  
 3D 236, 237  
 AutoCAD 237  
 DWG-Interface 237  
 DXF-Interface 237  
 IFC-Interface 237  
 Interfaces 237  
 Isometry 237  
 Object library 237  
 Planning 236, 237  
 Shoring systems 237  
 Supports 237

### PASCHAL TG 60 186 ff.

Pivot bearings 99

Planning 14, 227, 231 ff., 241

Plastic coated plywood Grip 126, 249

Plywood 17, 23, 25, 39, 41, 49, 50, 55, 65, 67, 81, 85, 97, 99, 100,  
 102, 105, 126, 130, 134, 136, 137, 139, 140, 246 ff.

Polygon 23, 30,

Polygonal 23, 30, 100

Precast parts 219

Project teams 14

Protection and safety scaffold 152

## Q

Quality management 11

Quality Protection Association Concrete Formworks GSV 11

## R

Rate of rise 257 ff.

Ready to use service 105

Renovation 14, 17

Rent 14, 16

Rental Formwork 14, 16

Rental park 16

Repair 14, 17

Reservoirs 94, 154, 237, 246, 247

## S

Sales organisation 262 ff.

SCC 257, 259

Secuset Lateral protection system 162 ff.

Self compacting concrete 257

Seminars 14, 19

Services 12 ff.

Service and Consultation 14 ff.

Software PASCHAL-Plan 232 ff.

Sewage plants 98, 99, 102, 103, 105, 131, 202, 203, 208

Shaft 27, 65, 106, 149, 156, 222, 246, 252  
 Shaft Formwork 27, 65, 222  
 Short link 400 GASS 182, 185  
**Single-sided forming** 204 ff.  
 Single-sided walls 209  
 Slab edge 139, 146 ff., 164, 165, 251  
**Slab edge Formwork** 146 ff.  
**Slab Formwork** (see PASCHAL Deck too) 138 ff.  
 Slab props 140, 141, 144, 145  
**Software** 230 ff.  
 Spacer channel 49, 59, 70, 78, 81, 82, 137  
 Special parts 222 ff.  
 Steel custom Formwork 220 ff.  
 Subsidiary company 263 ff.  
 Supporting jacks 204 ff.  
 Supports 16, 30, 55, 166, 190, 206, 207, 208, 212 ff.  
**Supports and consumption material** 212 ff.  
 Suspended scaffold 150 ff., 250 f.  
**System summary** 246 ff.

## T

### Technical Data

Alu-shoring-system GASS 177  
 Climbing installations 150, 151, 152, 156  
 LOGO.3 + alu 49, 81  
 Modular/GE 23  
 Multip 169  
 PASCHAL Deck 139  
 Slab edge Formwork 139  
 Trapezoidal Girder Formwork TTR 97  
 Trapezoidal Girder Formwork TTS 117  
 Ties 23, 26, 49, 52, 54, 60, 63, 67, 85, 94, 97, 101, 105, 106, 117, 172, 222, 246 ff.  
 Tolerances of deflection 23, 39, 43, 49, 50, 81, 85, 87, 93, 97, 101, 117, 139, 246 ff.  
 Trading partners 268 ff.  
 Training courses 14, 19  
**Trapezoidal Girder Formwork TTR, TTK, TTS 96 ff., 112 ff., 116 ff.**  
 Adjusting range 99, 118  
 Baths and swimming pools 107  
 Circular walls 106  
 Compensations 102, 110  
 Crane lifting eye 97, 104, 110, 111, 115, 117, 118, 121, 123  
 Extension 102, 104, 111, 115, 118, 123  
 Gardening and landscaping 248  
 Haunch girder 97, 105  
 Max. concrete pressure 97, 117, 118, 248  
 Non-circular curves and tapers 108  
 Parts list 109 ff., 114 f., 122 f.  
 Plywood 97, 99, 100, 248

Round and accurate dimensions 100  
 Segment dimensions 97, 117, 248  
 Segment heights 97, 117, 248  
 Segment widths 97, 117, 248  
 Steel facing (TTS) 116 ff., 248  
 Technical data 97, 117, 248  
 Telescopic girder 102  
 Ties 97, 101, 105, 106, 117  
 Tolerances of deflection 97, 101, 117, 248  
 Top forming times 105, 118  
 Tunnel 108, 121  
**TTK Circular Trapezoidal girder formwork with clamp connection** 112 ff.  
**TTR Circular Trapezoidal girder formwork** 96 ff.  
**TTS Circular Trapezoidal girder formwork with steel facing** 116 ff.  
 Tunnel 108, 224

## U

**Universal Formwork** (see Modular/GE) 22 ff.

## V

V-guide DW15 209

## W

Wall Formwork 22 ff., 38 ff., 48 ff., 80 ff., 84 ff., 92 ff.  
**Wall formwork LOGO.3** 48 ff.  
**Wall formwork LOGO.alu** 80 ff.  
**Wall formwork LOGO.pro** 84 ff.  
**Wall formwork LOGO.S** 92 ff.  
 Warehouse management 232, 233  
 Wood custom Formwork 220 ff.  
 Wooden Girder H 20 139 ff., 141  
 Working platform (see Multip) 168 ff.  
 Working safety 162 ff., 168 ff.  
 Working scaffold 151



